

~~RESTRICTED~~

TECHNICAL MANUAL }
 No. 9-705 }

WAR DEPARTMENT
 Washington, October 26, 1942

SCOUT CAR M3A1

Prepared under the direction of the
 Chief of Ordnance

CONTENTS

REGRADED UNCLASSIFIED BY
 AUTHORITY OF DOD DIR. 5200.1 R
 BY *Ames* ON *11/20/02*

PART I — OPERATING INSTRUCTIONS

	Paragraphs	Pages
SECTION I: Introduction	1-2	3-7
II: Description, operation and controls	3-8	8-21
III: Armament	9-13	22-26
IV: Inspection	14-19	27-34
V: Lubrication	20-25	35-41
VI: Care and preservation.....	26-32	42-45
VII: Tools and equipment on vehicle.....	33-37	46-48
VIII: Materiel affected by gas.....	38-41	49-51

PART II — ORGANIZATIONAL MAINTENANCE

IX: Scope of maintenance operations...	42-45	52-55
X: Organization spare parts and accessories	46-47	56
XI: Front axle	48-52	57-65
XII: Rear axle	53-57	66-72

SCOUT CAR M3A1

PART II — ORGANIZATIONAL MAINTENANCE (Cont.)

	Paragraphs	Pages
SECTION XIII: Body	58-60	73-78
XIV: Brake systems	61-69	79-98
XV: Clutch	70-74	99-102
XVI: Cooling system (gasoline engine powered vehicles)	75-81	103-117
XVII: Cooling system (Hercules Diesel engine)	82-89	118-125
XVIII: Cooling system (Buda Diesel engine)	90-97	126-128
XIX: Electrical system and accessories (gasoline engine powered vehicles)	98-115	129-174
XX: Electrical system and accessories (Diesel engine powered vehicles)	116-130	175-189
XXI: Engine (Hercules gasoline)	131-145	190-216
XXII: Engine (Hercules Diesel)	146-161	217-266
XXIII: Engine (Buda-Lanova Diesel).....	162-174	267-292
XXIV: Exhaust system	175-176	293
XXV: Frame	177-180	294
XXVI: Fuel system and accessories (gaso- line engine powered vehicles).....	181-187	295-305
XXVII: Bosch fuel injection system (Hercules Diesel engine).....	188-194	306-322
XXVIII: Bosch fuel injection system (Buda Diesel engine).....	195-202	323-328
XXIX: Instruments and gages	203-205	329-332
XXX: Propeller shafts	206-208	333-334
XXXI: Springs and shock absorbers	209-213	335-338
XXXII: Steering gear	214-217	339-346
XXXIII: Transfer case	218-221	347-350
XXXIV: Transmission	222-225	351-358
XXXV: Wheels	226-229	359-362
XXXVI: Shipment and storage.....	230-233	363-368
XXXVII: References	234-235	369-370
INDEX.....		371-386

PART I — OPERATING INSTRUCTIONS

Section I

INTRODUCTION

	Paragraph
Scope	1
Data	2

1. SCOPE.

a. This manual is published for the information and guidance of the using arms and services.

b. In addition to a description of the Scout Car M3A1, this manual contains technical information required for the identification, use, and care of the material.

c. Specific information for the guidance of operating personnel (crew) is contained in part I. Information chiefly for the guidance of organizational maintenance personnel (using arm's unit mechanics) is contained in part II.

d. Disassembly, assembly, and such repairs as may be handled by using arms personnel will be undertaken only under the supervision of an officer or the chief mechanic.

e. In all cases where the nature of the repair, modification, or adjustment is beyond the scope or facilities of the unit, the responsible ordnance service should be informed in order that trained personnel with suitable tools and equipment may be provided, or proper instructions issued.

2. DATA.

Wheelbase	131 in.
Length, over-all	221.25 in.
Width, over-all	71.25 in.
Height, over-all	79.25 in.
Tread — front	63.25 in.
rear	65:25 in.
Capacity, crew	8
Center of gravity above ground	30.25 in.
Bridging limit — approach angle	37 deg.
departure angle	35 deg.
Minimum turning circle diameter	57 ft.
Ground clearance (transfer case)	15.75 in.
Fording depth (muffler)	24 in.
Towing facilities — front	Tow hooks
rear	Pintle
Pintle height	28.25 in.

SCOUT CAR M3A1

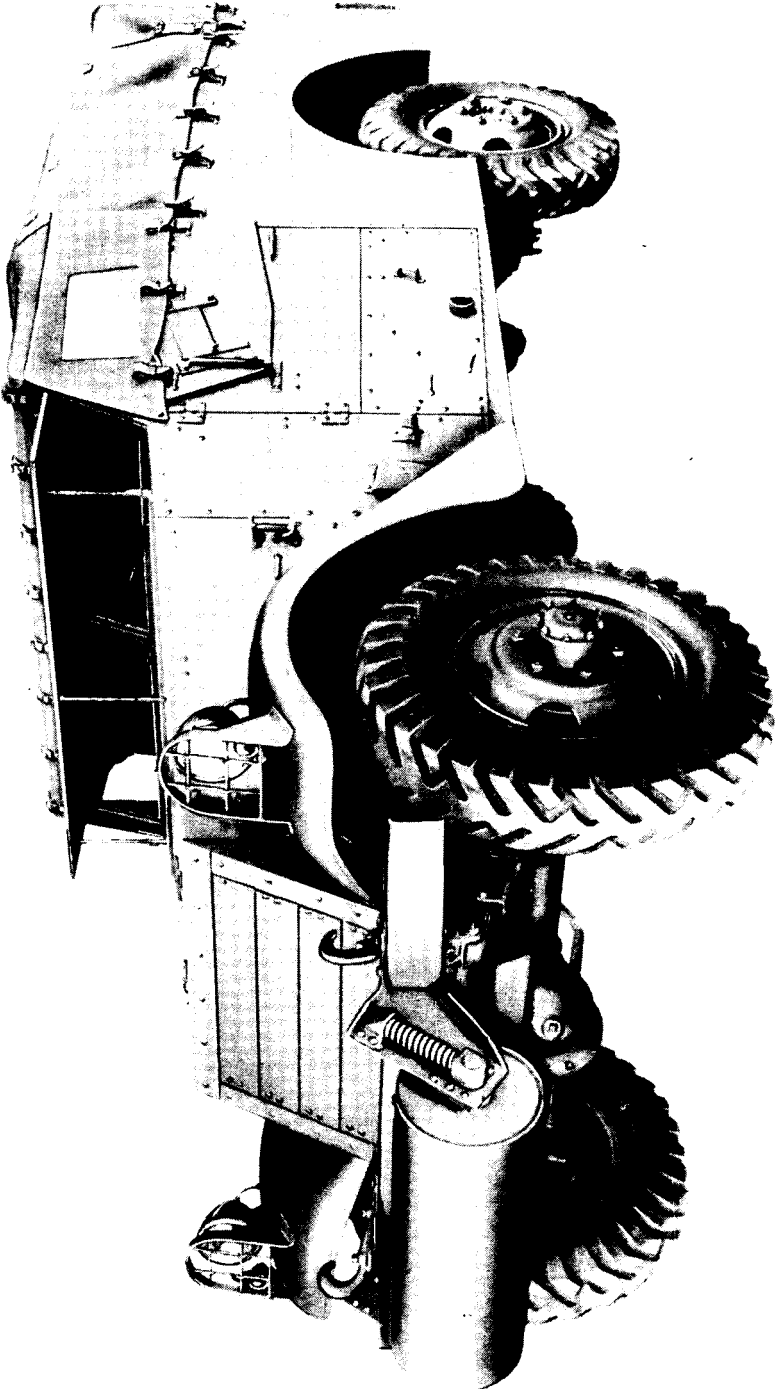

RA PD 3220

Figure 1 — Left Front View

INTRODUCTION

RA PD 3221

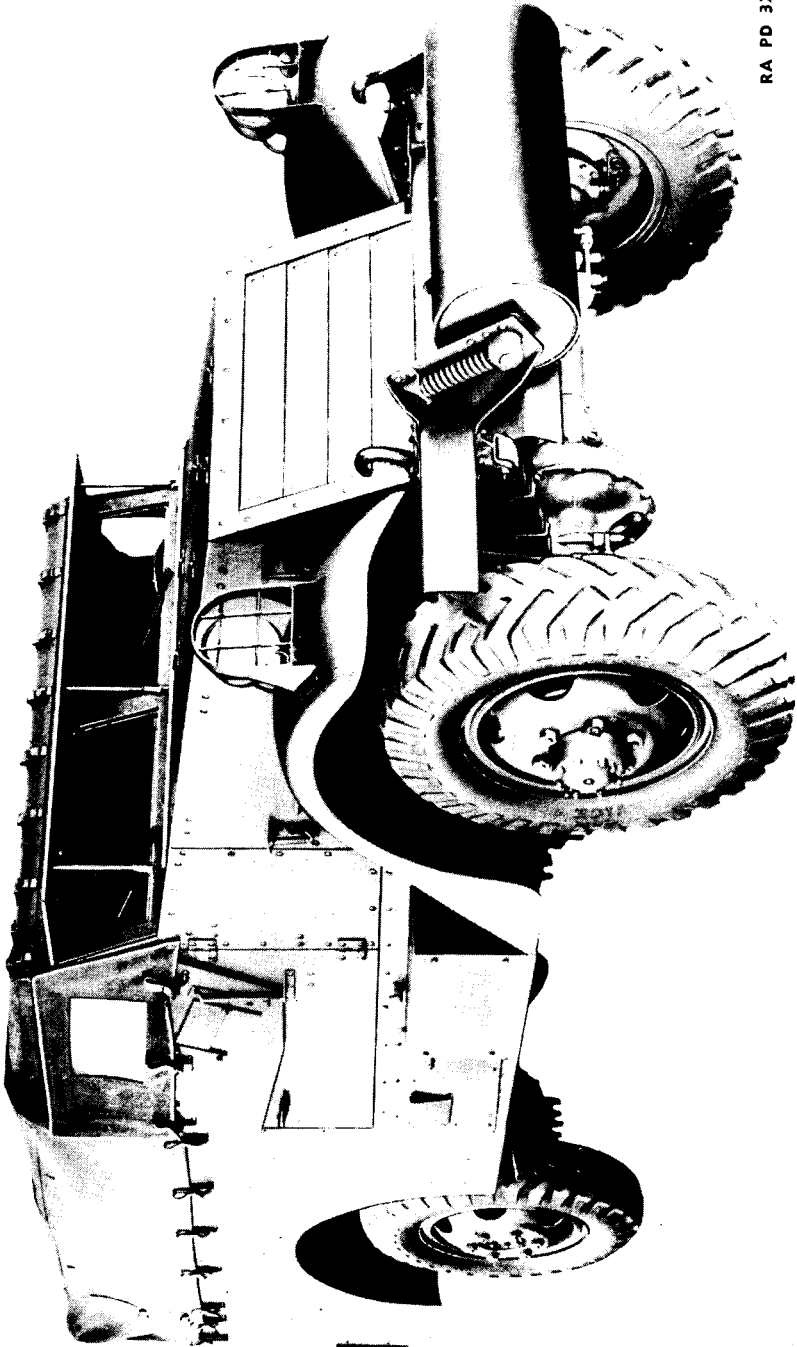

Figure 2 — Right Front View

SCOUT CAR M3A1

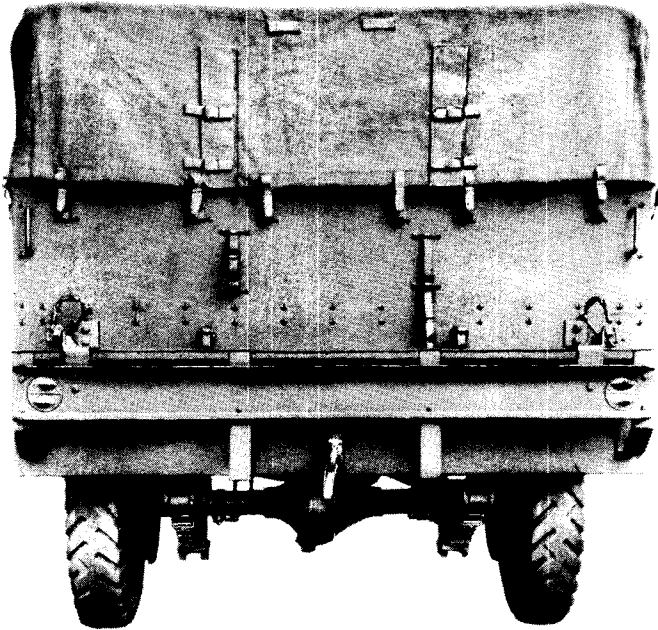

Figure 3 — Rear View

RA PD 13091

	Low	High
Speed (transfer case low and high):		
Reverse	5.05 mph	9.5 mph
First	6.0 mph	11.1 mph
Second	9.5 mph	17.6 mph
Third	17.0 mph	32.3 mph
Fourth	29.5 mph	55.5 mph
Maximum allowable speed.....		45 mph
Transmission capacity		5 qt
Transfer case capacity.....		3½ qt
Front axle capacity.....		3 qt
Rear axle capacity.....		3½ qt
Gasoline tank capacity (2 tanks).....		30 gal
Cooling system capacity (gasoline engine).....		19 qt
Crankcase capacity:		
Gasoline engine-powered vehicles.....		6 qt
Hercules Diesel engine.....		7 qt
Buda Diesel engine.....		9 qt

Chassis number — model and serial numbers are stamped on plate on dash.

Engine number — engine number is stamped on name plate on the right side of engine.

INTRODUCTION

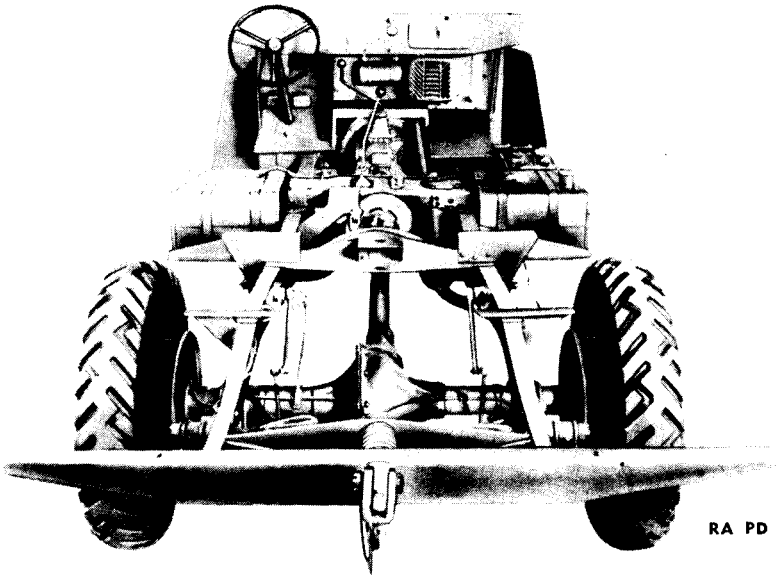

RA PD 3224

Figure 4 — Chassis Plan View

SCOUT CAR M3A1

Section II

DESCRIPTION, OPERATION AND CONTROLS

	Paragraph
Description	3
Controls	4
Starting and warming up the gasoline engine.....	5
Starting and warming up the Diesel engine.....	6
Operating the vehicle	7
Cold weather operation.....	8

3. DESCRIPTION (figs. 1, 2, 3, and 4).

a. **General.** This vehicle consists of a specially designed commercial type, four-wheel drive truck chassis. It is powered by a conventional six cylinder gasoline engine or one of two makes of Diesel engines. The chassis is surmounted by a special armored body mounted on a double-drop type, channel section frame.

b. **Hood.** Top and side protection is afforded the engine by the 1/4-inch armor plate hood which is made of two double panels hinged together to facilitate opening. Two latches on each side secure the hood when closed. A four-blade, 1/4-inch armor plate shutter is provided for radiator protection and is operated manually from the driver's compartment. Stops are provided to hold the shutters open in three intermediate positions between the fully opened and closed positions.

c. **Windshield.** The shatterproof glass windshield, in two sections, is clamped into and flush with the weather stripped frame structure. It is necessary to loosen the clamps and remove the glass sections manually before lowering into place the protective shield of 1/2-inch armor plate, hinged at the top to the windshield supporting frame, and held normally in a raised position by three cowl props. For observation purposes, vision slots are provided in the shield.

d. **Body.** The body is protected by 1/4-inch armor plate at the sides and rear. Each side door is provided with a quadrant to hold the door open at various positions, and a folding armor shield to heighten the armor protection for the driver's compartment. The side shields are hinged to the respective doors and held in an upright position by vertical rods which extend up from and are latched to the doors. Observation openings are provided in the side shields similar to the vision slots in the front shield. Fuel tanks are placed under the seats in the driver's compartment and protected underneath by a steel plate. Vents are provided for conducting fresh air from beneath the hood into the driver's compartment.

DESCRIPTION, OPERATION AND CONTROLS

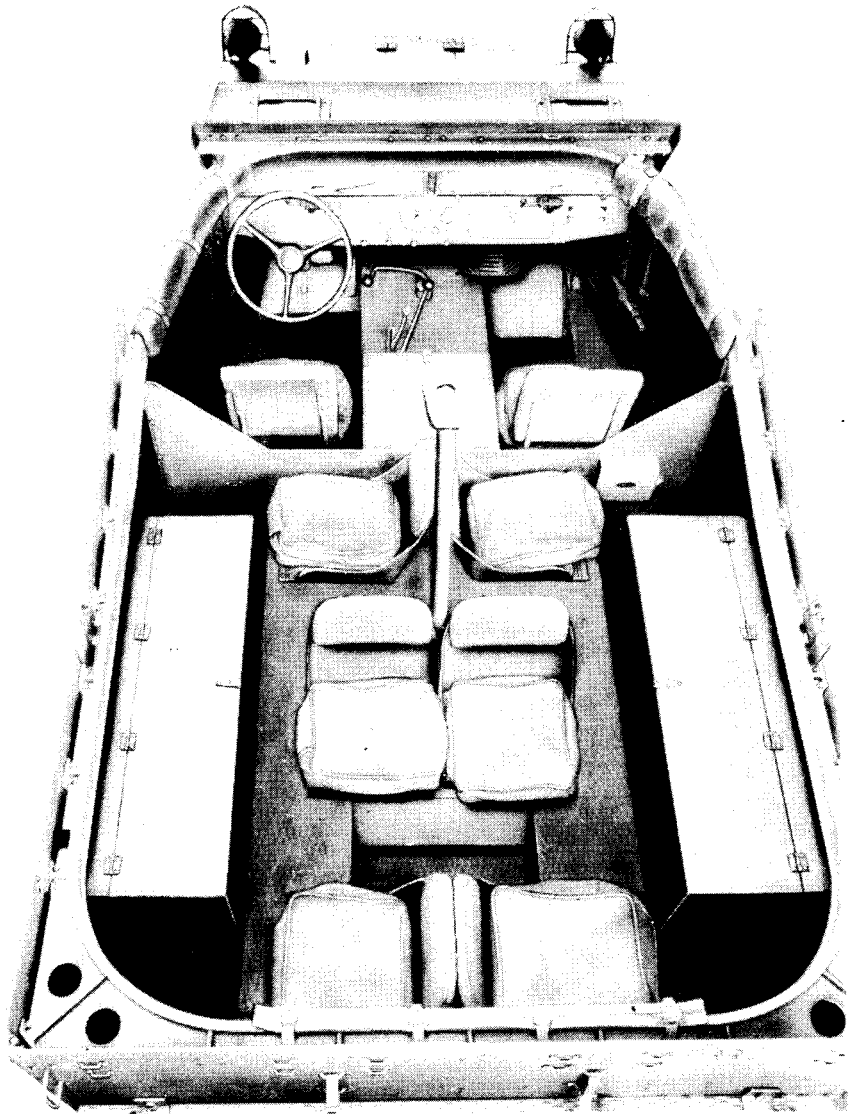

RA PD 3227

Figure 5 — Seating Arrangement

SCOUT CAR M3A1

e. **Seating Accommodations** (fig. 5). A seat is provided in the driver's compartment for the driver at the left, and for the observation commander at the right. Additional seats in the personnel compartment to the rear provide accommodations for six.

f. **Top.** Three removable metal bows connected with web strips, together with the windshield frame, form a support for the detachable, waterproofed duck top. The ends of the bows are set into brackets which are secured inside the body. Integral side and rear curtains, without windows, are secured by zipper fastenings to facilitate opening. They roll and fasten on the inside. The top and its curtains overlap the body and windshield frame and are secured by straps which extend through loops riveted to the plates (fig. 2). Separate curtains and rods are provided for the side doors. The top and side curtains, when not in use, are stowed in the bag provided and are carried inside the vehicle.

(1) A wet top should not be permitted to dry in a lowered or folded position as a top thus dried will usually shrink to such an extent that the fit is seriously impaired. A wet top should be dried while in the raised position, under tension if possible, before being lowered or stored.

(2) It is usually possible to restore a top which has shrunk to the original dimensions by wetting it thoroughly and allowing it to dry while held under tension.

g. **Equipment** (fig. 15). The tourelle gun mount, which encircles the body interior, is provided with a cross-leveling device for firing from that part of the gun rail which is sloped as a ramp, or when the vehicle is not level. Ammunition racks are located over the rear wheel housings at both sides of the vehicle, and another large compartment is provided between the front seats for ammunition or a radio set. Smaller sections for ammunition and water chests are provided to the rear of the front seats, and the tool box is directly behind the right front seat. The radio mast is mounted inside the body. Provision is made for storing the water-bucket and crosscut saw at the rear of the body. Sponge rubber pads are provided for the gun rail at the front seats and along the rear section.

h. **Engines.** Three types of six cylinder engines are used in the Scout Car M3A1. These are a Hercules gasoline engine, Hercules Diesel engine, and a Buda Diesel engine.

4. CONTROLS (fig. 6).

The controls are employed according to the usual automotive practice. The driver must become thoroughly familiar with the location and use of all control devices before attempting to operate the vehicle.

a. **Steering Wheel.** The vehicle is steered by use of the standard type of steering mechanism.

DESCRIPTION, OPERATION AND CONTROLS

b. Clutch and Brake Pedals. The pedals are located on the toe board at the base of the steering column and operated in the conventional manner.

c. Throttle. The throttle is controlled by a foot accelerator pedal, and by a throttle control button on the instrument panel. The foot accelerator pedal is connected to the throttle by mechanical linkage and the hand control button is connected to the throttle by a cable. Hand control is useful for starting but not for driving. The hand control is not affected by pedal operation but the pedal is actuated when the hand control is pulled out.

d. Shift Levers and Hand Brake. The main and auxiliary gearshift levers and the propeller shaft brake lever are located and used in the customary manner. Smooth, firm control is required, without the application of excessive force. The ratios in the transfer case (auxiliary transmission) should not be changed when the vehicle is in motion.

e. Radiator Shutters. The lever for closing or opening the radiator shutters is to the right of the driver's compartment.

f. Ventilators. The right and left ventilators on the toe board in the driver's compartment are controlled by cable-connected buttons mounted on the instrument panel.

g. Windshield Wipers. These devices are controlled by buttons at the base of the respective mechanism. They can be operated only when the engine is running.

h. Instruments, Gages and Switches. The various other aids for operation of the vehicle are described section XXIX.

5. STARTING AND WARMING UP THE GASOLINE ENGINE.

a. General Instructions. Before the engine is started, the prestarting inspection outlined in paragraph 15 must be accomplished. Special care should be taken during the starting and warming-up period to avoid unnecessary engine wear. The procedure outlined below is satisfactory under average operating conditions:

- (1) Set the hand brake securely and place the transmission gearshift lever in neutral position.
- (2) Check fuel supply and position of fuel transfer valve.
- (3) Pull out hand throttle button about $\frac{1}{4}$ inch.
- (4) Depress the clutch pedal to disengage the clutch and ease the starting load.
- (5) Turn the switch and push the starter button.
- (6) Release the starter the moment the engine begins to run.
- (7) After the engine has started, slowly release the clutch pedal and

SCOUT CAR M3A1

RA PD 1848A

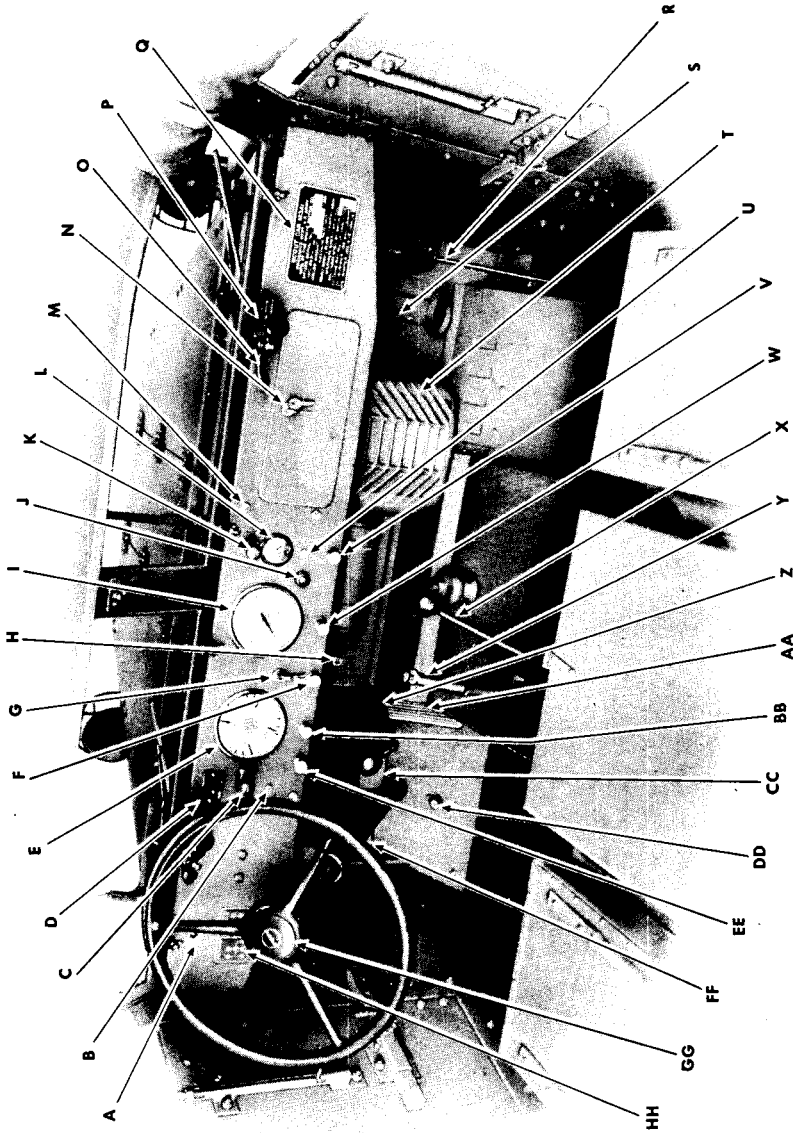

Figure 6 — Driver's Compartment

DESCRIPTION, OPERATION AND CONTROLS

- A. TROUBLE LIGHT RECEPTACLE
- B. STOP LIGHT SWITCH
- C. BLACKOUT AND SERVICE LIGHTS SWITCH
- D. DUAL FUEL TANK SELECTOR SWITCH FOR FUEL GAGE
- E. INSTRUMENT CLUSTER
- F. THROTTLE CONTROL (*FUEL INJECTOR SHUT-OFF)
- G. IGNITION SWITCH (*STARTER CIRCUIT SWITCH)
- H. STARTER MOTOR SWITCH (*VENTURI HEATER CONTROL)
- I. SPEEDOMETER
- J. HEATER SWITCH
- K. DASH LIGHT
- L. VOLTMETER
- M. SCREW
- N. MAP COMPARTMENT DOOR WITH KEY
- O. WINDSHIELD WIPER TUBE
- P. WINDSHIELD WIPER ASSEMBLY
- Q. VEHICLE REGISTRATION PLATE
- R. RADIATOR SHUTTER CONTROL LEVER
- S. FIRE EXTINGUISHER BRACKET
- T. HEATER
- U. VOLTMETER PUSH SWITCH
- V. R. H. VENTILATOR CONTROL
- W. CHOKE (*THROTTLE CONTROL)
- X. TRANSFER CASE SHIFT LEVER
- Y. HAND BRAKE LEVER
- Z. TRANSMISSION GEARSHIFT LEVER
- AA. ACCELERATOR PEDAL
- BB. SPARK (*GOVERNOR CONTROL BUTTON)
- CC. BRAKE PEDAL
- DD. FOOT DIMMER SWITCH
- EE. L. H. VENTILATOR CONTROL
- FF. CLUTCH PEDAL
- GG. HORN BUTTON
- HH. GEARSHIFT INSTRUCTION PLATE

RA PD 13023

*FOR DIESEL ENGINES ONLY

NOTE: STARTER SWITCH LOCATED DIRECTLY BELOW THE STARTER CIRCUIT SWITCH FOR DIESEL ENGINE VEHICLES.

Nomenclature for Figure 6

SCOUT CAR M3A1

adjust the hand throttle to a position that prevents the engine from racing. If the choke was used in starting, push in the choke control as soon as the engine runs smoothly or warms up (approx. 140 F.).

b. Starting Hints. With the battery, fuel system, and ignition system in satisfactory condition, difficulties other than mechanical failures may develop in connection with the starter itself.

(1) The starter should not be engaged for periods longer than 10 to 15 seconds. After the starter has been engaged once, approximately 10 seconds should be permitted to elapse before the starter is engaged again. During this interval the hand should be held lightly on the shift lever, so that engine vibrations may be detected if the engine has been started.

(2) If the starter device engages the engine flywheel and locks, release the starter push button, turn off the switch, place the transmission in high gear, release the brake, and rock the vehicle backward and forward. If the gear still sticks, loosen the starting motor mounting screws and shake the motor until its gear releases. Retighten the bolts and try the starter again.

(3) If the starter does not turn, but the lights dim when the starting button is depressed, the battery may be partially discharged or the starter bearings may be gummed or "frozen." To free gummed bearings, remove the starter (see section XIX) and apply penetrating oil.

(4) If the starter turns when the starter button is pressed and the starter does not engage the engine flywheel, the starter drive may be gummed. To correct, remove the starter (see section XIX) and free the drive by using penetrating oil.

(5) In emergencies, when the engine cannot be started with the starter, it can be started by towing the vehicle. Prior to towing, the engine should be turned over by hand (three revolutions). The towing vehicle should be placed in first (low) gear. The vehicle to be towed should be placed in fourth (high) gear and the transfer case in high range. The engine should be primed or choked and the throttle slightly opened. After the towed vehicle starts moving, the clutch should be engaged smoothly, and when the engine starts turning over, the ignition switch should be turned on. Even though the battery is weak the engine can be started in this manner.

6. STARTING AND WARMING UP THE DIESEL ENGINE.

a. Precautions. The following precautions, if followed, will help eliminate operating difficulties and abnormal wear.

(1) Do not allow oil level to fall much below the 4/4 mark on the bayonet gage. As the lubricating oil is the medium for removing the fric-

DESCRIPTION, OPERATION AND CONTROLS

tion heat in the bearings, the larger the volume the more heat can be absorbed.

(2) Do not run engine at any time without lubricating oil or cooling solution (water or antifreeze mixture).

(3) Do not use oil, fuel oil or kerosene in the cooling solution or as a cooling medium as these will be detrimental to the synthetic rubber water pump seal.

(4) Never run engine with water or antifreeze solution boiling. This allows lubrication to break down and may seriously damage the engine.

(5) Do not put cold water in an overheated engine. It may crack cylinder head, block, etc.

(6) Do not run an engine at high speed without load as this will cause undue wear and shorten the life of the engine.

(7) Do not idle engine for long periods as it is detrimental to the engine.

(8) Do not use engine as a brake in intermediate or low gear in automotive service. Using low or intermediate gear while descending steep grades may increase the engine speed beyond the speed for which it is designed, and damage will result unless vehicle speed is held to that used in same gears on the level.

(9) Never allow engine to run without oil pressure showing on the gage. Damage from lack of lubrication will result.

(10) Do not operate fuel injection pump with one or more lines shut off or blocked, as the high pressure may ruin the pump.

(11) Do not allow fuel in tank to run low, as it may allow fuel transfer pump line to uncover long enough to fill the lines with air and cause the engine to stop, resulting in lost time taken for priming.

(12) Loss of power, erratic running and poor performance often result from air in the fuel injection system. Be sure there are no leaks in fuel lines and filters which will allow this condition to exist. Vent cocks on top of filters are for bleeding off any air which may accumulate from bubbles in the fuel and very minor leaks; therefore it is essential to bleed these often until the operator is sure air is not entering the fuel system.

(13) *Never run starting motor longer than 30 seconds at one time without a rest period of at least 1 minute before allowing it to run again. Failure to follow this procedure may result in a burnt-out starting motor.*

b. Starting Engine After a Long Shut-Down.

(1) See that the engine turns freely by hand; a hand barring device is provided for this purpose. Turn not less than two complete revolutions.

(2) Fill the engine with the required amount of lubricating oil. Check with oil level gage.

SCOUT CAR M3A1

- (3) Fill cooling system with clean water or antifreeze solution.
- (4) Completely lubricate the vehicle.
- (5) Drain all fuel and lubricating oil filters until all water and sediment are removed.
- (6) Fill the battery with clean, distilled water.
- (7) Fill the fuel supply tank with a good grade of fuel oil, using a strainer.
- (8) Open fuel supply valves.
- (9) Open throttle control lever $\frac{1}{3}$ on the quadrant.
- (10) Thoroughly vent the entire fuel system. To assist in filling and venting, most models are equipped with a manual operating lever on the fuel transfer pump. By working the lever, the fuel can be forced through the system to the suction compartment of the injection pump. Vent system as follows:
 - (a) Vent the fuel filter by loosening the vent screw.
 - (b) Vent the fuel suction compartment of the injection pump by loosening the vent plug or connections on the injection pump housing. A small vent plug is provided at the top and on one end of the injection pump housing, and a check valve and overflow line at the other end for venting. Normally the check valve and overflow line will keep the injection pump vented at all times while the engine is running. However, when starting a dry system, it is well to loosen the small vent plug until the fuel flows freely without air bubbles.
 - (c) Vent the fuel lines at the nozzles. Venting the nozzles can be accomplished by loosening the pressure line at the nozzle, allowing the fuel to drain until free from any air bubbles. This draining must be accomplished while the engine is turning over. If the engine is running, this will also prevent the cylinder on which the line is vented from firing. This will aid in locating a weak or missing cylinder.
 - (d) Crank the engine with the starter until fuel flows freely without foaming at each vent, closing each vent opened. NOTE: Air in pump or lines will cause poor operation and hard starting. The air must always be released completely.
- (11) Depress the clutch pedal to ease the starting load. Turn the switch and press the starter button.
- (12) Release the starter button the moment the engine begins to run.
- (13) After the engine has started, slowly release the clutch pedal and adjust the hand throttle to a position that prevents the engine from racing. For temperatures below 50 F, see cold weather operation (par. 8).

DESCRIPTION, OPERATION AND CONTROLS

c. **Usual Routine Method of Starting.** Follow steps (b) (11), (12) and (13) for starting the engine.

7. OPERATING THE VEHICLE.

a. **Starting on Level Ground.** The engine having been thoroughly warmed up and checked for satisfactory operation, the vehicle is placed in motion as follows:

- (1) Release the hand brake.
- (2) Disengage the clutch fully.
- (3) Move the transmission gearshift lever to selected position.

(4) Release the clutch pedal gradually, and at the same time slowly depress the accelerator pedal to increase the speed of the engine, care being taken not to race the engine. **NOTE:** The transfer case shift lever should be in "high" position, unless starting on a hill or in heavy pulling where greater gear reduction is necessary.

(5) **DOUBLE-CLUTCHING.** It may be necessary to double-clutch to assure smooth engagement of the transmission gears. This may be accomplished when shifting from low to high gear ratio or from high to low gear ratio. To double-clutch, disengage clutch and shift transmission into neutral. Hold the transmission gearshift lever in this position and reengage clutch at the same time decreasing (when shifting from lower to higher ranges) or increasing (when shifting from higher to lower ranges) the engine speed to suit engagement in the next gear. Disengage the clutch again and shift transmission lever into the next gear. When properly performed, double-clutching tends to synchronize the mating gears. Double-clutching can be performed quickly and allows better control. When shifting on steep grades, it is necessary to double-clutch.

b. **Starting on a Grade.** If the vehicle is on a grade, one method of starting is as follows:

- (1) Release the hand brake and hold the vehicle with the foot brake.
- (2) Disengage the clutch fully.
- (3) Select low or high speed position to transfer case gearshift, depending upon the steepness of the grade and road conditions.
- (4) Move the gearshift lever to the first speed position.
- (5) Gradually engage the clutch, and at the same time gradually release the foot brake and accelerate the engine by means of the hand throttle.

c. **Gearshifts** (fig. 7). Practice will enable a driver to judge at what rates of speed the vehicle should be moving before he shifts from a lower to a higher speed. An engine should never be permitted to labor unduly when a change in gear ratios would improve operation.

SCOUT CAR M3A1

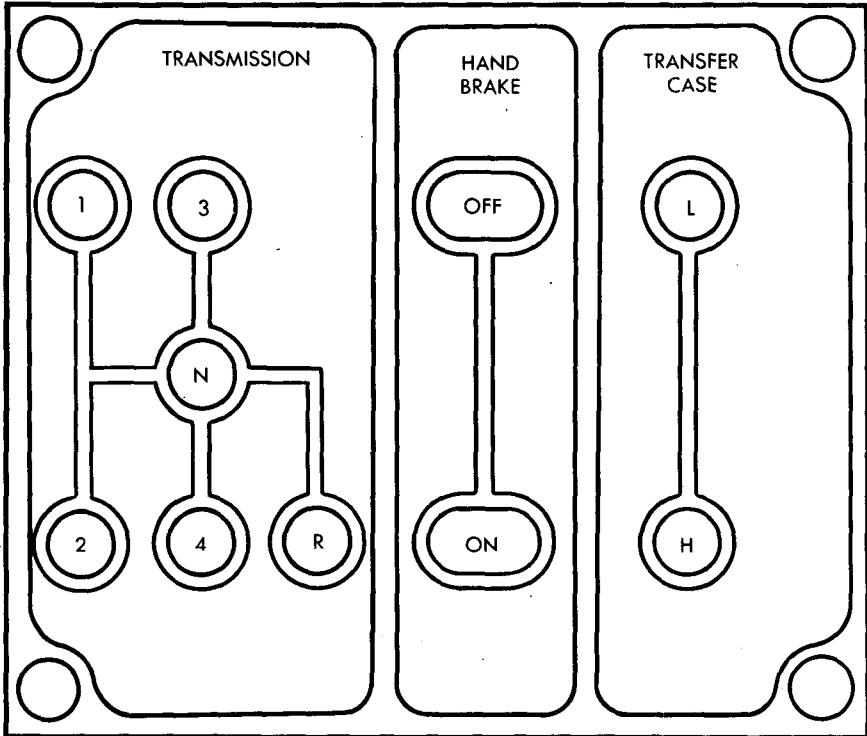

RA PD 13101

Figure 7 — Gearshift Diagram

(1) **TRANSMISSION.** In shifting gears from any speed to a lower speed ratio, disengage the clutch, make the shift to the next lower position, engage the clutch and at the same time depress the accelerator to maintain engine speed.

(2) **TRANSFER CASE.** To shift the auxiliary transmission from high (direct) to low (underdrive) for heavy going, stop the vehicle, disengage the clutch, shift the main transmission into low gear, quickly engage and disengage the clutch while shifting transfer case gears, and then fully engage the clutch to operate the vehicle. Shift the main transmission into higher gears as the situation permits, all regular speed ratios being reduced. When the vehicle is being operated in the underdrive ratio and it is desired to shift back to the direct range, the shift can be made with the vehicle moving at any general speed, due attention being given to the use of the clutch and the speed ratio of the main transmission to prevent shock to the propelling mechanism. However, it is recommended that the vehicle be stopped when shifting transfer case gears to avoid danger of damaging the transmission.

DESCRIPTION, OPERATION AND CONTROLS

(3) **CAUTION:** In shifting from one speed to another, do not skip positions. Do not ride the clutch. The driver's foot should rest on the clutch pedal only when he is operating it. A sudden engagement is injurious to the mechanism and may stall the engine. When the clutch is to be disengaged, it should be disengaged fully to avoid gear damage and shifting difficulties. Every effort should be made to prevent sudden shock to the driving parts in any gear. Guard carefully against dropping the clutch in suddenly at any time, and especially if the vehicle rolls backwards, no matter how slowly. If there is any tendency for the vehicle to roll backward, block the wheels before attempting a start and then engage the clutch and accelerator carefully. If it is not convenient to block the wheels, and should conditions permit, by all means allow the vehicle to coast back to a standstill under control of the brakes before attempting to start forward. *FAILURE TO OBSERVE THESE SIMPLE PRECAUTIONS WILL RESULT IN CERTAIN SNAPPING OF DRIVE GEARS AND SHAFTS.*

d. Braking. The brakes should be in such condition that hard applications will cause all wheels to be locked, but the driver must realize that the maximum retarding effect occurs just before the wheels lock. Intermittent application will reduce the wear of brake linings and drums. Application should be gradual with just enough force to accomplish the desired result.

(1) **USAGE.** In anticipating a stop, the driver should make full use of the engine braking effect, disengaging the clutch in time to avoid stalling the engine. When descending hills, the driver should use the engine as a brake by using the proper gear ratio and applying the brakes from time to time to prevent overspeeding the engine. The ignition should not be turned off. On steep hills, the gear necessary to give the desired results should be engaged before the vehicle is started up or down the hill. Any attempt to shift gears after the vehicle has started down a steep slope may result in a run-away vehicle.

(2) **MOISTURE EFFECT.** After passing through water, the brakes should be set slightly and the vehicle operated for a short period until sufficient heat has been generated to dry the brakes.

(3) **STOPPING THE VEHICLE.** Release throttle, apply foot brake, and shift transmission into neutral before the engine stalls. Do not brake by disengaging and engaging the clutch. When operating at a speed of 20 miles per hour on a dry, smooth, level road free from loose material, the vehicle should be capable of stopping within 30 feet when the foot brake is applied.

e. Traction Aids. Chains should always accompany the vehicle. They should be kept in serviceable condition and in proper adjustment to

SCOUT CAR M3A1

permit installation with a minimum of delay. They should be removed promptly as soon as their use is no longer necessary to prevent damage to tires and roads. The chains should be installed before the vehicle becomes mired, and in such a manner that rotation of the wheel tends to close the chain fastenings. If the chains are improperly installed, rotation of the wheels opens the fastenings and the chains will be lost. Fairly loose adjustment gives better traction and less tire wear than tight adjustment.

8. COLD WEATHER OPERATION.**a. Gasoline Engine Vehicles—Temperatures from -10 F to -30 F.**

(1) It is possible to start gasoline engines with batteries at temperatures as low as -30 F if the engines are properly lubricated and in good mechanical condition. First "break" engine free with hand crank. Every effort should be made to avoid having the engine fire a few times and then stop.

(2) Prior to attempting a start, care should be taken that everything is in readiness so that the engine will start on the first trial. Water is one of the products of gasoline combustion. In a cold engine, this water may form a frost and make it impossible to start without heating the engine to above 32 F. Prolonged efforts to start will wear down the battery.

(3) Pull the choke lever all the way out for starting and keep it partially pulled out until the engine has warmed up. In a cold engine, only the lightest components of the gasoline vaporize, and for this reason a very rich mixture is necessary.

(4) When attempting a start, turn the engine over as rapidly as possible. All engines have a "critical cranking speed," that is, the engine must be turned over at a certain rate of speed before any start at all is possible. For engines in good mechanical condition, this critical rate of speed may vary from 40 to 70 revolutions per minute. Below this speed, the fuel pump will not deliver fuel fast enough to keep the engine running.

(5) After the engine is started, idle it until it has warmed up sufficiently to run smoothly. Idle engine at a low speed.

b. Gasoline Engine Vehicles—Temperatures Below -30 F.

(1) Cover engine with the tarpaulin, tent, or portable shed. Place oil stove, fire pots, or four or five ordinary kerosene lanterns under the covering about 3 hours prior to the time a start is to be made.

(2) Keep the vehicles in sheltered areas shielded from wind. Cold winds increase starting difficulties.

(3) It is possible for ice to collect in the fuel line. If the engine does

DESCRIPTION, OPERATION AND CONTROLS

not appear to be getting enough fuel, lightly heat the fuel line, *but be very cautious of fires.*

c. **Stopping Gasoline Engine.** Before turning off the ignition, increase engine speed, then turn off the ignition and release the throttle at the same time. As the engine coasts to a stop, it will blow out all the residual products of combustion, which include water vapor, and leave only air and gasoline vapor in the engine.

d. **Diesel Engine Vehicles.** The increased temperature of the air due to compression is the only means of igniting the fuel sprayed into the combustion chamber. If the iron surrounding this chamber is extremely cold, and in addition the air entering the cylinder before compression is cold, the resultant temperature may not be sufficient to ignite the mist of fuel. Two methods are available to increase this temperature:

(1) **HEATING THE AIR BEFORE IT REACHES THE CYLINDER.** Mounted in the Venturi of the air intake system is a heater element which can be used to heat the air entering the combustion chamber in cold weather. Pressing the heater button on the toe board sends current through a heater element. Air passes over the heater element and is warmed before entering the cylinder. Length of time will vary with temperature conditions, usually from $\frac{1}{2}$ to 1 minute. Remove foot and start engine in the regular manner. **CAUTION:** Do not depress starter button while heater button is depressed. The heater should be used only when necessary.

(2) **HEATING THE WATER OR COOLING SOLUTION.** As an aid in cold weather starting, the cooling solution should be drained into a drum or suitable vessel and heated. (Caution should be taken against fire if alcohol solution is used.) When this heated solution is poured into engine, the cold iron parts are heated and the oil on cylinders is thinned down.

(3) At temperatures below 0 F, the heating of water, oil and air may be desirable. Battery output is reduced at these low temperatures so every means should be used to conserve the battery. At these temperatures it is advisable to drain the oil at the end of the day's run and thoroughly heat and return to engine just before starting. Drain the water and sediment from the filter housings frequently, as water collects quickly due to condensation.

SCOUT CAR M3A1

Section III

ARMAMENT

	Paragraph
Weapons and mounts	9
Tripod mount M1917A1	10
Tripod mount M3	11
Carriage	12
Cradle mount M30	13

9. WEAPONS AND MOUNTS.

Characteristic armament for the vehicle is tabulated below:

Weapons per Vehicle	Weapons	Mounts per Vehicle	Mounts
1	Gun, machine, Browning, cal. .30, M1917A1	1	Mount, tripod, cal. .30, M1917A1
1	Gun, machine, Browning, cal. .50, M2, HB, flexible	1	Mount, tripod, cal. .50, M3
		1	Mount, gun, cal. .50, M30

10. TRIPOD MOUNT M1917A1 (fig. 8).

The tripod mount is a variable height, folding tripod, with tubular legs and a cradle to mount the Browning machine gun, cal. .30, M1917A1. The cradle is designed so that the gun is mounted in the approximate line of recoil to increase stability. The cradle permits elevation to provide both for ground and antiaircraft fire.

11. TRIPOD MOUNT M3 (fig. 9).

This mount is a variable height folding tripod with telescoping legs. Normal mounting of the tripod is with the front leg set at an angle of 60 degrees and all extensions projected and secured. In this position on level ground, the center of the gun trunnion is at a height of 10 inches, and the mount is stable. If this height is increased, the gun recoil destroys stability and makes mandatory the extension of the rear legs if stability is to be retained. No cradle is provided. Antiaircraft fire is not possible with this mount.

12. CARRIAGE (fig. 10).

This rolling carriage is used for both the cal. .30 and the cal. .50 machine gun mounts. It provides for travel on the continuous track

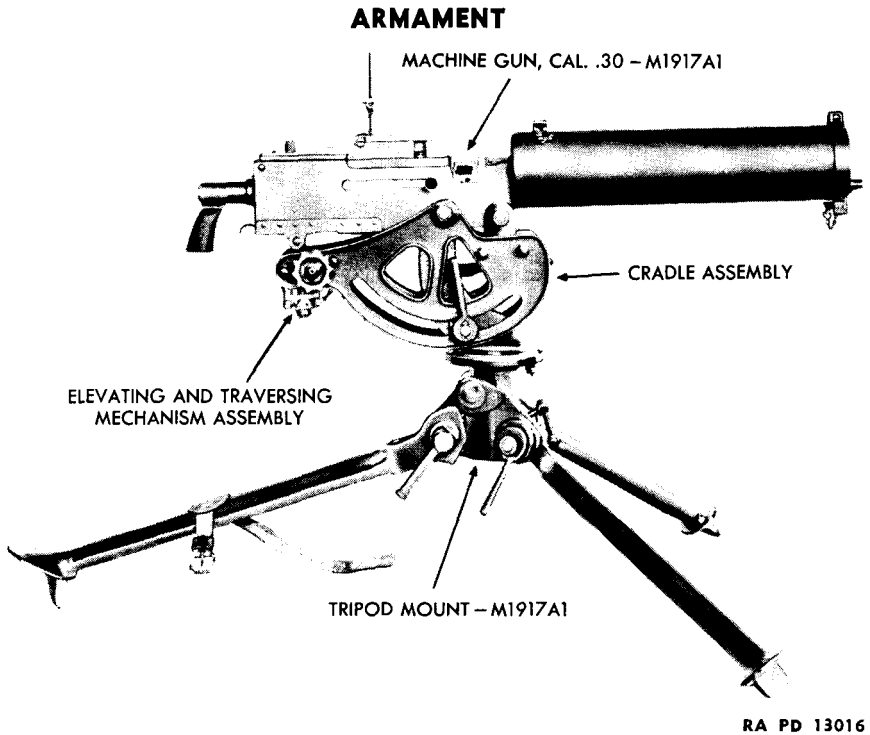

Figure 8 — Browning Machine Gun, Cal. .30, M1917A1 on Tripod Mount, M1917A1

which extends around the inner side of the vehicle. It can be locked for firing at any position of the track and canted for any position of the vehicle. The usual elevating mechanisms provided with the guns are employed for accurate adjustment. An anticanting device for the pintle compensates for the displacement of the track from a horizontal plane.

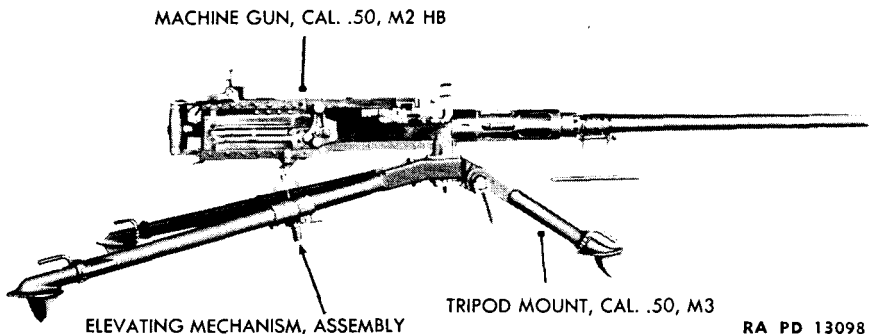

Figure 9 — Browning Machine Gun, Cal. .50, M2 on Tripod Mount

SCOUT CAR M3A1

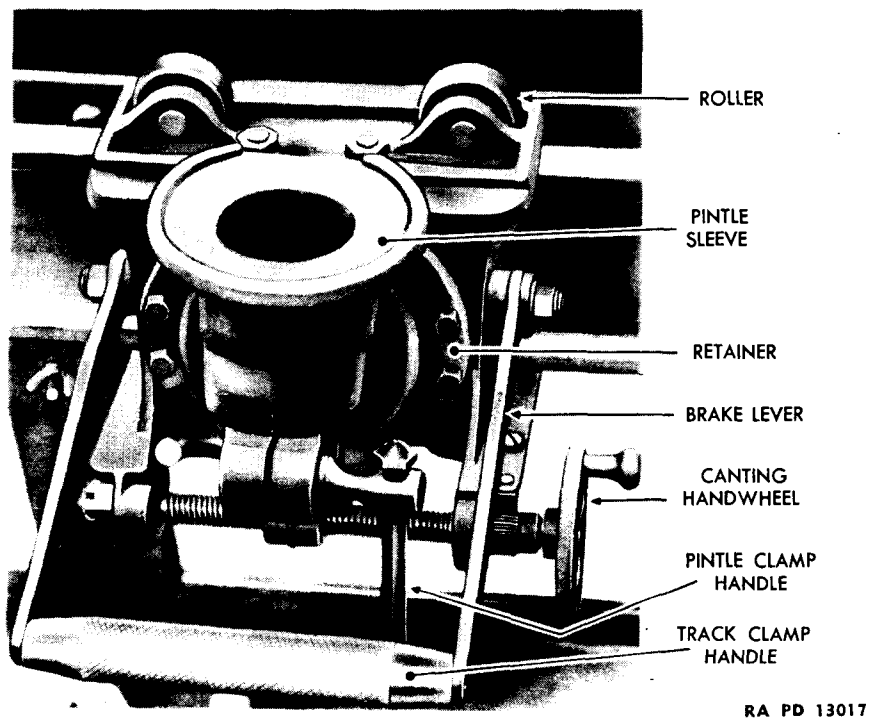

Figure 10 — Carriage, Machine Gun Mount, M30

a. **Description** (figs. 10 and 11). The carriage is composed of a body and pintle sleeve assembly.

(1) **BODY.** The body of the machine gun carriage has two top rollers, two bottom rollers, four outer rollers, and four inner rollers. It is locked to the track by means of levers which are assembled to right-hand and left-hand cam screws which, in turn, mount the holding clamps. The cam screws are supported by the frame sides and a bearing in the center of the frame. The levers are assembled to the screws on separate bearings to permit adjustment of the lever position for clamp wear compensation and are held in place by washers and nuts. Springs are provided to retain the levers in a locked position to prevent accidental moving of the carriage on the track. The clamps are wedge-shaped; and as the levers are released, the clamps are forced outward to wedge the four inner rollers against the track. To unlock the carriage, raise the track clamp handle.

(2) **PINTLE SLEEVE.** The pintle sleeve fits over a bushing which is part of the body casting. It rotates about this bushing and is held in place by two retainers which are bolted to the frame. The lower end of the pintle sleeve is split, and $\frac{1}{2}$ is threaded for a bolt which pulls

ARMAMENT

the split together and locks the pintle in any position desired. The split end also has a latch passing through it to hold the cradle pintle in the sleeve. A sector is bolted to the bottom of the sleeve, and into this is set a sector nut which is threaded onto a carriage screw. One end of the screw has the handwheel pinned to it, and the other end is secured by a nut. Turning this handwheel rotates the screw and makes the center sector nut travel back and forth, causing the sector and pintle sleeve to cant or tilt to the right or left and compensate for the side slope of the track as the vehicle moves about. By turning the control wheel clockwise, the vertical center line of the gun mount will be displaced to the left, and vice versa. The pintle clamp, which prevents the pintle from revolving, is independent of the anticanting control.

b. Replacement (fig. 11).

(1) REMOVAL.

Wrench, open-end, $\frac{3}{4}$ -in.

Remove four nuts, washers and bolts from the outer rollers and slide the carriage over the track.

(2) INSTALLATION.

Wrench, open-end, $\frac{3}{4}$ -in.

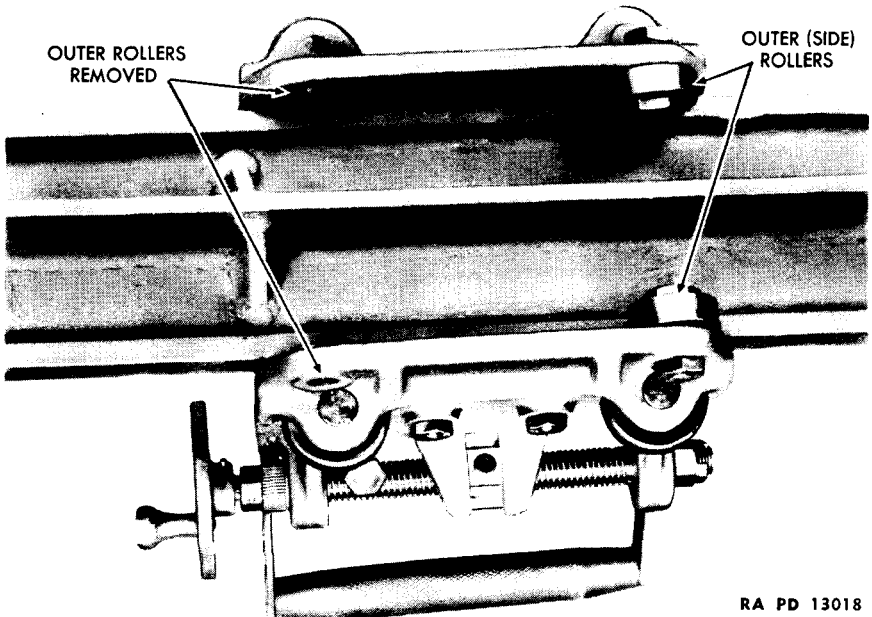

RA PD 13018

Figure 11 — Machine Gun Carriage Installation

SCOUT CAR M3A1

Place carriage on the track and place the roller and washer on the bolt, insert in position on the carriage and tighten the nut.

c. **Lubrication.** Excessive wear can be prevented by keeping the materiel clean and well lubricated. OIL, lubricating, preservative, light, should be used. The trunnion bearings, clamping devices, elevating screw, carriage rollers and other bearings subject to wear should be lubricated daily and before each period of firing. The track should be wiped with an oily rag to protect it against rust.

13. CRADLE MOUNT M30 (fig. 12).

This mount is designed for the Browning machine gun, cal. .50, M2, heavy barrel, and permits all-around ground fire from inside the vehicle.

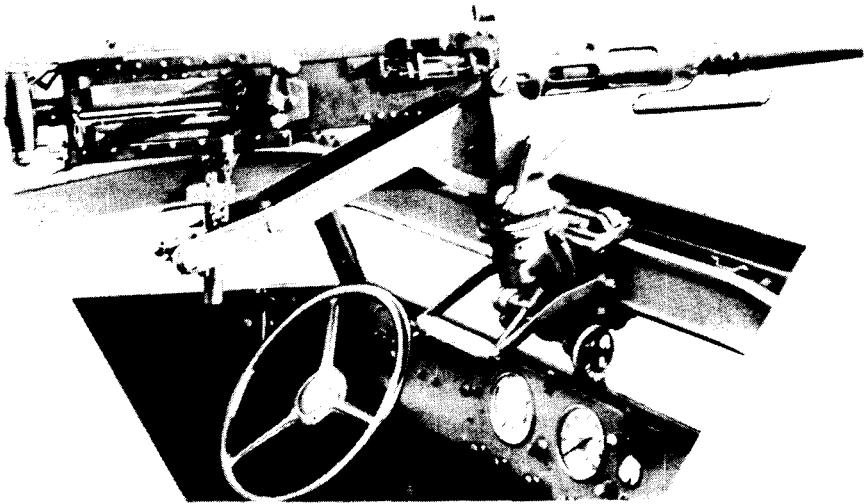

RA PD 13020

Figure 12 — Cradle Mount, Cal. .50 - Installed

a. **Dismounting Gun.** For ground fire from the tripod, remove the machine gun from the cradle of the mount by releasing the gun pintle, disconnecting the elevating mechanism *at the cradle*, and lifting weapon with gun pintle attached.

b. **Dismounting Cradle.** Dismount the cradle, or the gun and cradle, with the *cradle* pintle attached, by releasing the carriage pintle clamp, withdrawing pintle latch, and lifting the mount from the carriage sleeve.

c. **Lubrication.** Refer to paragraph 12, c.

Section IV

INSPECTION

	Paragraph
Purpose	14
Prestarting inspection	15
Inspection during operation	16
Inspection at the halt	17
Inspection after operation	18
Periodic inspection	19

14. PURPOSE.

a. To insure mechanical efficiency, it is necessary that vehicles be systematically inspected at intervals in order that defects may be discovered and corrected before they result in serious damage.

b. Cracks that develop in castings or other metal parts may often be detected upon the completion of a run by the presence of dust and oil deposits.

c. The Chief of Ordnance should be advised through the local ordnance officer of any chronic troubles, technical failures or unsatisfactory operation of any part or unit. Failures within the guarantee period (1 year or 4,000 miles) will be reported promptly. Any suggestions for the improvement of the inspection procedure based on actual operating experience should likewise be forwarded so that all units may benefit. The report will contain the following:

(1) Identity of vehicle and component assembly. The ordnance designation of vehicle and component, including the U. S. registration number, the ordnance serial number, the name of the manufacturer and the manufacturer's designation including the model, type and serial number, the length of service in miles or hours and date on which the defective component or assembly was installed in the vehicle.

(2) Description of failure, defects or improper functioning. The name of the place and date of failure, the manner in which the component is damaged, defective or improperly functioning, setting forth the attending circumstances and known causes of the failure, defect or improper functioning together with pertinent drawings, photographs, sketches and sample specimens.

(3) Remedy or action taken, the present location of the replaced or defective part, the source of the part used in making the repairs or replacement, the source of labor used in making the repairs or replacement if other than ordnance personnel.

(4) A separate report will be made for each failure unless there are a number of identical failures to be reported. In that event the

SCOUT CAR M3A1

single report may be submitted, provided each vehicle involved is identical. The local ordnance officer will forward reports to Office, Chief of Ordnance. These reports should not be addressed to an arsenal, manufacturer, or contractor unless such action is specifically authorized.

(5) Defective or broken material that has been replaced and reported by this procedure must be held pending disposal instructions from the Office, Chief of Ordnance.

15. PRESTARTING INSPECTION.

a. Check fuel supply and position of fuel transfer valve, oil in crankcase, water and antifreeze in radiator, and battery water. **NOTE:** Never fill the fuel tank while the engine is running, or near an open flame.

b. Examine surface under vehicle for evidence of leaks.

c. Check engine for loose parts and electrical connections, and check fuel and lubricating oil lines for leaks.

d. Inspect tires for inflation and for casing injuries.

e. Inspect front axle and steering linkage.

f. Check lights and horn.

g. Check tools and equipment.

h. Check fan belt tension and adjust if required.

16. INSPECTION DURING OPERATION.

a. During operation, the driver should be alert to detect abnormal functioning of the engine. He should be trained to detect unusual engine sounds or noises. He should glance frequently at the instrument panel gages to see if the engine is functioning properly.

b. Only under exceptional circumstances should a vehicle be operated after indications of trouble have been observed. When in doubt, the engine should be stopped and assistance obtained. Inspection during operation applies to the entire vehicle and should be emphasized throughout the driving instruction period.

17. INSPECTION AT THE HALT.

a. At each halt the operator should make careful inspection of the vehicle to determine its general mechanical condition. Minor defects detected during the march, together with defects discovered at the halt, should be corrected during the halt; and proper disposition of the vehicle should be made so that unnecessary delay may be avoided and major failure prevented.

b. A suitable general routine is as follows:

(1) Allow the engine to run a short time and listen for unusual noises. If unusual sounds or knocks are heard with the engine running,

INSPECTION

while the vehicle is stopped and the clutch disengaged, the trouble is probably in the engine assembly.

(2) Look over the vehicle for fuel, oil, and water leaks. Check fuel, lubricating oil (after engine is stopped a few minutes), and water supply.

(3) Inspect tires for correct inflation, cuts, imbedded objects and misalignment.

(4) Feel brake bands, hubs, and gear cases for evidence of overheating.

18. INSPECTION AFTER OPERATION.

a. At the conclusion of the day's operation, an inspection should be made similar to that made at halts but more thorough and detailed

The inspection should be followed by preventive maintenance. If defects cannot be corrected, they should be reported promptly to the chief of section or other designated individual.

b. The following points should be covered:

(1) Raise the hood and look for loose, missing, or broken parts, and indications of improper operation.

(2) Examine grease seals for evidence of failure or overlubrication.

(3) Check axles, springs and shackles for condition and attachment.

(4) Examine propeller shafts and brake linkage.

(5) Check body bolts; tighten or replace, as required.

(6) Check tools and equipment; secure replacements, if necessary.

(7) Check armament and ammunition.

19. PERIODIC INSPECTION.

a. **1,000 Mile Periodic Inspection.** In addition to the daily checks, every vehicle should be thoroughly inspected after every 1,000 miles of operation. Any vehicle properly inspected at this interval should not develop any mechanical trouble for at least another 1,000 miles, unless various driving condition cause strain or breakage of material. The following checks and inspections should be made at this period:

(1) Lubricate vehicle. Follow lubrication guide (fig. 13).

(2) Service and parking brake lining.

(3) Service and parking brake shoe clearance.

(4) Fluid level in master cylinder.

(5) Brake rods, clevis pins, and cotter pins.

SCOUT CAR M3A1

- (9) Brake lines and connections.
- (10) Propeller shaft, for wear and bolts being loose.
- (11) Clutch adjustment, slipping and grabbing.
- (12) Rear and front differential for leaking oil.
- (13) Play in front and rear differential.
- (14) Transmission and transfer case mountings, for breaks and for leaking oil.
- (15) Front and rear springs for breaks.
- (16) Loose spring U-bolt nuts.
- (17) Spring shackles for wear and breaks.
- (18) Loose and improperly adjusted wheel bearings.
- (19) Drag link adjustment.
- (20) Steering adjustment.
- (21) Steering arms for cracks.
- (22) Front and rear axle flange, tighten loose nuts, replace leaking gaskets.
- (23) Radiator mountings, tighten.
- (24) Hood.
- (25) Fan belts for wear and adjustments.
- (26) Fan bracket, tighten, check for cracks.
- (27) Condition of water hoses, tighten hose connections.
- (28) Exhaust system, check for leaks, loose mountings.
- (29) Engine mountings.
- (30) Spark plugs, clean and regap.
- (31) Valve clearances.
- (32) Cylinder head, tighten, if necessary.
- (33) Water pump and pump packing.
- (34) Oil filter, change, if necessary.
- (35) Starter and generator brushes and commutator.
- (36) Oil pressure.
- (37) Oil filter cap, clean.
- (38) Wires, connections, and shielding.
- (39) Air cleaner, remove, clean and change oil.
- (40) Sediment bowl, drain and clean filter element.
- (41) Screen at carburetor, clean.
- (42) Fuel lines, check for leaks and kinks.

INSPECTION

(43) Fuel pump, clean sediment bowl and screen at pump, check pump with tester.

(44) Carburetor control rods, tighten.

(45) Distributor, clean and check breaker point clearance, check rotor, distributor cap and high tension wires.

(46) Generator output.

(47) Battery condition, mountings and connections.

(48) Ground connections, clean and tighten.

(49) Gages, replace broken units.

(50) Windshield wipers, replace faulty units and poor blades.

(51) Heater, check switch, motors, and connections.

(52) Defroster.

(53) Mirror, tighten, replace broken or discolored ones.

(54) Seats, tighten.

(55) Bumper, tighten, straighten.

(56) Roller.

(57) Pintle.

(58) Head lamps, tighten, clean reflectors, focus.

(59) Tires, check for uneven wear, valve caps, breaks.

(60) Wheels, tighten.

(61) Fire extinguisher.

(62) Door locks, handles and hinges.

b. Additional Inspection List for Diesel Engines.

(1) Fuel filters, remove and clean fuel filter elements, one on dash and one under vehicle beneath driver's seat.

(2) Lubricating oil filter, drain, remove element and clean.

(3) Fuel injection pump, tighten coupling and support, clean check valve.

(4) Vacuum pump oil reservoir, drain oil and refill to proper level.

(5) Fuel injection pump drive chain, adjust slack.

(6) Thermostat operation.

(7) Oil screen at bottom of oil pan, remove and clean.

(8) Check fuel nozzle pressure.

(9) Drain and refill fuel injection pump with light machine oil.

SCOUT CAR M3A1

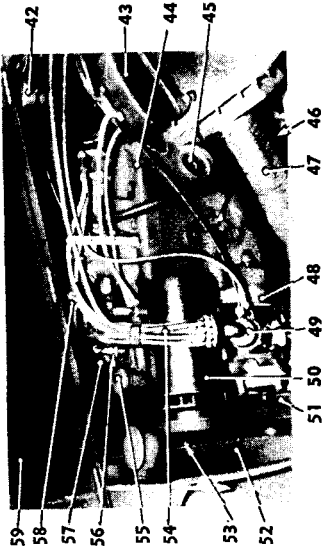

RA PD 51135

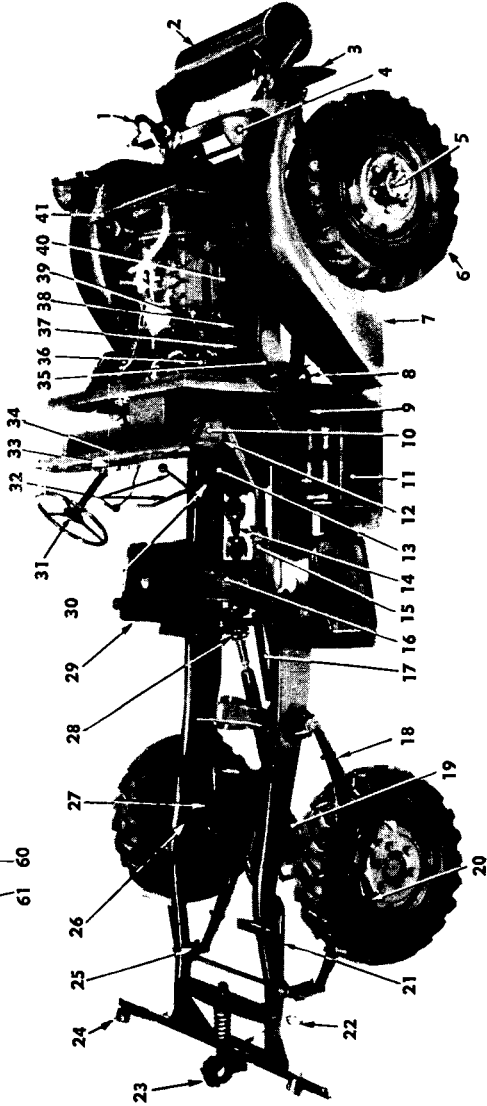
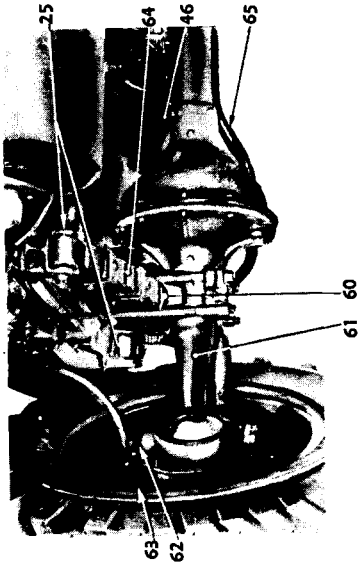

Preventive Maintenance Chart (1000 miles)

INSPECTION

ASSEMBLY	OPERATION		PAR. NO.	UNIT OR ASSEMBLY	OPERATION		PAR. NO.
	CK	TN			CK	TN	
	CK	TN	34	INSTRUMENT PANEL	CK	TN	
	CK	TN	35	OIL PAN	CK	TN	139
	CK	TN	36	AIR CLEANERS	CK	CL	186
	CK	CL	37	STARTING MOTOR	CK	TN	100
PS (NOTE 1)	CK	ADJ	229	FUEL PUMP	CK	TN	183
	CK	RPL	228	CARBURETOR, FUEL LINES AND CONTROLS	CK	TN	185
	CK	TN	38	VALVES AND VALVE SPRINGS	CK	ADJ	141, 142
	CK	TN	39	RADIATOR (NOTE 3)	CK	CL	77
MINIMALS	CK	CL	99	OIL FILTER	RPL		24
	CK	CL	114	GENERATOR REGULATOR	CK	TN	102
	CK	CL	99	CYLINDER HEAD	CK	TN	136
	CK	ADJ	73, 74	VACUUM BOOSTER AIR CLEANER	CK	CL	64
	CK	TN	222	VACUUM BOOSTER (NOT SHOWN IN ILLUSTRATION)	CK	CL	64
	CK	TN	207	VENTILATOR TUBE	CK	TN	79
	CK	TN	175	WATER PUMP (NOTE 4)	CK	TN	104
	CK	TN	219	DISTRIBUTOR ASSEMBLY	CK	CL	ADJ
	CK	TN	175	GENERATOR	CK	TN	101
	CK	TN	211	ENGINE SUPPORT	CK	TN	
	CK	TN	52	RADIATOR SHROUD	CK	TN	
	CK	ADJ	65	FAN ASSEMBLY AND BELTS	CK	TN	78
	CK	TN	175	RADIO SHIELDING	CK	CL	106
	CK	CL	106	OIL FILLER CAP	CL		
	CK	TN	56	SPARK PLUGS	CK	CL	105
	CK	CL	113	MANIFOLDS	CK	TN	138
NS	CK	TN	211	HOSES AND CONNECTIONS	CK	TN	80
	CK	TN	213	HOOD	CK	TN	
	CK	TN	67	SPRING U-BOLTS	CK	TN	211
	CK	TN	69	FRONT AXLE ASSEMBLY (NOTE 5)	CK	TN	50
	CK	CL	187	STEERING KNUCKLES	CK	TN	50
(NOT SHOWN IN ILLUSTRATION)	CK	TN	63	WHEELS	CK	TN	228
	CK	TN	216	64 SPRINGS	CK	TN	211
	CK	TN	65	TIE ROD	CK	TN	50
HES	CK	TN	110, 203				

SHOULD BE SHORTENED IF SEVERE OPERATING CONDITIONS PREVAIL. UNITS OR ASSEMBLIES TO BE REPLACED
 UTILITY AND WILL NOT OPERATE SATISFACTORILY AFTER BEING CHECKED, CLEANED, TIGHTENED, OR ADJUSTED.
 SHOULD BE THOROUGHLY CLEANED AND CHECKED WHEN REPLACING BRAKE SHOES.
 CHECKED THROUGH INSPECTION HOLES IN BRAKE DRUMS.
 CHECKED WHEN LUBRICATED AND LUBRICATED AFTER EACH OPERATION.
 CHECKED WHEN LITTLE OR NO ADJUSTMENT IS LEFT ON PACKING HOLES.
 WHEELS.

KEY
 ADJ — ADJUST CK — CLEAN
 CK — CHECK CL — CHECK RPL — REPLACE
 TN — TIGHTEN RPL — REPLACE
 TN — TIGHTEN

Notes for Preventive Maintenance Chart (1000 miles)

RA PD 51135B

SCOUT CAR M3A1

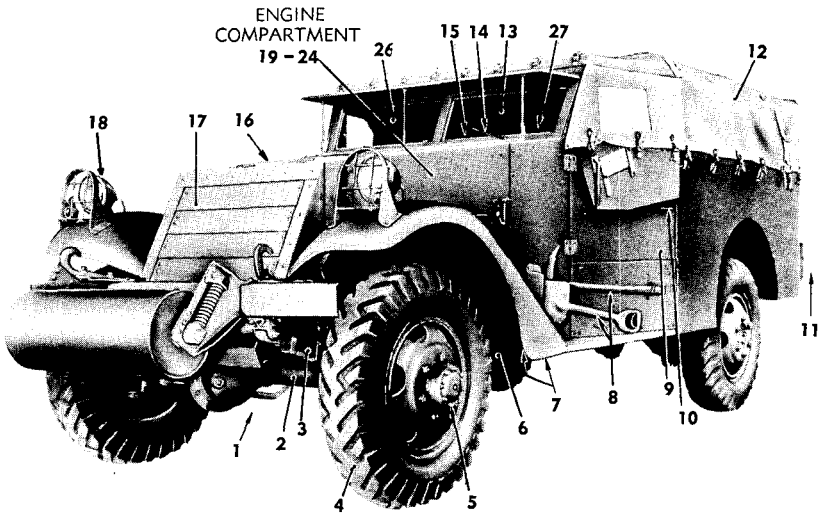

NO.	UNIT OR ASSEMBLY	INTERVALS		OPERATION				PAR. NO.
1	EVIDENCE OF LEAKS ON GROUND	PS		CK				
2	FRONT AXLES AND STEERING LINKAGE	PS	AO	CK	TN	ADJ	RPL	50
3	SPRINGS (FRONT AND REAR)	PS	AO	CK	TN		RPL	211
4	TIRES	PS	AO	CK	INF	REP	RPL	228
5	WHEEL NUTS	PS	AO	CK	TN			228
6	PROPELLER SHAFTS	PS	AO	CK	TN		RPL	207
7	BRAKE LINKAGES	PS	AO	CK	ADJ		RPL	67
8	TOOLS AND ACCESSORIES	PS	AO	CK	TN		RPL	34-35
9	FUEL SUPPLY (2 TANKS)	PS	AO	CK				
10	DOOR HANDLES, HINGES AND BODY BOLTS	PS	AO	CK	TN		RPL	
11	TAIL LIGHT	PS	AO	CK	TN		RPL	113
12	TOP (CANVAS COVER)	PS	AO	CK				
13	WINDSHIELD	PS	AO	CK	CL	TN	RPL	
14	WINDSHIELD WIPERS	PS	AO	CK	RPL			
15	INSTRUMENTS AND SWITCHES (NOT SHOWN)	PS	DO	CK	RPL			203-204-205-210
16	BATTERY (NOT SHOWN IN ILLUSTRATION)	PS		CK				99
17	LOUVERS	PS	AO	CK				
18	HEAD LIGHTS	PS	AO	CK	CL	TN		112
19	OIL IN CRANKCASE	PS	AO	CK				
20	WATER OR ANTI-FREEZE IN RADIATOR	PS	AO	CK				77
21	LOOSE, MISSING OR BROKEN PARTS	PS	AO	CK	TN		RPL	
22	ELECTRICAL CONNECTIONS	PS	AO	CK	TN			
23	FAN BELTS	PS	AO	CK	TN		RPL	78
24	ENGINE NOISES	DO		CK				133
25	BRAKE AND CLUTCH TRAVEL	PS	DO	AO	CK	ADJ		67-72
26	ARMAMENT AND AMMUNITION	PS		CK	RPL			9-13
27	HORN	PS	DO	AO	CK	RPL		115

NOTE: SEE PARAGRAPHS 20 TO 25 FOR LUBRICATING INTERVALS

OPERATIONS		INTERVALS	
AD — ADJUST	INF — INFLATE	PS — PRESTARTING	
CK — CHECK	RPL — REPLACE	DO — DURING OPERATION	
CL — CLEAN	TN — TIGHTEN	AO — AFTER OPERATION	

RA PD 51136

Preventive Maintenance Chart (Prestarting, during operation and after operation)

Section V

LUBRICATION

	Paragraph
Introduction	20
Schedules	21
Lubrication instructions for Diesel engines	22
Methods	23
Engine lubricating system	24
Detailed lubrication and service instructions	25

20. INTRODUCTION.

Lubrication is an essential part of preventive maintenance, determining to a great extent the serviceability of parts and assemblies. Lubrication, or the lack of it, materially influences repairs and operations, and is one of the most important factors effecting dependable service and useful vehicle life.

21. SCHEDULES.

a. In general, the chassis and slow-motion parts should be lubricated every 1,000 miles of vehicle operation. The crankcase oil should be checked daily and changed after not more than 1,000 miles of operation. The oil should be changed more often during prolonged periods of cross country driving, hard pulls, or idling. Gear lubricants should be checked weekly, and changed seasonally, unless operating mileages require more frequent changes. Severe operating conditions may necessitate immediate change, especially in cases where vehicle components have been submerged in water, chemicals, snow or mud. All breathers in housings and gear cases should be examined frequently to see that they are clean and free. Refer to lubrication guide (fig. 13) for schedule of lubrication.

b. **Records.** A complete record of lubrication will be kept for each vehicle. Responsible personnel will execute a check sheet at regular intervals to indicate the actual mileage and date at which each component receives such attention as prescribed.

22. LUBRICATION INSTRUCTIONS FOR DIESEL ENGINES.

The following instructions cover the various points to be lubricated at regular intervals, these being arranged on a mileage basis. Continue lubrication at multiples of all mileages given. See that grease is actually oozing from the parts. **NOTE:** Check level of engine oil daily, and maintain the level marked on the gage.

a. Buda Diesel.

1,000 miles — oil.

Starter motor — 8-10 drops engine oil in each well.

SCOUT CAR M3A1

ORDNANCE DEPT. STARTING SERIAL No.—131. Located on plate on instrument panel.

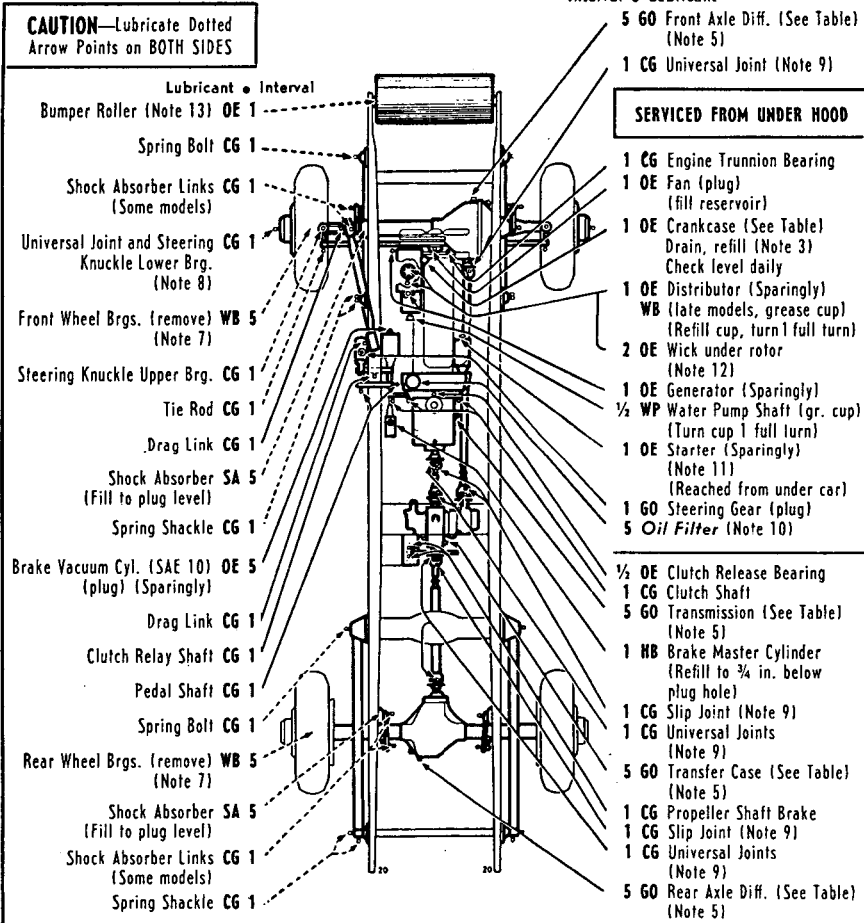

KEY

LUBRICANTS

- OE—OIL, Engine Crankcase grade
- CG—LUBRICANT, Gear, Universal
- CG—GREASE, General Purpose No. 1 (above +32°) No. 1 or No. 0 (+32° to ±10°) No. 0 (below +10°)
- WB—GREASE, General Purpose No. 2
- WP—GREASE, Water pump
- PO—OIL, Penetrating
- SA—SHOCK ABSORBER FLUID (Note 6)
- HB—FLUID, Brake, Hydraulic

INTERVALS

- ½— 500 MILES
- 1—1,000 MILES
- 2—2,000 MILES
- 5—5,000 MILES

CHECK DAILY

Crankcase and Air Cleaners

Figure 13 — Lubrication Guide

LUBRICATION

ORDNANCE DEPT. STARTING SERIAL No.—131. Located on plate on instrument panel.
NOTES Additional Lubrication and Service Instructions on Individual Units and Parts **NOTES**
COLD WEATHER: For Lubrication and Service below -10° , refer to OFSB 6-11.

TABLE OF CAPACITIES WITH RECOMMENDATIONS AT TEMPERATURES SHOWN

	Capacity	Above $+32^{\circ}$	$+32^{\circ}$ to $+10^{\circ}$	$+10^{\circ}$ to -10°	Below -10°
Crankcase	6 qt.	OE SAE 30	OE SAE 30 or 10	OE SAE 10	Refer to OFSB 6-11
Transmission	5 qt.	GO SAE 90	GO SAE 90 or 80	GO SAE 80	
Differential (front)	3 qt.				
Differential (rear)	3½ qt.				
Transfer Case	3 ½ qt.				

1. **FITTINGS**—Clean before applying lubricant. Lubricate until new grease is forced from the bearing. **CAUTION:** Lubricate chassis points after washing vehicle.
2. **AIR CLEANERS**—(Engine) Check level and refill oil cup to bead level daily with used crankcase oil or with OE. Drain, clean and refill every 100 to 1,000 miles, depending on operating conditions. Every 2,000 miles, also remove air cleaner and wash all parts. (Brake Vacuum Cylinder) Every 3 months remove brake vacuum cylinder air cleaner, located under hood, clean hair and reoil with used crankcase oil or OE.
3. **CRANKCASE** — Drain only when engine is hot. Refill to FULL mark on gage. Run engine a few minutes and recheck oil level. **CAUTION:** Be sure pressure gage indicates oil is circulating. See Table.
4. **INTERVALS** indicated are for normal service. For extreme conditions of speed, heat, water, mud, snow, rough roads, dust, etc., change crankcase oil and lubricate more frequently.
5. **GEAR CASES**—Check level every week, add lubricant if necessary. Check with vehicle on level ground. Drain, flush and refill at end of first 1,000 miles; thereafter as indicated at points on guide. When draining, drain immediately after operation.
6. **SHOCK ABSORBERS** — (Houde) Refill with SHOCK ABSORBER FLUID, Heavy. (Delco) Refill with SHOCK ABSORBER FLUID, Light.
7. **WHEEL BEARINGS** (Front and rear)—Remove wheel, clean and repack bearings.
8. **UNIVERSAL JOINTS** (Front wheels)—Remove level plug in rear of joint and fill through fitting in wheel hub to level of level plug hole.
9. **UNIVERSAL JOINTS AND SLIP JOINTS**—Apply lubricant to joint until it overflows at relief valve, and to slip joint until lubricant is forced from end of slip joint.
10. **OIL FILTER**—Renew filter element every 5,000 miles or oftener if necessary. After renewing element, refill crankcase to FULL mark on gage. Run engine a few minutes and recheck oil level.
11. **STARTER** — Remove starter every 5,000 miles, clean, and lubricate Bendix drive sparingly with PO.
12. **DISTRIBUTOR** — Wipe distributor breaker cam lightly with CG and lubricate breaker arm pivot with OE sparingly every 2,000 miles.
13. **OIL CAN POINTS** — Lubricate throttle and spark control rod ends, clevises, hinges, latches, bumper roller and pintle with OE every 1,000 miles.
14. **POINTS REQUIRING NO LUBRICATION** — Springs, Shock Absorber Links (some models, rubber).
15. **POINTS TO BE LUBRICATED BY ORDNANCE MAINTENANCE PERSONNEL** — Clutch Pilot Bearing, Speedometer Cable.

Notes for Figure 13

RA PD 51130

SCOUT CAR M3A1

Generator — few drops of engine oil in each well.

Engine breather — pour $\frac{1}{2}$ gallon fuel oil around inlet before draining crankcase; oil with a little engine oil.

Engine — drain, refill with 9 quarts OIL, engine, SAE 50 above 90 F; SAE 30, 90 F to 32 F; SAE 10 below 32 F.

Fuel injection pump — drain and refill with engine oil to full mark on gage.

Oil separator tank — add oil to "full" level (500 miles).

Primary fuel filter — drain, disassemble and clean elements, reassemble (every week).

Vacuum cylinder valve and linkage — spray with OIL, engine, SAE 10.
1,000 miles — grease

Engine front support trunnion — use GREASE, general purpose, No. 0 below 32 F; No. 1 above 32 F.

2,000 miles oil

Lubricating oil filter — drain filter and renew element.

Air cleaner — clean cup and refill with used crankcase oil or engine oil, seasonal grade.

6,000 miles — oil

Oil separator tank — drain and refill with $1\frac{1}{2}$ quarts OIL, engine, SAE 30 above 32 F; SAE 10 below 32 F.

12,000 miles — oil or grease

Water pump — remove pipe plug, fill with GREASE, water pump until ejected from relief hole on top.

Final stage fuel filter — replace with new filter.

b. Hercules Diesel.

1,000 miles — oil

Starter motor — 8-10 drops engine oil in each well.

Generator — a few drops of engine oil in each well.

Water pump — few drops engine oil in well (weekly)

Engine — drain, refill with 7 quarts OIL, engine, SAE 30 above +10 F; SAE 10 below +10 F.

Fuel injection pump — drain, refill through dip stick hole.

Governor — 3 teaspoonfuls clean engine oil in oiler.

Lubricating oil filter — drain, disassemble, clean elements, replace (twice a week).

Primary and secondary fuel filters — drain, disassemble, clean elements (every week).

Oil separator tank — add sufficient oil to maintain level (500 miles).
1,000 miles — grease

LUBRICATION

Engine front support trunnion — use **GREASE**, general purpose No. 1 above 32 F; No. 0 below 32 F.

2,000 miles — oil

Air cleaner — clean cup and refill with used crankcase oil or engine oil, seasonal grade.

Oil filler cap — remove, wash in **SOLVENT**, dry-cleaning, and reoil.

6,000 miles — oil

Oil separator tank — drain and refill with 1½ quarts **OIL**, engine, **SAE 30** above 32 F; **SAE 10** below 32 F.

12,000 miles — grease

Fan bearings — remove pipe plug, fill with **GREASE**, general purpose, seasonal grade.

23. METHODS.

a. Lubricants are applied to the vehicles by employing the equipment provided.

b. Friction and vibration tend to develop squeaks, groans, improper fitting of rubber chassis parts, instrument panel accessories and engine mounts. Lubricants such as mineral oil, castor oil, engine oil, or other greases, must not be used by reason of their tending to swell or to rot the rubber. A suitable lubricating material can be made by mixing colloidal graphite with **ETHYLENE GLYCOL** or **GLYCERINE**, and adding enough water to prevent rapid drying before the solution has penetrated. The solution can be applied with an ordinary spray, but a needle spray will be needed to force the lubricant between parts having close clearance. Rubber parts which are used to keep other parts from slipping or rotating should not be lubricated.

24. ENGINE LUBRICATING SYSTEM.

Continuous pressure lubrication is supplied to all main and connecting rod bearings and to the timing gear. The cylinder bores are lubricated by means of the mist of oil thrown off around the connecting rod bearings.

a. **Oil Filter.** The oil filter is secured to the engine on the right side of the timing gear cover. The filter on the Diesel engines is a replaceable cartridge type. The filter on the gasoline engine must be replaced as a unit.

(1) The frequency of replacement of the filter or cartridge will depend on the oil used and on operating and atmospheric conditions.

(2) After replacement, and after running the engine for a few minutes, check the oil level; and, if necessary, add oil to bring the level to the full mark.

SCOUT CAR M3A1

b. **Oil Level.** The oil level is measured on the right side of the crankcase with a bayonet-type gage. The oil level should be checked daily and maintained at or near the "full" mark on the gage. In checking the oil level, the gage blade should be removed and cleaned and then reinserted in the reservoir to determine the oil level accurately.

c. **Servicing.** The crankcase should be drained and refilled with fresh oil, according to the lubrication chart. If the oil pan is dropped, all parts, including the screen, must be cleaned thoroughly. **CAUTION:** The bayonet-type oil gage is bent at approximately the center of its length to about a 30-degree angle. This permits it to reach full depth without coming in contact with the oil pump strainer screen. This curve should be maintained, as the placing of a straight bayonet gage in this motor will pierce the strainer screen and allow dirt from the crankcase to enter the oil pump.

d. **CAUTION:** Oil should be drained when the engine is hot, such as after a day's run, because the oil will then be agitated, flow more freely, and carry off more sediment. *Kerosene must not be used for flushing.* In replacing the fixed oil strainer on the line to the pump, care should be exercised to secure proper fits of washers and tubing to prevent entrance of dirty oil and sludge into the system. A tight joint must be secured between the oil pan, the crankcase, and flywheel housing, especially at the corners or angles. After all cap screws are started, draw them up gradually and progressively. Whenever it is suspected that the oil in an engine has become frozen, the bayonet oil level gage should be removed and examined to see whether or not the adhering oil is in a solid, plastic or liquid state.

25. DETAILED LUBRICATION AND SERVICE INSTRUCTIONS.

a. **Shock Absorbers.** Two types of shock absorbers were used in the production of these vehicles.

(1) Those equipped with Houde shock absorbers require shock absorber fluid, heavy.

(2) Those equipped with Delco shock absorbers require shock absorber fluid, light.

(3) Reference is made to figure 14 for correct identification.

b. Brake Vacuum Cylinder.

(1) Disconnect linkage every 10,000 miles.

(2) Remove pipe plug at front end of power unit and add two ounces of OIL, engine, SAE 10.

(3) Manipulate piston by hand to insure proper spread of lubricant.

(4) Replace pipe plug and connect linkage.

c. Brake Fluid Reservoir.

(1) Inspect level of brake fluid in reservoir every 1,000 miles.

LUBRICATION

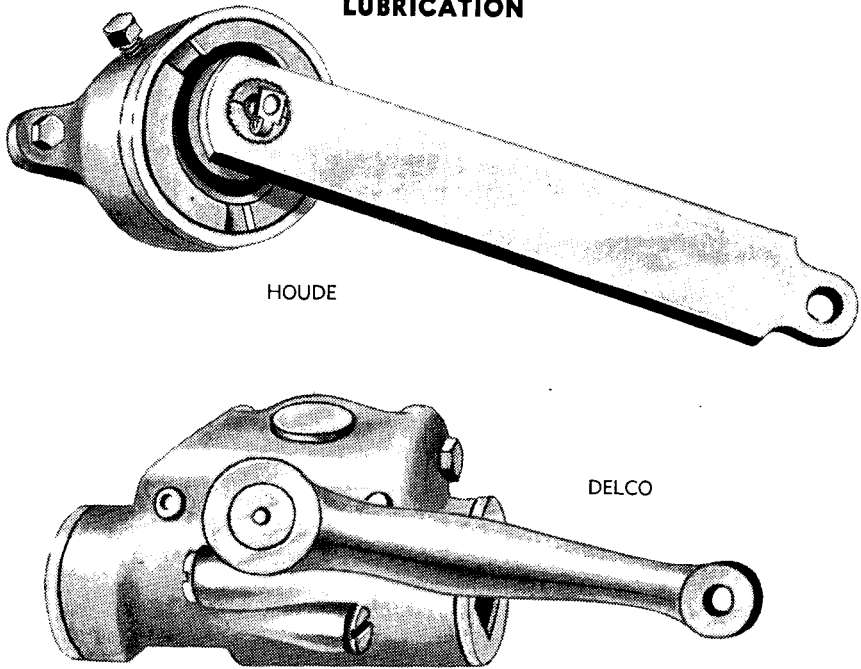

Figure 14 — Types of Shock Absorbers

RA PD 41811

(2) Add sufficient hydraulic brake fluid to bring level $\frac{3}{4}$ inch from the top.

(3) Report at once any excessive loss or leakage.

d. Fuel System.

(1) Drain water from sediment bowl when lubricating chassis.

(2) Remove and wash filter screens every 5,000 miles, or more often, if necessary.

e. Battery.

(1) Keep battery cells filled with distilled water to a depth of $\frac{1}{2}$ inch above plates.

(2) Clean and coat terminals lightly with GREASE, general purpose, after cleaning.

(3) Keep terminal connections tight.

f. Reports and Records.

(1) **REPORTS.** If lubrication instructions are closely followed, proper lubricants used, and satisfactory results are not obtained, a report will be made to the ordnance officer responsible for the maintenance of the materiel.

(2) **RECORDS.** A complete record of lubrication servicing will be kept for the materiel.

SCOUT CAR M3A1

Section VI

CARE AND PRESERVATION

	Paragraph
Cleaning	26
Painting	27
Preparing for painting	28
Painting metal surfaces	29
Paint as a camouflage	30
Removing paint	31
Painting lubricating devices	32

26. CLEANING.

a. Grit, dirt, and mud are the sources of greatest wear to a vehicle. If deposits of dirt and grit are allowed to accumulate, particles will soon find their way into bearing surfaces, causing unnecessary wear and eventually serious difficulty. Before removing engine parts or any other units, making repairs and replacements, or inspecting where working joints or bearing surfaces are to be exposed, carefully remove all dirt and grit that might find their way to the exposed surfaces. Use clean tools and exercise care to eliminate the possibilities of brushing dirt or grit accidentally into the openings. To cut oil-soaked dirt and grit, or road oil, use SOLVENT, dry-cleaning, applied with waste, rags, or a brush.

b. The vehicle is so designed that the possibility of interfering with its proper operation by the careless application of cleaning water is very small. However, care should be taken to keep water from the engine. Water should not be permitted to stand on exposed metal parts as it will cause rust. Such exposed parts shall be painted as soon as conditions permit. Rust may be softened by using SOLVENT, dry cleaning or penetrating oil, then removed by scraping with a piece of wood. Oilholes which have become clogged should be opened with a piece of wire; wood should never be used for this purpose, as splinters are likely to break off and permanently clog the passages.

27. PAINTING.

a. Ordnance materiel is painted before issue to the using arms and one maintenance coat per year will ordinarily be ample for protection. With but few exceptions this materiel will be painted with ENAMEL, synthetic, olive drab, lusterless. The enamel may be applied over old coats of long oil enamel and oil paint previously issued by the Ordnance Department if the old coat is in satisfactory condition for repainting.

CARE AND PRESERVATION

b. Paints and enamels are usually issued ready for use and are applied by brush or spray. They may be brushed on satisfactorily when used unthinned in the original package consistency or when thinned no more than 5 percent by volume with THINNER. The enamel will spray satisfactorily when thinned with 15 percent by volume of THINNER. (Linseed oil must not be used as a thinner since it will impart a luster not desired in this enamel.) If sprayed, the enamel dries hard enough for repainting within ½ hour and dries hard in 16 hours.

c. Certain exceptions to the regulations concerning painting exist. Fire-control instruments, sighting equipment, and other items which require a crystalline finish will not be painted with olive drab enamel.

d. Complete information on painting is contained in TM 9-850.

28. PREPARING FOR PAINTING.

a. If the base coat on the materiel is in poor condition, it is more desirable to strip the old paint from the surface than to use sanding and touch-up method. After stripping, it will then be necessary to apply a primer coat.

b. PRIMER, ground, synthetic, should be used on wood as a base coat for synthetic enamel. It may be applied either by brushing or spraying. It will brush satisfactorily as received or after the addition of not more than 5 percent by volume of THINNER. It will be dry enough to touch in 30 minutes, and hard in 5 to 7 hours. For spraying, it may be thinned with not more than 15 percent by volume of THINNER. Lacquers must not be applied to the PRIMER, ground, synthetic, within less than 48 hours.

c. PRIMER, synthetic, rust inhibiting, for bare metal should be used on metal as a base coat. Its use and application is similar to that outline in paragraph 28 b above.

d. The success of a job of painting depends partly on the selection of a suitable paint, but also largely upon the care used in preparing the surface prior to painting. All parts to be painted should be free from rust, dirt, grease, kerosene, oil, and alkali, and must be dry.

29. PAINTING METAL SURFACES.

a. If metal parts are in need of cleaning, they should be washed in a liquid solution consisting of ½ pound of SODA ASH in 8 quarts of warm water, or an equivalent solution, then rinsed in clear water and wiped thoroughly dry.

b. Wood parts in need of cleaning should be treated in the same manner, but the alkaline solution must not be left on for more than a few minutes and the surfaces should be wiped dry as soon as they are washed clean.

SCOUT CAR M3A1

c. When artillery or automotive equipment is in fair condition and only marred in spots, the bad places should be touched with ENAMEL, synthetic, olive drab, lusterless, and permitted to dry. The whole surface should then be sandpapered with PAPER, flint, No. 1, and a finish coat of ENAMEL, synthetic, olive drab, lusterless, applied and allowed to dry thoroughly before the materiel is used.

d. If the equipment is in bad condition, all parts should be thoroughly sanded with PAPER, flint, No. 2, or equivalent, given a coat of PRIMER, ground, synthetic, and permitted to dry for at least 16 hours. They will then be sandpapered with PAPER, flint, No. 00, wiped free from dust and dirt, and a final coat of ENAMEL, synthetic, olive drab, lusterless, applied and allowed to dry thoroughly before the materiel is used.

30. PAINT AS A CAMOUFLAGE.

Camouflage is now a major consideration in painting ordnance vehicles, with rust prevention secondary. The camouflage plan at present employed utilizes three factors: color, gloss and stenciling.

a. **Color.** Vehicles are painted with ENAMEL, synthetic, olive drab, lusterless, which was chosen because it blends in reasonably well with the average landscape.

b. **Gloss.** The new lusterless enamel makes a vehicle difficult to see from the air or from relatively great distances over land. A vehicle painted with ordinary glossy paint can be detected more easily and at greater distances.

c. **Stenciling.** White stencil numbers on vehicles have been eliminated because they can be photographed from the air. A blue drab stencil enamel is now used which cannot be so photographed. It is illegible to the eye at distances exceeding 75 feet.

d. Preserving Camouflage.

(1) Continued friction or rubbing must be avoided, as it will smooth the surface and produce a gloss. The vehicle should not be washed more than once a week. Care should be taken to see that the washing is done entirely with a sponge or a soft rag. The surface should never be rubbed or wiped, except while wet, or a gloss will develop.

(2) It is not desirable that vehicles, painted with lusterless enamel, be kept as clean as vehicles with glossy paint. A small amount of dust increases the camouflage value. Grease spots should be removed with SOLVENT, dry cleaning. Whatever portion of the spot cannot be so removed should be allowed to remain.

CARE AND PRESERVATION

(3) Continued friction of wax-treated tarpaulins on the sides of a vehicle will also produce a gloss, which should be removed with SOLVENT, dry cleaning.

(4) Tests indicate that repainting with olive drab paint will be necessary once yearly, with blue drab paint twice yearly.

31. REMOVING PAINT.

a. After repeated paintings, the paint may become so thick that it cracks and scales off in places, presenting an unsightly appearance. If such is the case, remove the old paint by use of a lime-and-lye solution (see TM 9-850 for details) or by REMOVER, paint and varnish.

b. It is important that every trace of lye or other paint remover be completely rinsed off and that the equipment be perfectly dry before repainting is attempted. It is preferable that the use of lye solutions be limited to iron or steel parts. If used on wood, the lye solution must not be allowed to remain on the surface for more than a minute before being thoroughly rinsed off and the surface wiped dry with rags.

c. Crevices or cracks in wood should be filled with putty and the wood sandpapered before refinishing. The surfaces thus prepared should be painted according to directions in paragraph 29.

32. PAINTING LUBRICATING DEVICES. Oil cups, grease fittings, oilholes, and similar lubricating devices, as well as a circle about three-fourths of an inch in diameter at each point of lubrication, should be painted with ENAMEL, red, water-resisting, so that they can be readily located. Avoid painting the openings of the fittings through which the lubricant passes.

SCOUT CAR M3A1

Section VII

TOOLS AND EQUIPMENT ON VEHICLE

	Paragraph
Introduction	33
Equipment	34
Tools	35
Ordnance motor book.....	36
Manuals	37

33. INTRODUCTION.

The materiel indicated herein includes tools and equipment for general care, maintenance, and preservation; an Ordnance Motor Book to record the vehicle history; commercial manuals pertinent to vehicle operation and parts. Accessories should not be used for purposes other than as prescribed and when not in use should be stored in the places or receptacles provided.

34. EQUIPMENT.

Equipment issued with the Scout Car is listed below.

a. Accessories.

(1) Accessories carried on outside of vehicle include:

Ax	Mattock, pick
Bag, top	Shovel
Bucket, water	Strap, leather
Cable, towing	Top

(2) Accessories carried inside of vehicle include:

Book, ordnance motor	Extinguisher, fire
Chain, non-skid	Goggles
Cover, crosscut saw	Guide, lubrication, War Dept.
Cover, headlight	Lamp, inspection
Crank, starting	Pad, track, 30-in.
Cushion, seat	Pad, track 39-in.
Cushion, seat, driver and commander	Saw, crosscut

b. Armament Accessories. Information pertaining to the spare parts and accessories issued with each gun and mount will be found in pertinent Standard Nomenclature Lists and appropriate Field Manuals.

35. TOOLS.

a. Tools issued with these vehicles are reviewed in Standard Nomenclature List No. G-67.

TOOLS AND EQUIPMENT ON VEHICLE

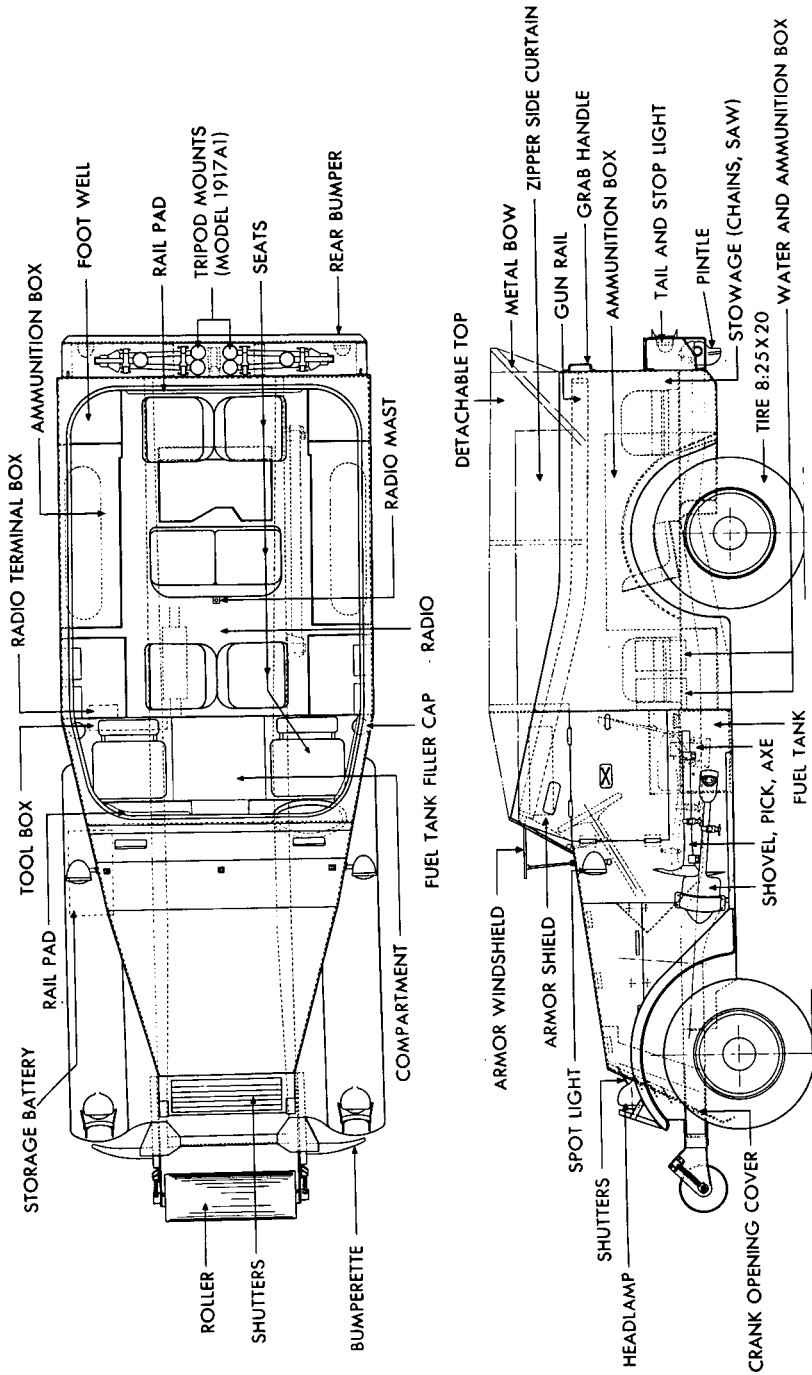

Figure 15 — Equipment Installation

RA PD 13036

SCOUT CAR M3A1

b. **Kits.** Included in the tool kit assembly are the following:

Bag	Wrench, crescent
Gun, alemite lever	Wrench, double-end, $\frac{7}{16}$ -in. by $\frac{1}{2}$ -in.
Hammer, ball peen	Wrench, double-end, $\frac{3}{8}$ -in. by $\frac{1}{16}$ -in.
Handle, wheel wrench	Wrench, double-end, $\frac{5}{8}$ -in. by $\frac{3}{4}$ -in.
Handle, wrench	Wrench, double-end, $\frac{1}{16}$ -in. by $\frac{1}{16}$ -in.
Lever, hydraulic jack	Wrench, double-end, 1-in. by $1\frac{5}{16}$ -in.
Oiler	Wrench, socket head set screw
Pliers, combination	Wrench, spark plug
Screwdriver, 6-in.	Wrench, wheel bearing nut socket
Screwdriver, 8-in.	Wrench, wheel nut socket

c. **Preservation of Tools.** It is desirable to protect the tools supplied with the vehicle from becoming rusty through exposure. Adequate protection can be provided by periodically cleaning the surfaces of the tools, and coating them with a film of engine oil of the same type and grade as that which is being used in the engine. The oil may be applied with a saturated swab. However, the swab should be disposed of in such a manner that the fire hazard therefrom will be minimized.

(1) In order to avoid the accumulation of water in the tool box, a $\frac{1}{4}$ -inch hole may be drilled through the lowest portion of the tool box bottom and appropriately countersunk to remove any bur.

(2) Thoroughly clean the inside of the tool box and paint all exposed metal surfaces. After the paint has dried, apply a film of engine oil to the inside surfaces of the tool box.

36. ORDNANCE MOTOR BOOK.

An accurate record must be kept of each automotive vehicle issued by the Ordnance Department. For this purpose, the Ordnance Motor Book or "Log Book" is issued with each vehicle and should accompany it in service at all times. The book will be kept in a canvas cover to protect it from damage. Instructions for making the entries are printed within the binder. **NOTE:** Data pertaining to the records of assignment must be removed and destroyed prior to entering combat. All other references which may be posted regarding the identity of the organization must also be deleted.

37. MANUALS.

Manufacturers' manuals describing operations and maintenance, and listing parts, are usually shipped with the vehicles for initial delivery. Such publications are a part of the equipment, should accompany the vehicle at all times, or be available within the organization, and be transferred with the vehicle.

Section VIII

MATERIEL AFFECTED BY GAS

	Paragraph
Protective measures	38
Cleaning	39
Decontamination	40
Special precautions for automotive materiel.....	41

38. PROTECTIVE MEASURES.

a. When materiel is in constant danger of gas attack, unpainted metal parts will be lightly coated with engine oil. Instruments are included among the items to be protected in this manner from chemical clouds or chemical shells, but ammunition is excluded. Care will be taken that the oil does not touch the optical parts of instruments or leather or canvas fittings. Materiel not in use will be protected with covers as far as possible. Ammunition will be kept in sealed containers.

b. Ordinary fabrics offer practically no protection against mustard gas or lewisite. Rubber and oilcloth, for example, will be penetrated within a short time. The longer the period during which they are exposed, the greater the danger of wearing these articles. Rubber boots worn in an area contaminated with mustard gas may offer grave danger to men who wear them several days after the bombardment. Impermeable clothing will resist penetration more than an hour, but should not be worn longer than this.

39. CLEANING.

a. All unpainted metal parts of materials that have been exposed to any gas except mustard and lewisite must be cleaned as soon as possible with SOLVENT, dry cleaning, or ALCOHOL, denatured, and wiped dry. All parts should then be coated with engine oil.

b. Ammunition which has been exposed to gas must be thoroughly cleaned before it can be fired. To clean ammunition use AGENT, decontaminating, non-corrosive, or if this is not available, strong soap and cool water. After cleaning, wipe all ammunition dry with clean rags. *Do not use dry powdered AGENT, decontaminating (chloride of lime) which is used for decontaminating certain types of materiel on or near munition supplies, as flaming occurs through the use of chloride of lime on liquid mustard.*

40. DECONTAMINATION.

For the removal of liquid chemicals (mustard, lewisite, etc.) from materiel, the following steps should be taken:

a. Protective measures.

(1) For all of these operations a complete suit of impermeable cloth-

SCOUT CAR M3A1

ing and a service gas mask will be worn. Immediately after removal of the suit, a thorough bath with soap and water (preferably hot) must be taken. If any skin areas have come in contact with mustard, if even a very small drop of mustard gets into the eye, or if the vapor of mustard has been inhaled, it is imperative that complete first-aid measures be given within 20 to 30 minutes after exposure. First-aid instructions are given in TM 9-850 and FM 21-40.

(2) Garments exposed to mustard will be decontaminated. If the impermeable clothing has been exposed to vapor only, it may be decontaminated by hanging in the open air, preferably in sunlight, for several days. It may also be cleaned by steaming for 2 hours. If the impermeable clothing has been contaminated with liquid mustard, steaming for 6 to 8 hours will be required. Various kinds of steaming devices can be improvised from materials available in the field.

b. Procedure.

(1) Commence by freeing materiel of dirt through the use of sticks, rags, etc., which must be burned or buried immediately after this operation.

(2) If the surface of the materiel is coated with grease or heavy oil, this grease or oil should be removed before decontamination is begun. SOLVENT, dry cleaning, or other available solvents for oil should be used with rags attached to ends of sticks. Following this, decontaminate the materiel with bleaching solution made by mixing one part AGENT, decontaminating (chloride of lime), with one part water. This solution should be swabbed over all surfaces. Wash off with water, dry, and oil all surfaces.

(3) All unpainted metal parts and instruments exposed to mustard or lewisite must be decontaminated with AGENT, decontaminating, noncorrosive, mixed 1 part solid to 15 parts solvent (ACETYLENE TETRACHLORIDE). If this is not available, use warm water and soap. Bleaching solution must not be used because of its corrosive action. Instrument lenses may be cleaned only with PAPER, lens tissue, using a small amount of ALCOHOL, ethyl. Coat all metal surfaces lightly with engine oil.

(4) In the event AGENT, decontaminating (chloride of lime), is not available, materiel may be temporarily cleaned with large volumes of hot water. However, mustard lying in joints or in leather or canvas webbing is not removed by this procedure and will remain a constant source of danger until the materiel can be properly decontaminated. All mustard washed from materiel in this manner lies unchanged on the ground, necessitating that the contaminated area be plainly marked with warning signs before abandonment.

MATERIEL AFFECTED BY GAS

(5) The cleaning or decontaminating of materiel contaminated with lewisite will wash arsenic compounds into the soil, poisoning many water supplies in the locality for either men or animals.

(6) Leather or canvas webbing that has been contaminated should be scrubbed thoroughly with bleaching solution. In the event this treatment is insufficient, it may be necessary to burn or bury such materiel.

(7) Detailed information on decontamination is contained in FM 21-40, TM 9-850 and TC 38, 1941, Decontamination.

41. SPECIAL PRECAUTIONS FOR AUTOMOTIVE MATERIEL.

a. When vehicles have been subjected to gas attack with the engine running, the air cleaner should be serviced by removing the oil, flushing with SOLVENT, dry cleaning, and refilling with the proper grade of oil.

b. Instrument panels should be cleaned in the same manner as outlined for instruments.

c. Contaminated seat cushions will be discarded.

d. Washing the compartments thoroughly with bleaching solution is the most that can be done in the field. Operators should constantly be on the alert, when running under conditions of high temperatures, for slow vaporization of the mustard or lewisite.

e. Exterior surfaces of vehicles will be decontaminated with bleaching solution. Repainting may be necessary after this operation.

SCOUT CAR M3A1

PART II — ORGANIZATIONAL MAINTENANCE

Section IX

SCOPE OF MAINTENANCE OPERATIONS

	Paragraph
Scope	42
Definition of terms.....	43
Allocation of repairs.....	44
Trouble shooting, general.....	45

42. SCOPE.

The scope of maintenance and repairs by the vehicle crews and maintenance personnel of the using arm is determined by the ease with which the project can be accomplished, the amount of time available, weather conditions, concealment, shelter, proximity to hostile fire, equipment and parts available, and skill of personnel. Since all of these factors are variable, no exact system or procedure can be prescribed or followed.

43. DEFINITION OF TERMS.

a. Servicing. Comprises cleaning, lubricating, tightening bolts and nuts, and making external adjustments of subassemblies or assemblies and controls.

b. Repairing. Comprises making repairs to or replacement of the part, subassembly, or assembly that can be accomplished without disassembling completely the materiel concerned, and does not require heavy welding or riveting, machining, fitting, and/or alining.

c. Replacing. Comprises removing the part, subassembly, or assembly from the vehicle and exchanging it for a new, reconditioned, or rebuilt part, subassembly or assembly, as the case may be.

44. ALLOCATION OF REPAIR JOBS.

The list of operations that follows may be performed by personnel of the using arm without securing permission from ordnance maintenance personnel. Additional and more complicated maintenance operations (removal and reinstallation of the engine, transmission, and front and rear axle group assemblies) may also be accomplished by the using arm, provided proper authority is received from ordnance maintenance personnel before the work is started.

FRONT AXLE

Alinement.....	Adjust for toe-in and turning radius
Steering knuckle.....	Replace arm

SCOPE OF MAINTENANCE OPERATIONS

BODY

Bows	Replace
Fenders	Replace
Running boards	Replace
Seats	Replace
Top	Replace
Windshield	Replace assembly
Wipers	Replace

BRAKES

Vacuum booster	Replace assembly
Brakes	Adjust; replace lines
Brake cylinders	Replace assembly
Master cylinder	Replace assembly
Shoes	Replace assembly

CLUTCH

Clutch	Adjust
Clutch	Replace assembly

COOLING SYSTEM

Belts	Adjust or replace
Fan and water pump.....	Replace assemblies
Hose and pipe.....	Replace
Radiator	Clean, flush, or replace
Thermostat (Diesel engines).....	Replace

ELECTRICAL SYSTEM

Battery.....	Replace, charge, and service
Cables	Replace assemblies
Coils and condensers.....	Replace assemblies
Distributor.....	Replace assembly; replace and adjust points
Generator	Replace assembly
Horn and relay.....	Replace assemblies
Lights	Adjust or replace assemblies
Regulator	Replace assembly
Shielding	Replace assemblies
Spark plugs	Replace
Starter	Replace assembly
Starter, Bendix	Replace assembly
Switches	Replace assemblies

ENGINE

Gaskets.....	Replace (carburetor; cylinder head; fuel pump; manifolds; oil pan; valve cover; water pump)
--------------	---

SCOUT CAR M3A1

EXHAUST SYSTEM

Manifolds	Replace assemblies
Muffler	Replace assembly
Pipes	Replace

FUEL SYSTEM

Carburetor	Replace assembly
Air cleaner	Clean or replace assembly
Filter	Clean or replace assembly
Lines	Repair or replace
Pump	Replace assembly
Tanks	Clean or replace assemblies
Injection pump (Diesel)	Replace
Injectors (Diesel)	Replace

INSTRUMENTS

Gages	Replace assemblies
Meters	Replace assemblies

LUBRICATION SYSTEM

Filter	Replace
Lines	Replace
Pan	Clean or replace
Strainer	Clean or replace assembly

SHOCK ABSORBERS AND SPRINGS

Center and shackle bolts	Replace
Shock absorbers	Service and replace assembly; replace linkage
Springs	Adjust or replace assemblies

STEERING GEAR

Steering gear	Adjust or replace assembly
Drag link	Adjust or replace assembly
Tie rod	Adjust or replace assembly

TRANSMISSION

Shift levers	Replace
Shift lever cover	Replace

WHEELS

Bearings	Adjust and replace
Grease retainers	Replace
Tires and tubes	Replace
Wheels	Replace

SCOPE OF MAINTENANCE OPERATIONS

- 45. TROUBLE SHOOTING, GENERAL.**
- a. **Front Axle.** Refer to paragraph 49.
 - b. **Rear Axle.** Refer to paragraph 54.
 - c. **Brake System.** Refer to paragraph 62.
 - d. **Clutch.** Refer to paragraph 71.
 - e. **Cooling System.** Refer to paragraphs 76, 83, and 91.
 - f. **Ignition System.** Refer to paragraph 108 and 124.
 - g. **Engine.** Refer to paragraphs 133, 148, and 164.
 - h. **Fuel System.** Refer to paragraph 187.
 - i. **Springs and Shock Absorbers.** Refer to paragraph 210.
 - j. **Steering Gear and Drag Link.** Refer to paragraph 215.
 - k. **Transmission and Transfer Case.** Refer to paragraphs 219 and 223.
 - l. **Wheels, Tires, and Bearings.** Refer to paragraph 227.

SCOUT CAR M3A1

Section X

ORGANIZATION SPARE PARTS AND ACCESSORIES

	Paragraph
Organization spare parts.....	46
Accessories	47

46. ORGANIZATION SPARE PARTS.

a. A set of organization spare parts is supplied to the using arm for field replacement of those parts most likely to become broken, worn, or otherwise unserviceable. The set is kept complete by requisitioning new parts for those used. Organization spare parts are listed in pertinent Standard Nomenclature Lists.

b. Care of organization spare parts is covered in the section of this manual entitled "Care and Preservation" (section VI).

47. ACCESSORIES.

a. Accessories include tools and equipment required for such disassembling and assembling as the using arm is authorized to perform, and for the cleaning and preservation of the gun carriage, ammunition, etc. They also include chests, covers, tool rolls, and other items necessary to protect the materiel when it is not in use, or when traveling. Accessories should not be used for purposes other than those prescribed, and when not in use should be properly stored.

b. Accessories provided are listed in pertinent Standard Nomenclature Lists, or see section VII of this manual.

Section XI

FRONT AXLE

	Paragraph
Description	48
Trouble shooting	49
Maintenance and adjustments.....	50
Removal of front axle assembly.....	51
Installation of front axle assembly.....	52

48. DESCRIPTION (figs. 16 and 17). The front axle is of the spiral-bevel, single-reduction, full-floating type, with a straddle-mounted pinion gear and a standard-type differential. The front wheels are driven through Rzeppa-type universal joints enclosed within knuckles at the outer ends of the axle housing.

49. TROUBLE SHOOTING.

Symptom and Probable Cause	Probable Remedy
a. Hard Steering.	
Front axle shifted.	Relocate and tighten spring clip nuts.
Lack of lubrication.	Lubricate tie rod yoke, steering gear, and steering drag link.
Improper toe-in.	Adjust tie rod yoke.
Tires under-inflated.	Inflate tires to correct pressure (par. 226c).
Bent frame.	Report to ordnance personnel.
Excessive caster.	Report to ordnance personnel.
b. Shimmy.	
Knuckle bearings loose or worn.	Readjust or replace.
Tie rod loose.	Tighten or replace worn parts.
Front axle shifted.	Relocate and tighten spring clip nuts.
Insufficient toe-in.	Readjust at tie rod yoke.
Steering gear loose.	Tighten.
Excessive or insufficient caster.	Report to ordnance personnel.
c. Wandering.	
Spring center bolt sheared and axle shifted.	Replace center bolt and relocate in spring seat.
Tight steering.	Adjust steering gear.
Brake dragging.	Adjust.
Tires unevenly inflated.	Inflate to proper pressure (par. 226b).
Bent axle parts.	Report to ordnance personnel.
Loose front wheel bearings.	Adjust.

SCOUT CAR M3A1

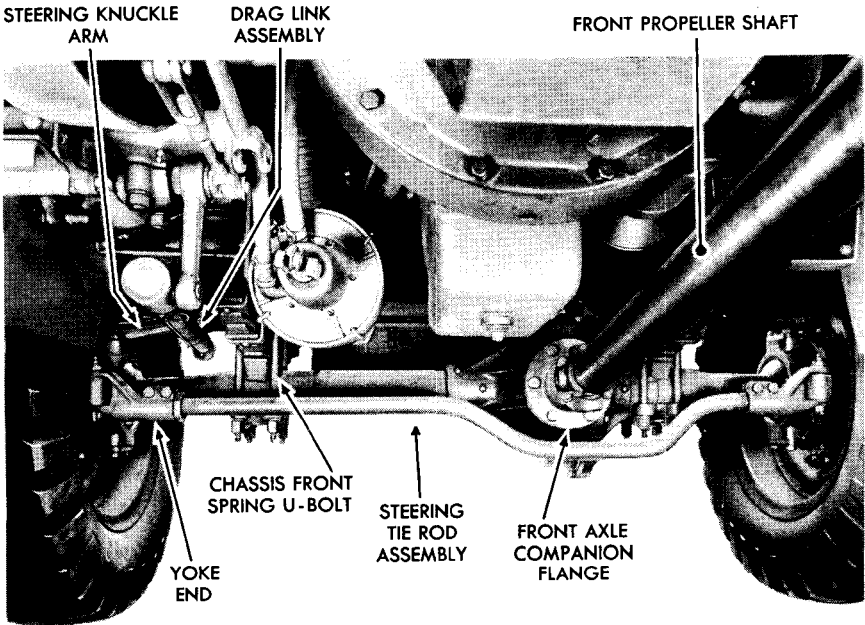
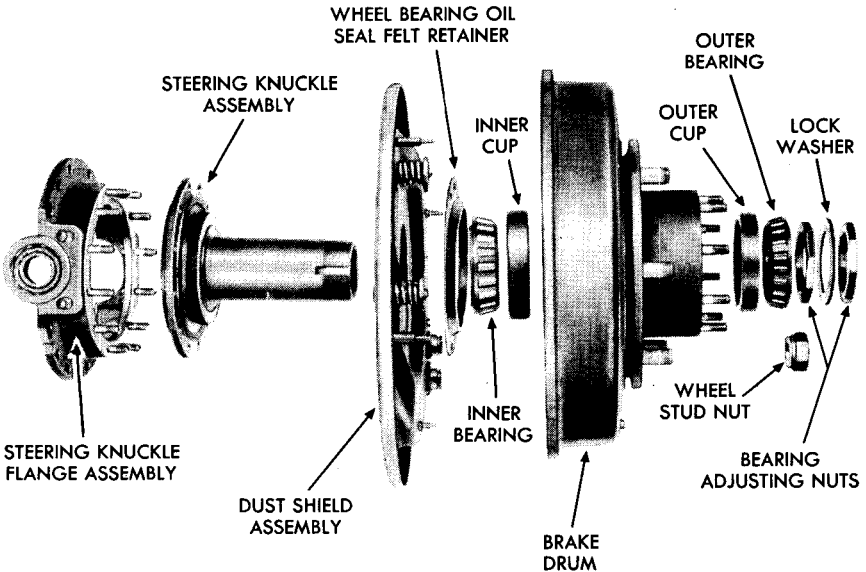

Figure 16 — Front Axle, Installed - Rear View RA PD 13037



RA PD 13038

Figure 17 — Wheel Bearings, Brake Drum, and Steering Knuckle - Exploded

FRONT AXLE

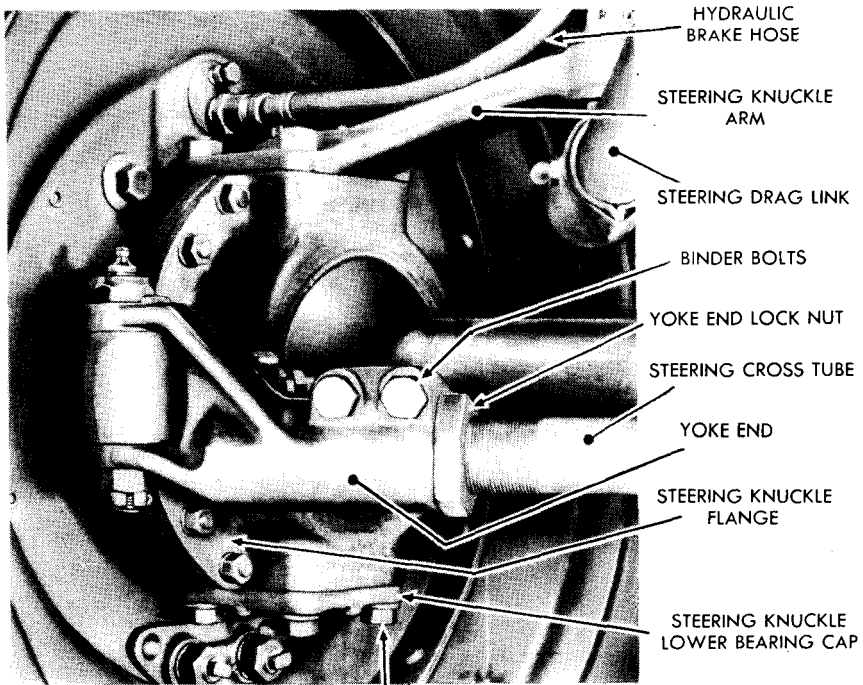

RA PD 13039

Figure 18 — Front Axle Steering Knuckle

50. MAINTENANCE AND ADJUSTMENTS.

a. Steering Knuckle Bearing Adjustment.

Jacks, two

Wrench, socket, $\frac{3}{4}$ -in., and
ratchet extension.

(1) Jack up the axle and remove the drag link and the lower steering knuckle flange bearing cap.

(2) Remove the four nuts which retain the upper bearing cap. Remove the hydraulic brake hose from the brake cylinder. This will allow the upper bearing cap and steering knuckle arm to be removed.

(3) Adjust the bearings by means of shims located under these caps. Shim packs must be the same thickness. Add shims to loosen bearings and remove shims to tighten bearings.

(4) Install the caps.

(5) The bearings should be adjusted until there is no end play of the knuckle assembly, but it should oscillate freely.

(6) Then remove the caps again and reduce the shim pile 0.005 inch under each cap.

SCOUT CAR M3A1

(7) After replacing the caps, there should be a small amount of drag in rotating the steering knuckle but it should not bind. Replace brake hose and drag link and bleed brake cylinder.

b. Toe-in Adjustment.

Extension, ratchet

Stick, measuring or toe-in
indicating apparatus

Wrench, open-end, $\frac{7}{8}$ -in.

Wrench, socket, $1\frac{1}{8}$ -in.

Wrench, socket, $1\frac{5}{16}$ -in.

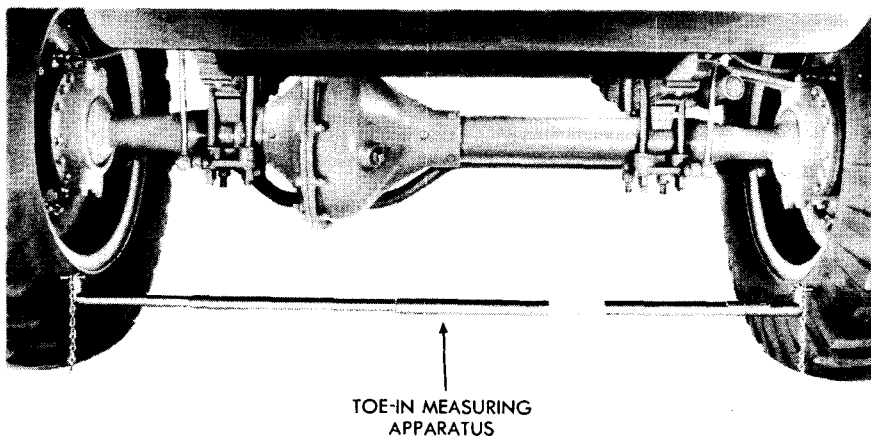

RA PD 13041

Figure 19 — Toe-in Adjustment

(1) The front wheels are not parallel when in the position of straight ahead running, but are closer together at the front than at the rear. This is called toe-in. Toe-in has the effect of causing the natural paths of the wheels to approach each other, and is introduced for the purpose of counteracting the tendency of the wheels to separate as a result of camber. Wheel toe-in is originally set at $\frac{1}{8}$ inch, plus or minus $\frac{1}{16}$ inch, and should be maintained at this figure (fig. 20).

(2) A coarse toe-in adjustment can be made by disconnecting a cross-tube end and turning it in or out on the cross-tube not less than one complete turn (fig. 18).

(3) For a finer adjustment, it is necessary to give the cross-tube a complete turn. A cross-tube of the tie rod assembly has different and opposite pitch threads on each end.

(a) Disconnect one end of the tie rod at the pin end of the yoke by removing the cotter pin and castellated nut and removing the pin. Then, loosen the binder bolts on each cross-tube (fig. 18).

(b) While holding the ends rigid, give the cross-tube a complete

FRONT AXLE

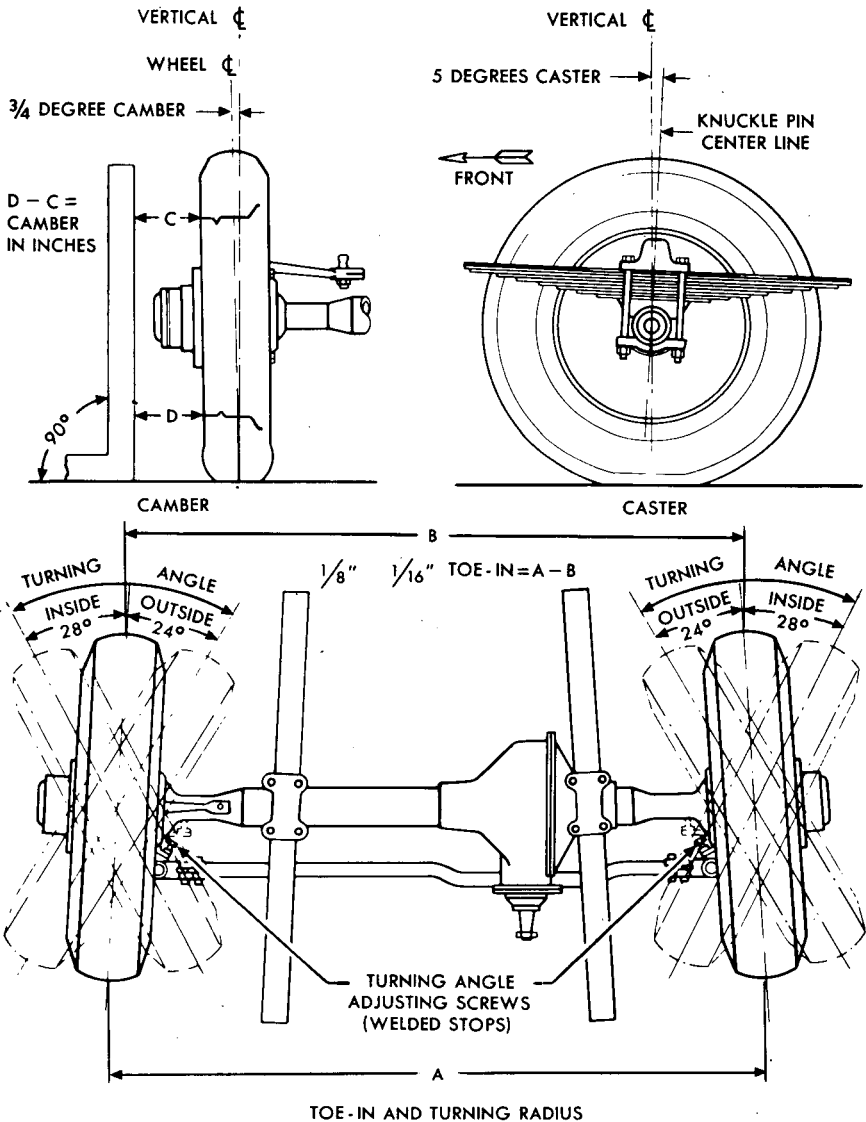

RA PD 3515

Figure 20 — Front Axle Alignment Chart

turn, increasing or decreasing the effective length, depending upon which direction the tube is rotated. The length should be adjusted to produce the proper toe-in (fig. 20).

(c) After correct adjustment has been obtained, bolts, yoke, and pin must be secured in position once more.

SCOUT CAR M3A1

FRONT SHOCK ABSORBER CONNECTING LINK

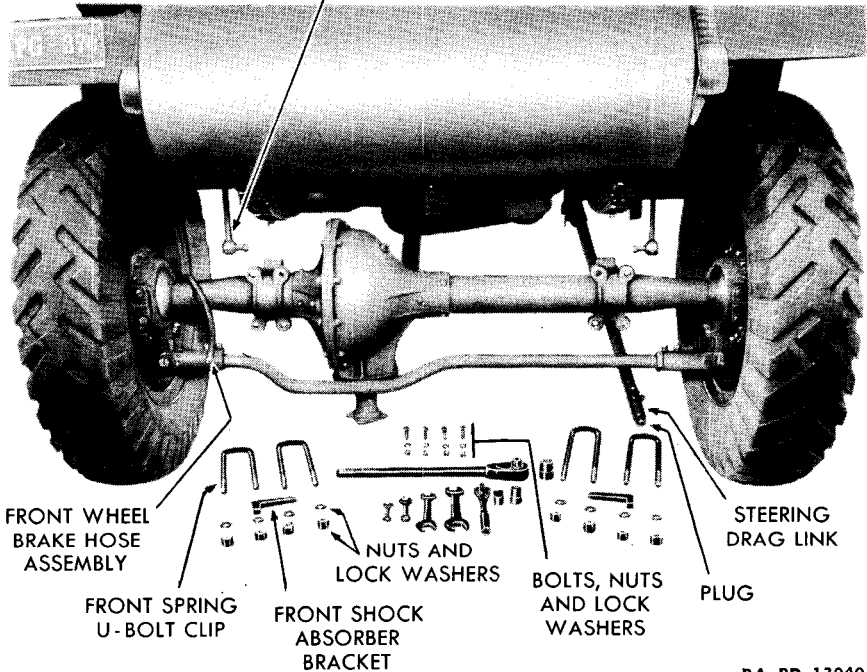

RA PD 13040

Figure 21 — Front Axle Removal

51. REMOVAL OF FRONT AXLE ASSEMBLY.

- | | |
|---------------------------------------|--------------------------------------|
| Jack | Wrench, open-end, $\frac{3}{4}$ -in. |
| Link, drag | Wrench, open-end, $\frac{1}{2}$ -in. |
| Stands, jack, two | Wrench, plug or heavy screw-driver |
| Wrench, box, $\frac{5}{8}$ -in. | Wrench, socket, $\frac{1}{2}$ -in. |
| Wrench, open-end, $\frac{7}{16}$ -in. | Wrench, wheel stud nut |

a. Prepare Vehicle for Work.

Wrench, wheel stud nut

Place vehicle on level spot, apply hand brake, and block rear wheels. Loosen, but do not remove the six wheel stud nuts on each wheel (fig. 17).

b. Raise Front End of Vehicle.

Stands, jack, two

Raise the front end of the vehicle and place jack stands under frame side rails, just behind front spring rear hanger bracket.

c. Disconnect Front Propeller Shaft.

Wrench, box, $\frac{5}{8}$ -in.

FRONT AXLE

Remove the four nuts, bolts, and lock washers holding propeller shaft universal joint flange to front axle companion flange and lower propeller shaft (fig. 16).

d. Disconnect Drag Link.

Screwdriver, heavy-duty

Wrench, or drag link plug

Loosen plug at front end of drag link and disengage link from steering arm stud (fig. 22).

e. Disconnect Shock Absorbers.

Wrench, socket, $\frac{1}{8}$ -in.

Remove eight U-bolt spring clip nuts and pull out U-bolt clips that hold shock absorber links to axle spring seat (fig. 16).

f. Disconnect Brake Hoses at Frame.

Wrench, open-end, $\frac{7}{16}$ -in.

Wrench, open-end, $\frac{1}{2}$ -in.

Wrench, open-end, $\frac{3}{4}$ -in.

Disconnect flared tube nut from hose fitting at inside of frame. Remove nut that holds hose assembly to frame.

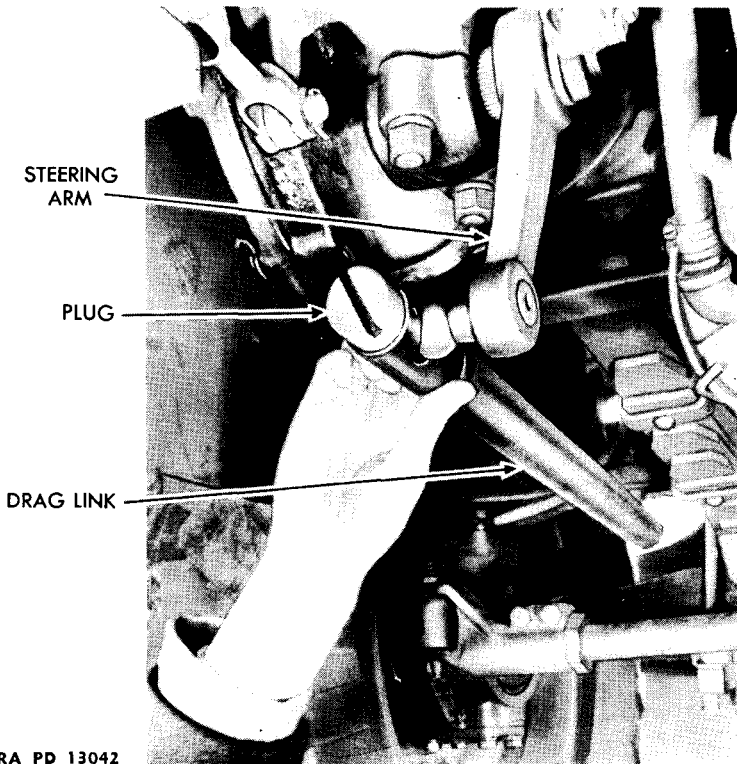

RA PD 13042

Figure 22 — Steering Drag Link

SCOUT CAR M3A1**g. Remove Axle and Wheel Assembly.**

Roll axle and wheel assembly out from under the vehicle. Hold wheels in a vertical position while removing the assembly. This is necessary as the ball and socket joint will allow the wheels to move sideways.

52. INSTALLATION OF FRONT AXLE ASSEMBLY.

Jack	Wrench, open-end, $\frac{7}{16}$ -in.
Stands, jack, two	Wrench, open-end, $\frac{3}{4}$ -in.
Wrench, box, $\frac{5}{8}$ -in.	Wrench, open-end, $\frac{1}{8}$ -in.
Wrench, drag link plug or heavy-duty screwdriver	Wrench, socket, $\frac{15}{16}$ -in.

a. Position Axle Assembly to Chassis.

Jack Stands, jack, two

Roll axle under chassis to its approximate running position. Then raise assembly until springs rest in their proper positions in spring seats.

b. Install Spring Clips.

Wrench, socket, $\frac{15}{16}$ -in.

Set spring clips U-bolts in position over springs and through spring seats (fig. 16). Install lock washers and nuts on rear clips.

c. Connect Shock Absorbers.

Wrench, socket, $\frac{15}{16}$ -in.

Slip shock absorber link plates onto front spring clips and replace clip lock washers and nuts (fig. 16). Draw up all nuts evenly.

d. Connect Drag Link.

Wrench, drag link plug, or screwdriver, heavy-duty

Set front end of drag link onto steering arm ball stud and tighten end plug (fig. 22).

e. Connect Propeller Shaft.

Wrench, box, $\frac{5}{8}$ -in.

Wrench, socket, $\frac{9}{16}$ -in.

Hold propeller shaft in normal running position and replace the bolts, lock washers and nuts holding propeller shaft flange to drive pinion companion flange (fig. 16). Tighten nuts alternately to eliminate possibility of distortion or uneven alinement.

f. Connect Brake Hoses.

Wrench, open-end, $\frac{7}{16}$ -in.

Wrench, open-end, $\frac{15}{16}$ -in.

Wrench, open-end, $\frac{3}{4}$ -in.

Slip hose fitting through frame and replace holding nut. Then connect hose to brake line by turning inverted flared tube nut onto hose fitting.

FRONT AXLE

g. Lower Front End of Vehicle.

Jack

Stands, jack, two

Raise front end of vehicle slightly, remove the jack stands, and lower vehicle until its weight rests on the wheels. Remove jack.

h. Check Wheel Alinement. Check front wheel alinement as described in paragraph 50.

i. Bleed Brake Lines. All wheel brake cylinders must be bled as described in paragraph 68.

j. Check Lubrication in Differential Housing. See Lubrication Guide, section V.

SCOUT CAR M3A1

Section XII

REAR AXLE

	Paragraph
Description	53
Trouble shooting	54
Maintenance service and adjustments.....	55
Removal of rear axle assembly.....	56
Installation of rear axle assembly.....	57

53. DESCRIPTION (fig. 23).

The rear axle is of the single-reduction, full-floating type, with a straddle mounted pinion gear and a conventional-type differential. A split-type housing is used. The drive pinion and differential assemblies are exactly the same as those used in the front axle.

54. TROUBLE SHOOTING.

Symptom and Probable Cause

Probable Remedy

a. Axle Noises.

Continuous hum.

Readjust wheel bearings.

Coasting hum.

Inspect wheel bearings. If source of trouble is not located there, report to higher authority.

Pulling hum.

Report to ordnance personnel.

b. Backlash.

Loose axle shaft flange.

Retighten.

Excessive clearance at axle shaft splines.

Replace worn parts.

Excessive pinion and bevel gear clearance.

Report to ordnance personnel.

c. Grease Leakage.

Grease appearing on brakes.

Inspect seals and replace, if necessary.

Grease squeezing through hub driving flange.

Inspect seals and breather, smooth any rough spots on flange, and tighten.

55. MAINTENANCE SERVICE AND ADJUSTMENTS.

a. Removal of Shaft (figs. 24 and 25).

Bar, pinch

Wrench, socket, $\frac{11}{16}$ -in.

Wrench, square, $\frac{3}{8}$ -in.

Wrench, socket, $\frac{5}{8}$ -in., with ratchet extension

REAR AXLE

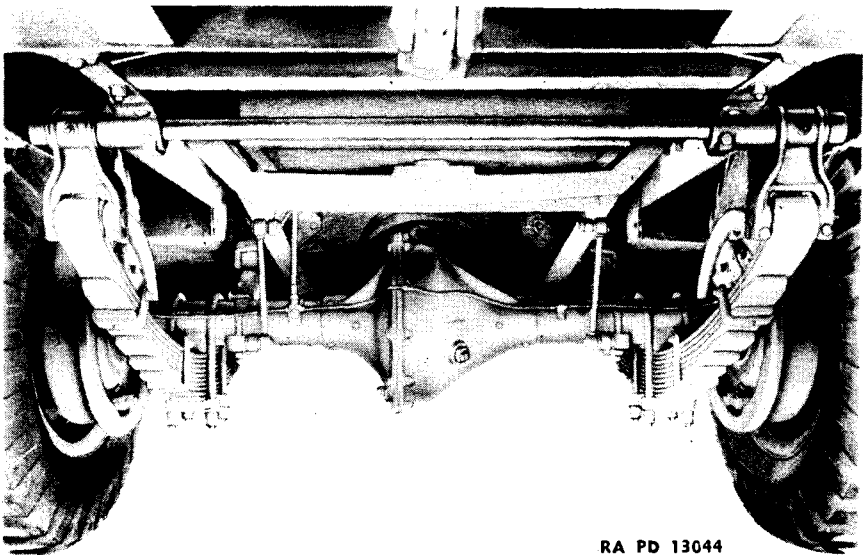

Figure 23 — Rear Axle Installed

Remove drive flange stud nuts ($\frac{5}{8}$ -in. socket wrench), lock washers, shakeproof washers and tapered split sleeves from each flange. Loosen lock nuts on flange puller screws ($\frac{3}{8}$ -in. socket wrench) and turn puller screws in to break shaft loose from differential side gears ($\frac{1}{4}$ -in. socket wrench). Replace flange stud tapered split sleeves, lock washers, necessary (fig. 25).

b. Installation of Shaft.

Wrench, socket, $\frac{3}{8}$ -in.
Wrench socket, $\frac{1}{4}$ -in.

Wrench, socket, $\frac{5}{8}$ -in.,
with ratchet extension

Insert shafts into housings until splines engage with differential side gear splines. Adjust puller screws and fasten with lock nuts ($\frac{3}{8}$ -in. socket wrench). Replace flange stud tapered split sleeves, lock washers, shakeproof washers, and nuts ($\frac{5}{8}$ -in socket wrench).

c. Rear Wheel Bearing Adjustment (fig. 26).

Bar, short

Wrench, wheel bearing nut

(1) Adjustment must be made with the axle jacked up and the axle shaft removed (par. 55 a.).

(2) Remove the locking nut and washer.

(3) Using a wheel bearing nut wrench and about an 18-inch rod,

SCOUT CAR M3A1

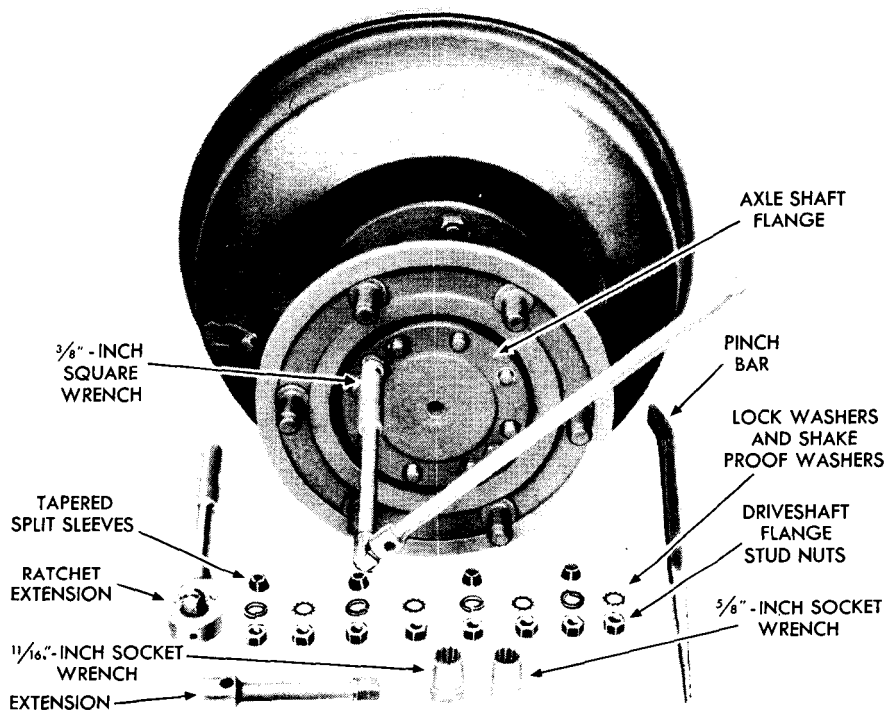

RA PD 13045

Figure 24 — Loosening Axle Shaft with Puller Screw

draw the inside adjusting nut as tightly as possible against the outer cone assembly, meanwhile rotating the wheel, first in one direction, and then in the other, until the bearings bind and the wheel turns hard. Rotating the wheel in both directions causes the rollers to become fully and evenly seated.

(4) Back off the adjusting nut $\frac{1}{8}$ of a turn, so that the wheel turns freely without perceptible end play in the bearing. It may be necessary to tap the end of the rear axle shaft housing while loosening the adjustment in order to move the cone on the axle.

(5) End play may be tested by placing the end of a short bar between the tire and the floor, and at the same time holding a finger on

REAR AXLE

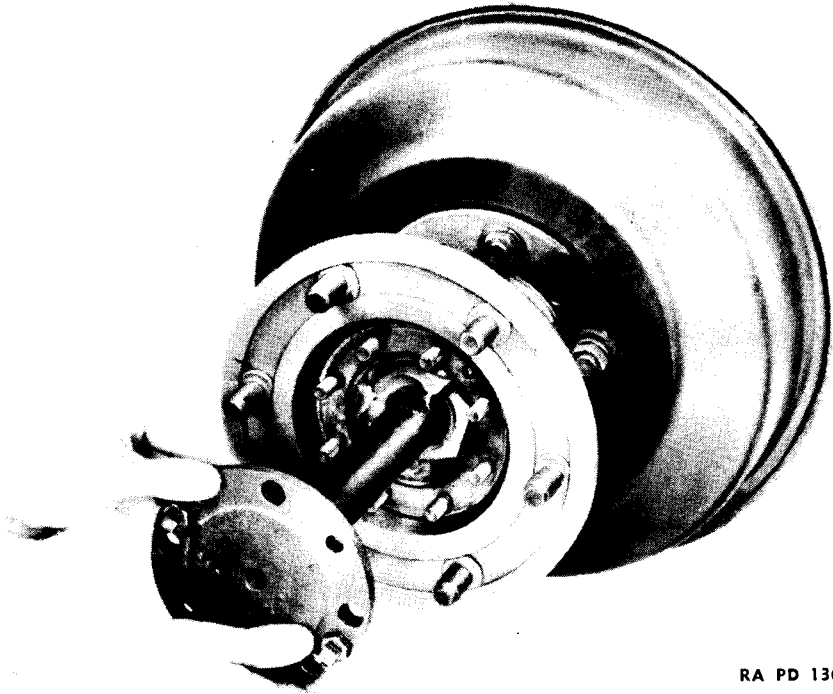

RA PD 13046

Figure 25 — Removal of Rear Axle Shaft

56. REMOVAL OF REAR AXLE ASSEMBLY (fig. 23):

- | | |
|---------------------------------------|--|
| Bar, pinch | Wrench, open-end, $\frac{5}{8}$ -in. |
| Chisel | Wrench, open-end, $\frac{3}{4}$ -in. |
| Drift | Wrench, open-end, $\frac{1\frac{5}{8}}$ -in. |
| Hammer | Wrench, socket, $\frac{9}{16}$ -in. |
| Jack | Wrench, socket, $\frac{5}{8}$ -in. |
| Stands, jack, two, or hoist | Wrench, socket, $\frac{3}{4}$ -in. |
| Wrench, open-end, $\frac{1}{2}$ -in. | Wrench, socket, $\frac{1\frac{5}{8}}$ -in. |
| Wrench, open-end, $\frac{9}{16}$ -in. | Wrench, wheel stud nut |

a. Prepare Vehicle for Work.

Wrench, wheel stud nut

Place vehicle on level spot and block front wheels so that vehicle will not move. Loosen, but do not remove wheel stud nuts on each rear wheel.

b. Raise Rear End of Vehicle.

Jack

Stands, jack, two, or hoist

Raise rear end of vehicle until stress is removed from springs. Place

SCOUT CAR M3A1

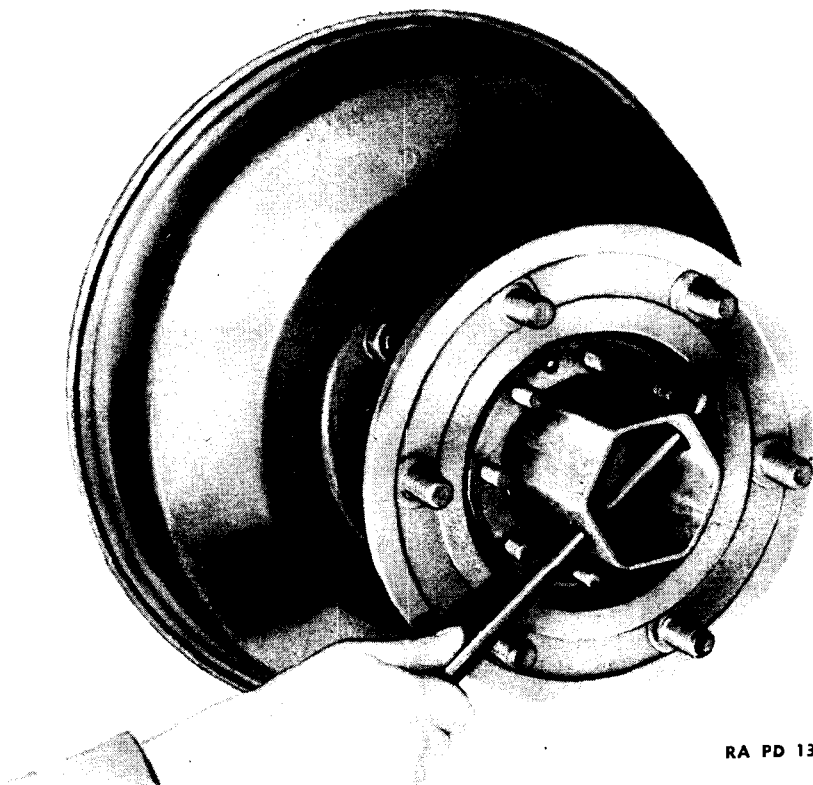

RA PD 13088

Figure 26 — Rear Wheel Bearing Adjustment

jack stands under frame just in front of spring front brackets to hold vehicle in this position.

c. Remove Spring Clips.

Bar, pinch
Hammer

Wrench, socket, $\frac{1}{8}$ -in.

Remove spring clip nuts and lock washers from each spring. Then knock off spring clip bottom plates and remove spring clips (U-bolts).

d. Disconnect Shock Absorber Connecting Links.

Wrench, socket, $\frac{3}{4}$ -in.

Remove nuts from connecting link bolts at axle plate.

e. Disconnect Spring at Rear Shackle.

Chisel
Drift
Hammer

Wrench, open-end, $\frac{9}{16}$ -in.

Wrench, socket, $\frac{9}{16}$ -in.

Remove nuts, lock washers, and cap screws clamping the shackle pins

REAR AXLE

in shackle assemblies. Loosen pins in shackles by forcing chisel into split, and then drive out pins. Lower rear end of springs to floor.

f. Disconnect Hydraulic Brake Hose at Bracket.

Wrench, open-end, $\frac{1}{2}$ -in.

Wrench, open-end, $\frac{1}{8}$ -in.

Wrench, open-end, $\frac{3}{4}$ -in.

Disconnect inverted flared tube nut that holds line assembly (master cylinder to rear brakes) to hose fitting at front of bracket. Then remove nut that holds hose assembly to bracket.

g. Disconnect Propeller Shaft at Pinion Shaft Companion Flange.

Wrench, open-end, $\frac{5}{8}$ -in.

Wrench, socket, $\frac{5}{8}$ -in.

Remove four nuts, lock washers and bolts that hold propeller shaft flange to pinion shaft companion flange and lower the propeller shaft.

h. Remove Wheel and Tire Assemblies.

Jack

Wrench, wheel stud nut

Place jack under differential housing and raise axle assembly until wheels are just off floor. Remove wheel stud nuts and pull off wheel and tire assemblies. NOTE: Removal of these assemblies can be made easier by slipping a greased board under the tires and just sliding assemblies off studs onto boards.

i. Remove Axle Assembly. Lower the jack that holds the axle assembly and pull out assembly.

57. INSTALLATION OF REAR AXLE ASSEMBLY.

Hammer

Wrench, open-end, $\frac{1}{8}$ -in.

Jack, hydraulic or hoist

Wrench, socket, $\frac{9}{16}$ -in.

Wrench, open-end, $\frac{1}{2}$ -in.

Wrench, socket, $\frac{5}{8}$ -in.

Wrench, open-end, $\frac{9}{16}$ -in.

Wrench, socket, $\frac{3}{4}$ -in.

Wrench, open-end, $\frac{5}{8}$ -in.

Wrench, socket, $\frac{1}{8}$ -in.

Wrench, open-end, $\frac{3}{4}$ -in.

Wrench, wheel stud nut

a. Place Axle Assembly in Position.

Jack, hydraulic

Place axle assembly on jack and raise it slightly above its normal running position under vehicle.

b. Install Wheel and Tire Assemblies.

Wrench, wheel stud nut

Set assemblies on wheel studs and replace stud nuts. Use greased board to facilitate assembly. Lower jack until axle assembly rests on tires and remove jack.

SCOUT CAR M3A1**c. Connect Springs at Rear Shackles.**

Hammer

Wrench, socket, $\frac{9}{16}$ -in.Wrench, open-end, $\frac{9}{16}$ -in.

Lift springs into position in shackles and install shackle pins. Install cap screws, lock washers and nuts, clamping shackle pins in shackles.

d. Connect Shock Absorbers to Axle.Wrench, socket, $\frac{3}{4}$ -in.

Insert shock absorber connecting link bolts through axle plates and install bolt nuts.

e. Connect Springs to Axles.Wrench, socket, $\frac{5}{8}$ -in.

Set spring clips (U-bolts) in position over axle housing and install spring bottom plates, lock washers and nuts.

f. Connect Propeller Shaft to Pinion Shaft Companion Flange.Wrench, open-end, $\frac{5}{8}$ -in.Wrench, socket, $\frac{5}{8}$ -in.

Hold propeller shaft flange and pinion shaft companion flange together and install holding bolts, lock washers and nuts.

g. Connect Hydraulic Brake Hose to Line (Master Cylinder to Rear Brakes) at Bracket.Wrench, open-end, $\frac{1}{2}$ -in.Wrench, open-end, $\frac{1}{8}$ -in.Wrench, open-end, $\frac{3}{4}$ -in.

Slip hose fitting through bracket and replace holding nut. Then connect brake line to hose by turning inverted flared tube nut onto hose fitting.

h. Lower Rear End of Vehicle.

Jack or hoist

Raise rear end of vehicle slightly, remove jack stands, and lower vehicle until its weight rests on springs. Remove jack (or hoist).

i. Bleed Brake Lines. All wheel cylinders must be bled as explained in paragraph 68.

Section XIII

BODY

	Paragraph
Body	58
Fenders	59
Windshield wipers	60

58. BODY (figs. 1, 2 and 3).

a. General. The vehicle body is made of $\frac{1}{4}$ -inch thick armor plate with the exception of the windshield plate and windshield porthole cover, which are $\frac{1}{2}$ -inch thick. The plates are held to the body framework by bolts and safety (elastic stop) nuts. The entire assembly is bolted to the chassis frame assembly. The floor plates are made of checkered aluminum and are bolted to the body framework.

b. Replacement of Components.

(1) The side doors, door shields, windshield plate, and hood plates, are all hinged and are dismounted by removing the bolts and safety nuts with which the hinges are bolted to these units.

(2) To detach the porthole covers on the windshield plate and side doors, remove the bolts and safety nuts that hold the brackets.

(3) To remove the covers of the ammunition racks, unscrew the bolts and nuts holding the angle bars by which the hinges are secured to the sides of the body. An air wrench is usually necessary to remove the safety nuts.

(4) The remaining body plates and the floor plates are removed by removing the bolts and nuts holding them in place.

c. Maintenance.

(1) Plates which are pierced by shells should be replaced with new plates. If this is not possible, temporary repairs can be made by bolting a section of plate over the shell hole. Do not attempt to weld plates together.

(2) Replace damaged springs on the radiator louver control lever ratchet rod and porthole bracket plunger, hinges, and any other worn or damaged parts.

59. FENDERS (figs. 27, 28 and 29).

a. Description. The front wheel fenders are made of pressed steel. The outside edges are turned over to form a bead for reinforcing purposes to prevent breaking or tearing (fig. 29). Each fender has two supports which are welded to the fenders at their outer edges (fig. 29). The front support is bolted to the frame and the rear support is bolted

SCOUT CAR M3A1

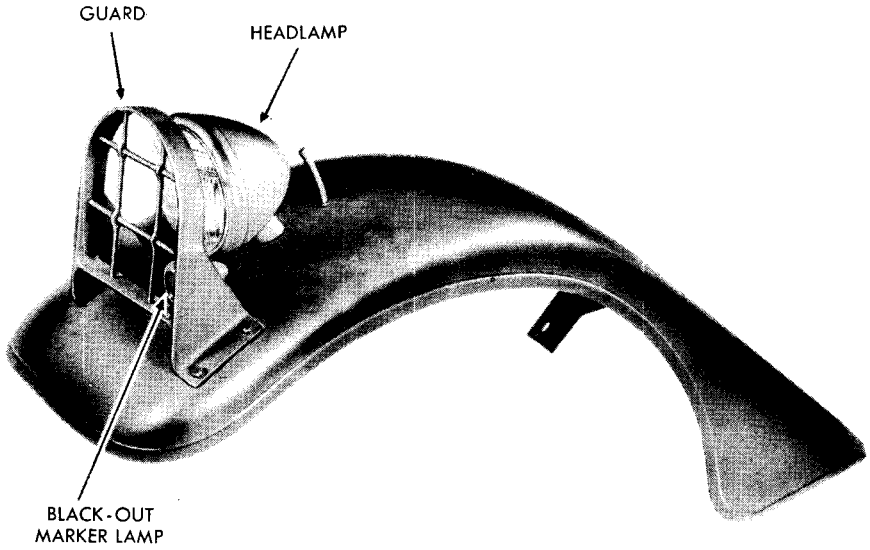

RA PD 13080

Figure 27 — Left Front Fender - Front View

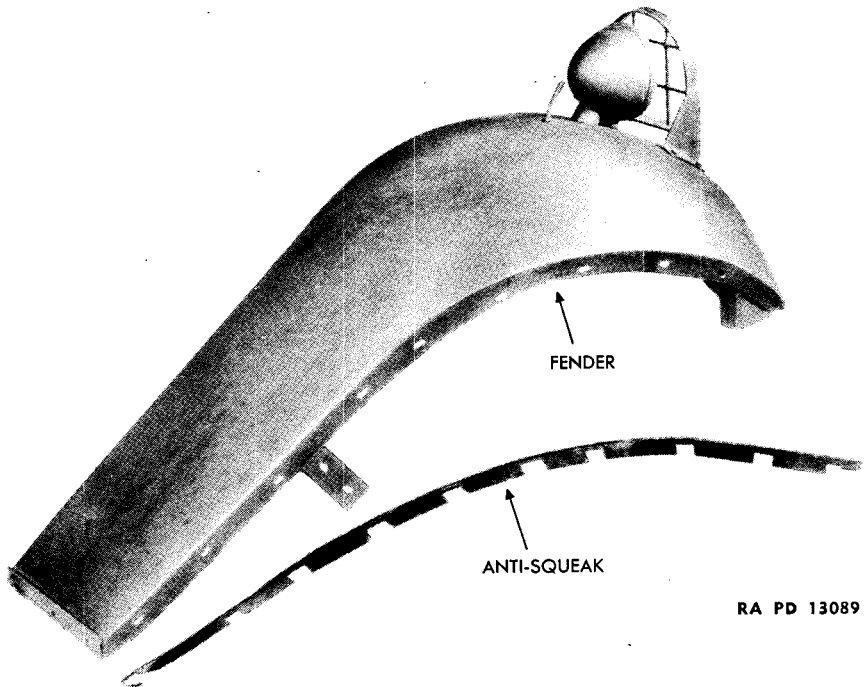

RA PD 13089

Figure 28 — Left Front Fender - Rear View

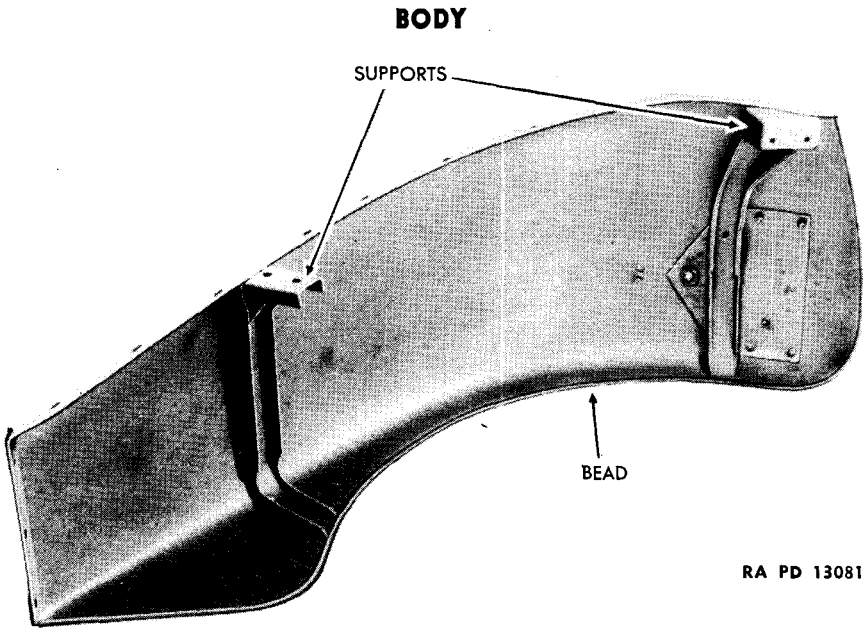

RA PD 13081

Figure 29 — Left Front Fender - Inside View

to the engine side armor plate. The fenders are also bolted to the engine side plates and running boards. The head lamps and guards are bolted to the top of the fenders at the front. The head lamp cables are disconnected by turning and extracting the terminal plugs at the rear of the lamps; the blackout marker lamp wires are detached from the connectors under the fenders and pulled through grommets in the fender below the lamps.

b. Removal.

Wrench, open-end, $\frac{7}{16}$ -in.

Wrench, socket, $\frac{7}{16}$ -in.

Wrench, open-end, $\frac{1}{2}$ -in.

Wrench, socket, $\frac{1}{2}$ -in.

Wrench, open-end, $\frac{9}{16}$ -in.

Wrench, socket, $\frac{9}{16}$ -in.

(1) DISCONNECT MARKER LAMP.

connectors under the fenders and pulled through grommets in the fender fender.

(2) DISCONNECT HEAD LAMP.

Disconnect head lamp wire at rear of lamp.

(3) REMOVE FENDERS.

Wrench, open-end, $\frac{7}{16}$ -in.

Wrench, socket, $\frac{7}{16}$ -in.

Wrench, open-end, $\frac{1}{2}$ -in.

Wrench, socket, $\frac{1}{2}$ -in.

Wrench, open-end, $\frac{9}{16}$ -in.

Wrench, socket, $\frac{9}{16}$ -in.

Remove two nuts, lock washers, bolts and spacers that hold each

SCOUT CAR M3A1

fender iron in place ($\frac{9}{16}$ -in. wrenches); nine nuts, lock washers and bolts that hold fender to armor plate ($\frac{1}{2}$ -in. wrenches); and three nuts, lock washers and bolts that hold rear of fender to running board support ($\frac{7}{16}$ -in. wrenches); lift off fender assembly and remove anti-squeak gasket.

c. Installation.

Wrench open-end, $\frac{7}{16}$ -in.

Wrench, socket, $\frac{7}{16}$ -in.

Wrench, open-end, $\frac{1}{2}$ -in.

Wrench, socket, $\frac{1}{2}$ -in.

Wrench, open-end, $\frac{9}{16}$ -in.

Wrench, socket, $\frac{9}{16}$ -in.

(1) INSTALL FENDER.

Wrench, open-end, $\frac{7}{16}$ -in.

Wrench, socket, $\frac{7}{16}$ -in.

Wrench, open-end, $\frac{1}{2}$ -in.

Wrench, socket, $\frac{1}{2}$ -in.

Wrench, open-end, $\frac{9}{16}$ -in.

Wrench, socket, $\frac{9}{16}$ -in.

Place anti-squeak gasket and fender in position and install bolts, lock washers and nuts to hold fenders to frame, armor plate and running board support.

(2) CONNECT HEAD LAMPS. Reconnect wire at rear of lamp.

(3) CONNECT MARKER LAMP. Reconnect blackout marker lamp wire under fender.

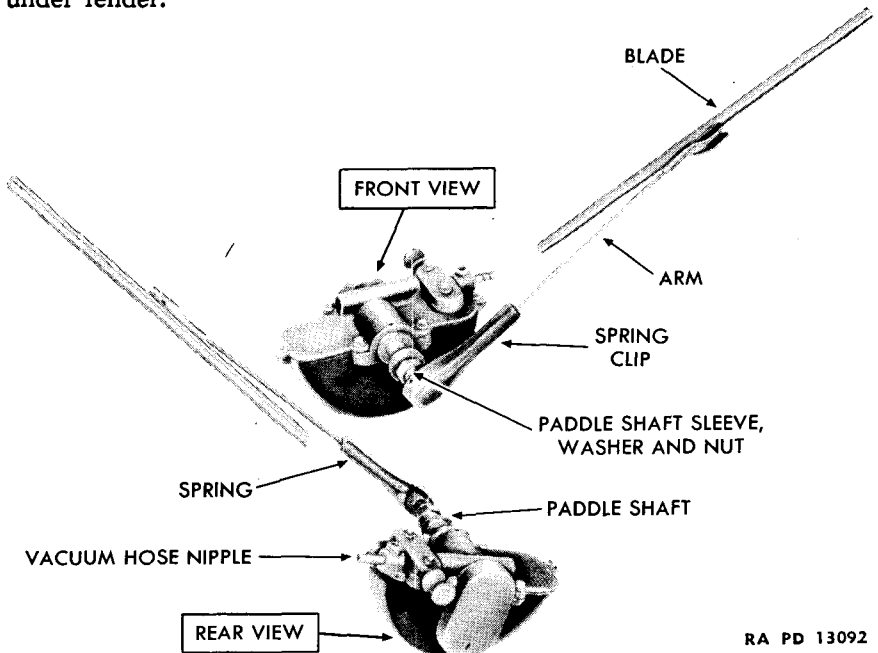

RA PD 13092

Figure 30 — Windshield Wiper Assembly

BODY

60. WINDSHIELD WIPERS.

a. Description. The windshield wipers are vacuum type, and are mounted on the left- and right-hand side of the windshield frame over the instrument panel.

b. Trouble Shooting.

Symptom and Probable Cause

Probable Remedy

(1) WIPER MOVES VERY SLOWLY.

Poor vacuum.

Check lines for leaks and replace hose or tubing, if necessary.

Check vacuum pump for leaks and tighten diaphragm screws.

Replace vacuum pump diaphragm, if necessary.

Clogged exhaust ports.

Replace wiper assembly.

Lack of lubricant.

Replace wiper assembly.

(2) WIPER MOVES IN ONE DIRECTION ONLY.

One set of ports is clogged.

Replace wiper assembly.

Lack of lubricant.

Replace wiper assembly.

(3) WIPER WILL NOT MOVE.

Hose or pipe assembly split.

Check and replace damaged hose or pipe.

Clogged ports.

Replace assembly.

Paddle frozen in one spot.

Replace wiper assembly.

(4) WIPER STREAKING WINDSHIELD.

Worn or damaged wiper blade. Replace blade assembly.

c. Removal.

Wrench, open-end, $\frac{7}{16}$ -in.

(1) REMOVE BLADE AND ARM ASSEMBLY.

Wrench, open-end, $\frac{7}{16}$ -in.

Lift blade arm and pull off spring clip. Then pull arm out of paddle shaft hole.

(2) REMOVE MOTOR ASSEMBLY.

Wrench, open-end, $\frac{7}{16}$ -in.

Detach vacuum hose from nipple. Then remove paddle shaft sleeve nut and washer and dismount motor assembly from top of instrument panel.

d. Installation.

Wrench, open-end, $\frac{7}{16}$ -in.

SCOUT CAR M3A1

(1) ATTACH MOTOR ASSEMBLY TO WINDSHIELD.

Wrench, open-end, $\frac{7}{16}$ -in.

Push paddle shaft through windshield frame, and fasten assembly by replacing shaft sleeve washer and nut.

(2) ATTACH WIPER ARM TO PADDLE SHAFT. Push hooked end of arm into paddle shaft hole. Then set narrow end of arm spring clip over spring, compress spring, and push wide end of clip into slot cut around end of paddle shaft.

(3) REPLACE WIPER BLADE ASSEMBLY. Hook blade assembly into wiper arm slot.

Section XIV

BRAKE SYSTEMS

	Paragraph
General description	61
Trouble shooting	62
Master cylinder	63
Vacuum power booster.....	64
Service brake shoes.....	65
Service brake pedal linkage.....	66
Service brake adjustments.....	67
Bleeding the lines.....	68
Drive shaft brake.....	69

61. GENERAL DESCRIPTION (fig. 31).

The service brakes operate on all four wheels. They are actuated under the control of a hydraulic system which comprises the pedal, linkage, a master cylinder, a vacuum power booster, an air cleaner and check valve for the booster brake lines, wheel cylinders and shoes. The booster check valve is attached to the dash on the engine side and is connected by tubing to the rear of the booster. A disk-type mechanical brake for parking only is mounted on a companion flange of the propeller shaft to the rear of the transfer case.

62. TROUBLE SHOOTING.

Symptom and Probable Cause

Probable Remedy

a. Pedal Striking Floorboard.

Lining wear.

Readjust upper ends of shoes only; do not turn anchor pins.

Incorrectly adjusted brake shoes.

Readjust shoes at both ends.

Improper adjustment of master cylinder clevis on master cylinder brake rod.

Adjust (par. 67).

Leaks.

Check system and repair.

Air in system (indicated by "spongy" pedal action).

Bleed lines (par. 68).

Insufficient brake fluid.

Refill master cylinder.

b. All Brakes Drag.

Insufficient brake shoe clearance.

Reset shoes.

Mineral oil in system.

System will have to be flushed with alcohol and serviced by ordnance personnel to replace cylinder cups, etc.

SCOUT CAR M3A1

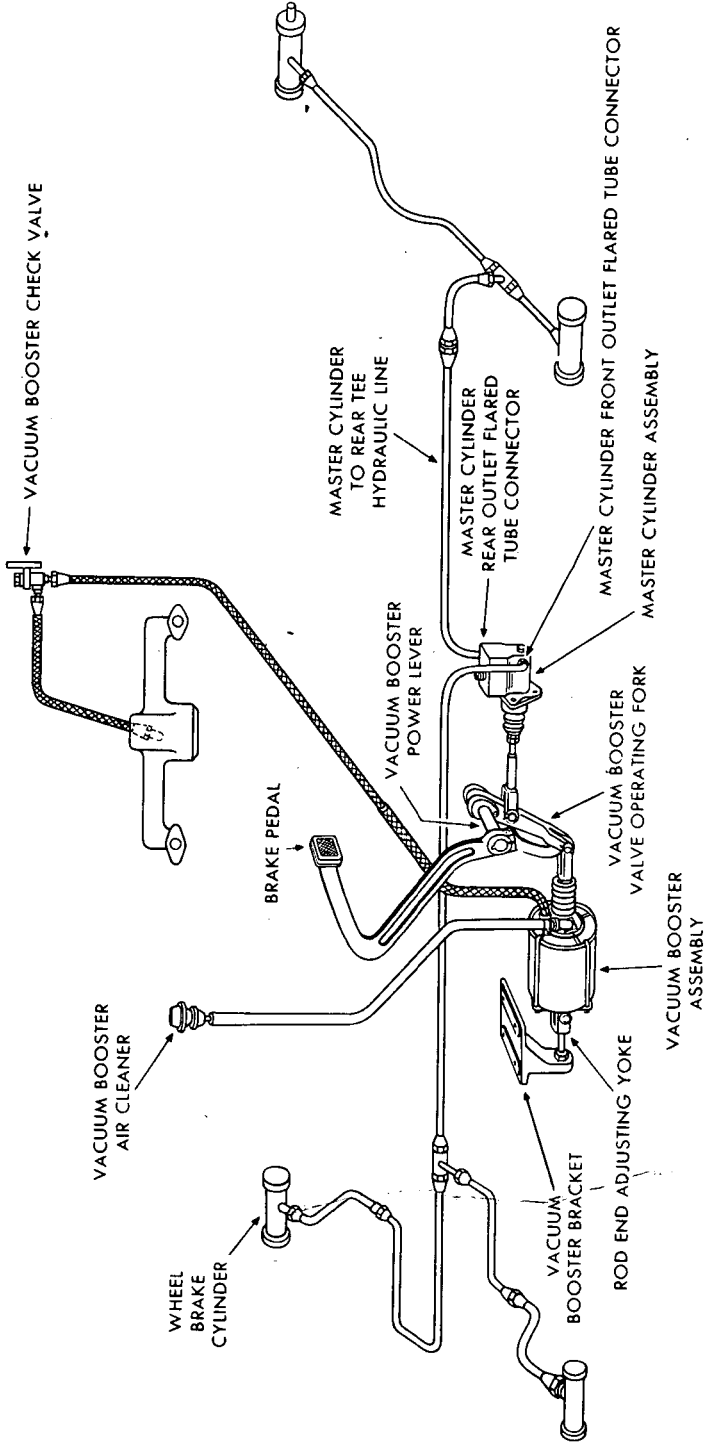

RA PD 13033

Figure 31 — Hydraulic Brake System

BRAKE SYSTEMS

Symptom and Probable Cause	Probable Remedy
Improper adjustment of master cylinder clevis on the master cylinder brake rod.	Adjust (par. 67).
Weak return spring.	Replace.
c. One Brake Drags.	
Weak or damaged brake shoes return spring.	Replace.
Shoe binding on anchor pin.	Free and lubricate.
Insufficient brake shoe clearance.	Reset.
Loose wheel bearings.	Readjust bearing to position, drum correctly around shoes.
Grease on linings.	Check grease seals and overlubrication, replace shoe assembly.
Tubing obstruction.	Replace tubing.
d. Pulling to One Side.	
Grease on linings.	Check grease seals and replace if defective, check for overlubrication, replace shoe assembly.
Shoe improperly adjusted.	Readjust accurately and check with feeler gage.
Loose backing plates.	Tighten plates and readjust brake shoes.
Different linings.	Replace those that are different with shoe assemblies having linings of the same make.
Worn linings.	Replace with shoe assembly.
Scored drums.	Replace, or have resurfaced.
e. Excessive Pedal Pressure Required for Stopping.	
Brake shoes incorrectly adjusted.	Readjust.
Improper linings.	Replace shoe assembly.
Partial contact between lining and drum.	Dress down high spots on linings, or adjust shoes at their ends.
f. Noisy Brakes.	
Bent or distorted backing plate.	Straighten or replace with new plate.
Bent or distorted brake shoes.	Replace with new shoe assembly.
Dirt in linings.	Remove any imbedded particles.
Loose lining rivets.	Replace shoe assembly.
Drums distorted.	Replace, or have reground.

BRAKE SYSTEMS

g. Drive Shaft Brake Does Not Hold When Lever Is Pulled Back.

Symptom and Probable Cause

Probable Remedy

Linings and brake shoes improperly mounted.

Inspect brake shoes and connections, and adjust or replace parts as required.

Linings worn out.

Replace shoe assemblies.

h. Drive Shaft Brake Lever Will Not Stay in ON Position.

Ratchet worn or broken.

Replace with new ratchet.

Ratchet dog worn or broken.

Replace with new dog.

63. MASTER CYLINDER (fig. 32).

a. Description. The master cylinder stores the fluid to actuate the service brakes under the control of the brake pedal.

b. Servicing. The level of the fluid in the master cylinder supply tank should be inspected at least once a month. The proper level of the fluid is $\frac{3}{4}$ of an inch below the top of the tank. There should be practically no loss of fluid in the operation of the brakes. Any noticeable loss indicates a leak in the system which should be located and stopped. If the tank becomes more than half empty, air may be drawn into the system when the brake is released. In such a case, filling the tank to the proper level is not enough. The system will have to be bled at each wheel cylinder to remove the air entirely (par. 68). The master cylinder assembly should be removed and replaced as a unit when any part of it is damaged.

c. Removal (fig. 32).

Pliers

Wrench, open-end, $\frac{7}{16}$ -in.

Screwdriver

Wrench, open-end, $\frac{1}{2}$ -in.

Remove the cotter pin and clevis pin from the cylinder piston rod at the brake pedal power lever. Disconnect hydraulic lines at the cylinder by removing the front and rear line flared tube nuts ($\frac{1}{2}$ -in. open-end wrench) from their fittings. Disconnect stop light switch wires. Remove the three nuts, lock washers, and cap screws ($\frac{7}{16}$ -in. wrench) that attach the master cylinder to the bracket and remove the complete assembly. Drain reservoir through filler plug and pump fluid out of the cylinder by pushing on the piston rod. Remove the pedal to master cylinder rod from the master cylinder assembly.

d. Installation.

Plier

Wrench, open-end, $\frac{7}{16}$ -in.

Screwdriver

Wrench, open-end, $\frac{1}{2}$ -in.

Connect pedal to master cylinder rod to the master cylinder assembly and install the cylinder in place on the bracket with cap screws, lock washers and nuts ($\frac{7}{16}$ -in. open-end wrench). Connect the stop light

SCOUT CAR M3A1

switch wires. Connect the front and rear hydraulic lines to the cylinder by means of the flared tube nuts ($\frac{1}{2}$ -in. open-end wrench). Connect the cylinder piston rod at the brake pedal power lever by installing the clevis pin and cotter pin. Refill the cylinder with brake fluid. Bleed the lines. Refer to paragraph 67 for adjustment procedure.

64. VACUUM POWER BOOSTER (fig. 33).

a. **Description.** The vacuum power unit acts as a power or booster complement for the brake pedal, to actuate the master cylinder and reduce the amount of physical effort required to apply the brakes. The booster is connected through the check valve to the engine intake manifold (fig. 34).

b. **Testing.** Remove the pipe plug at the front of the booster and connect a vacuum gage. Start the engine and note the gage reading, which should be a vacuum of 17 to 20 inches; stop the engine and note if the vacuum is retained for a reasonable length of time. If the gage shows a rapid decrease (more than 10 in. in 10 sec.), a leak is indicated in the booster which may often be corrected by a thorough lubrication of the unit. (Refer to lubrication guide, fig. 13.) When the booster becomes

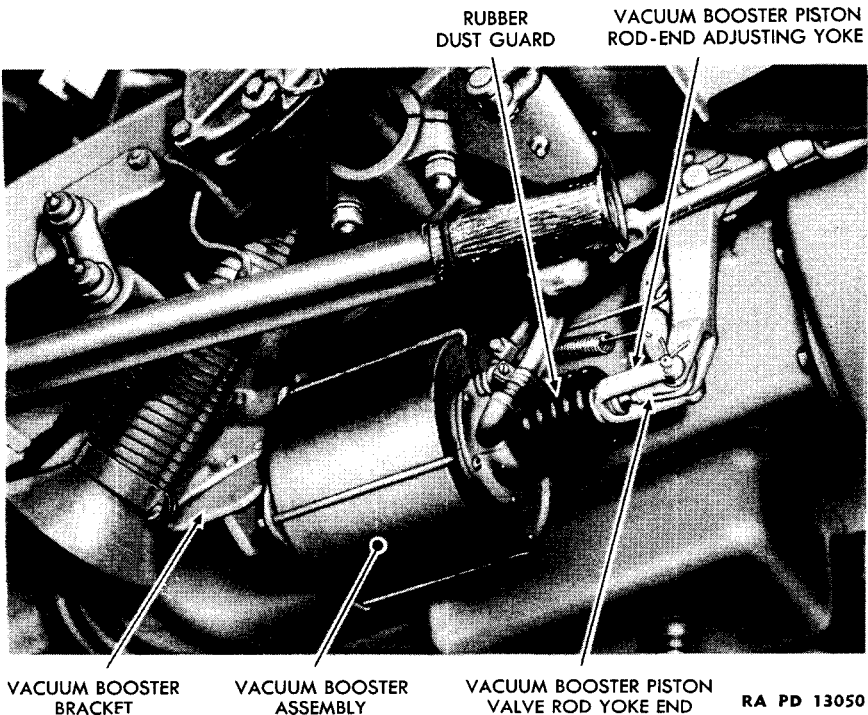
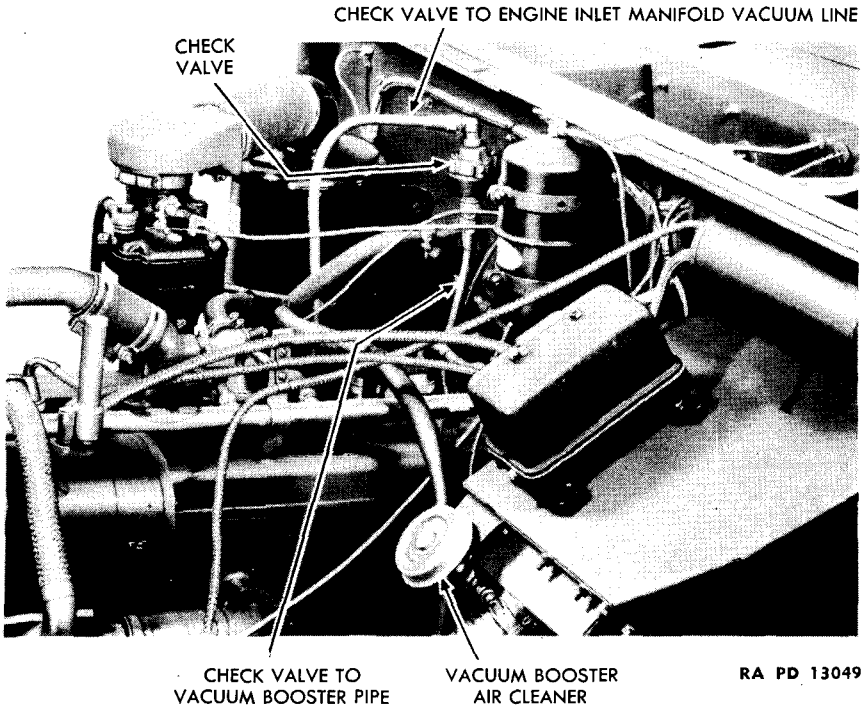

Figure 33 — Vacuum Booster Installed, Side View

BRAKE SYSTEMS



RA PD 13049

Figure 34 — Brake Booster Accessories - (Gasoline Engine)

damaged in any manner, it must be removed and replaced as a complete unit.

c. Removal.

Pliers

Screwdriver

Disconnect the vacuum line at the booster by loosening the screw in the clamp holding the hose to the booster and remove the hose from the nipple (fig. 33). Disconnect the air cleaner line by loosening the screws in the clamp which holds the hose to the booster and remove the hose from the nipple. Remove the cotter pin and rod-end pin at the bracket end of the cylinder and lower the end of the cylinder (fig. 35). Remove the cotter pin and the rod-end pin at the piston rod yoke end. Remove the yokes from both ends of the booster assembly. Remove the booster assembly (fig. 33).

d. Installation.

Pliers

Screwdriver

Connect the yokes to the ends of the booster assembly. Place the assembly in position and install the rod-end pin and cotter pin at the piston rod yoke end (fig. 33). Install the cotter pin and rod-end pin at the bracket end (fig. 35). Connect the air cleaner line by installing it on the nipple

SCOUT CAR M3A1



VACUUM POWER BOOSTER

RA PD 13090

Figure 35 — Disconnecting Vacuum Booster

of the booster and tightening the clamp (fig. 33). Connect the vacuum line by installing it on the nipple of the booster and tightening the clamp. Check the adjustment (par. 67).

e. Air Cleaner (fig. 34).

Screwdriver

Wrench, open-end, $\frac{3}{8}$ -in.

(1) REMOVAL.

Screwdriver

Wrench, open-end, $\frac{3}{8}$ -in.

Remove two nuts, lock washers and screws that attach the adapter to the bracket. Loosen the hose connection, slip off the hose and remove the air cleaner.

(2) MAINTENANCE. The air cleaner should be cleaned at the 1,000 mile inspection. Remove the filter element, wash it thoroughly in SOLVENT, dry-cleaning, dry, and saturate it with OIL, engine, SAE 10. Install the filter element in the air cleaner body.

(3) INSTALLATION.

Screwdriver

Wrench, open-end, $\frac{3}{8}$ -in.

Place adapter on bracket and fasten with the two nuts, lock washers and screws. Connect the hose and tighten hose connection.

BRAKE SYSTEMS

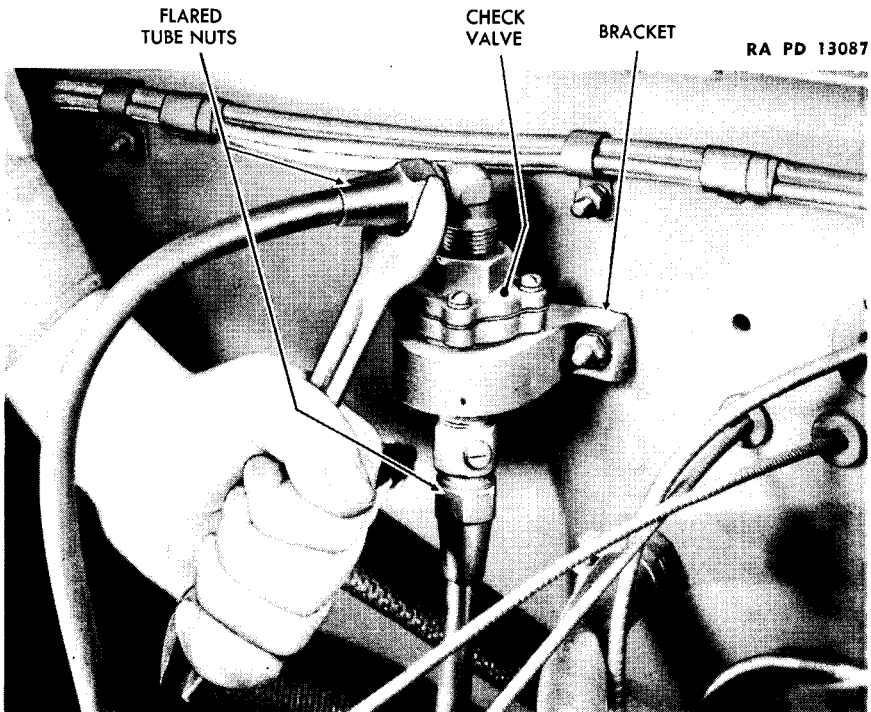

**Figure 36 — Vacuum Line Removal from Check Valve -
(Gasoline Engine)**

f. Check Valve.

(1) **DESCRIPTION.** A check valve, mounted on the dash at the right side of the engine compartment (fig. 34) is provided in the vacuum line of the brake booster between the engine intake manifold and the booster vacuum outlet. The function of the check valve is to seal the vacuum in the booster when the engine stalls.

(2) **REMOVAL.**

Wrench, open-end, $\frac{7}{16}$ -in.

Wrench, open-end, $\frac{7}{8}$ -in.

Loosen and remove two flared tube nuts from check valve inlet and outlet fittings ($\frac{7}{8}$ -in. open-end wrench). Loosen and remove two bolts, lock washers and nuts from bracket mounting check valve to dash ($\frac{7}{16}$ -in. open-end wrench), and remove valve (fig. 36).

(3) **INSTALLATION.**

Wrench, open-end, $\frac{7}{16}$ -in.

Wrench, open-end, $\frac{7}{8}$ -in.

Place the check valve in position on the bracket and mount the bracket to the dash with two bolts, lock washers and nuts ($\frac{7}{16}$ -in. open-end

SCOUT CAR M3A1

wrench). Install the lines at the inlet and outlet fittings by means of the two flared tube nuts ($\frac{7}{8}$ -in. open-end wrench) (fig. 36).

g. Vacuum Pump Air Cleaner (Diesel Engine Only) (figs. 37 and 38). This air cleaner is used to filter the air going to the vacuum pump. It can be removed at regular intervals for cleaning by removing the hose connection and unscrewing the assembly from the check valve elbow.

65. SERVICE BRAKE SHOES (fig. 39).

a. Description. The service brakes proper consist of a combination of two internal expanding shoes, a brake drum, and a wheel cylinder for each wheel. The shoes, lined with molded brake lining, are supported at the lower end by eccentric anchor pins and connected at the top to the actuating cylinder.

b. Removal.

Clamp, cylinder

Wrench, wheel stud nut

Jack

Jack up the vehicle until the wheel is free. Block the brake pedal in the released position to prevent any possibility of movement. Remove

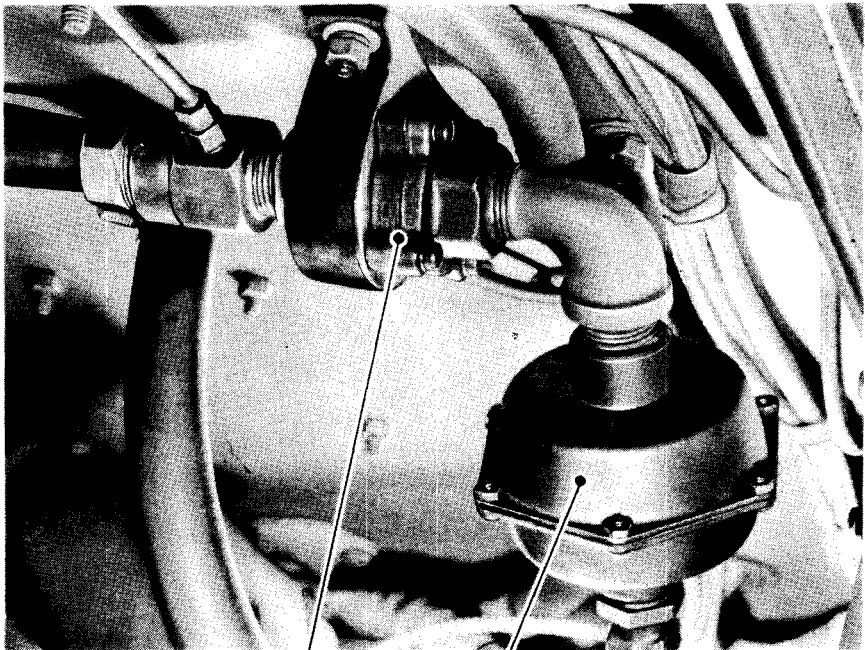

CHECK
VALVE

AIR
CLEANER

RA PD 13071

Figure 37 — Brake Vacuum Booster Air Cleaner and Check Valve (Diesel)

BRAKE SYSTEMS

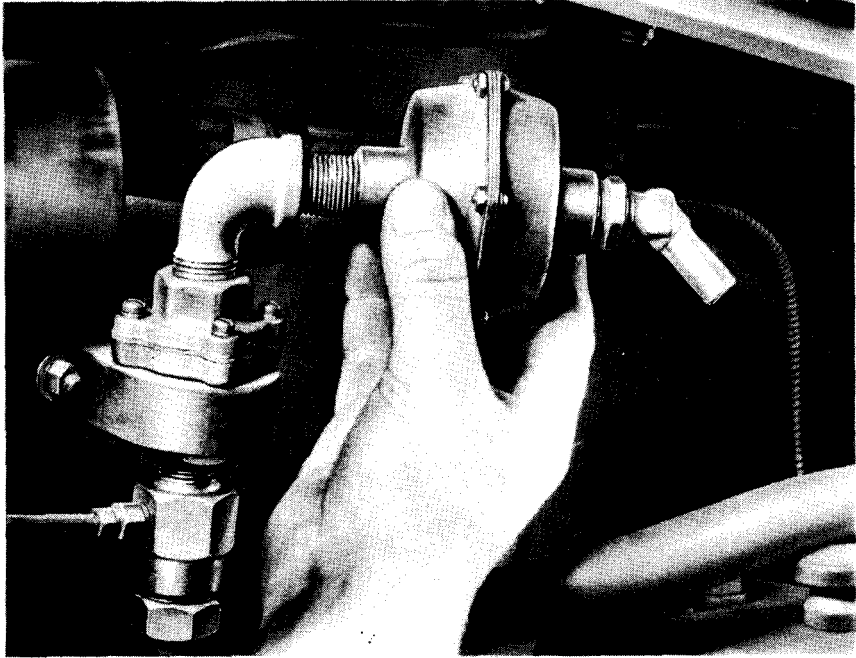

RA PD 13070

Figure 38 — Removing Brake Air Filter - (Diesel)

the wheel and brake drum assembly, using a wheel stud nut wrench. Remove the brake shoe spring (fig. 39). Install a wheel brake cylinder clamp to retain the pistons in place, as shown in figure 40. Mark the shoes so that they can be replaced to their original positions, if relined. Remove the guide and anchor pin washers (fig. 39). Lift the shoe off the anchor pin, swinging it outward to clear the side pins, and withdraw link from cylinder position at upper end.

c. Installation.

Clamp, cylinder

Wrench, wheel stud nut

Jack

Place the shoe on the anchor pin. Install connecting link at upper end of shoe. Install the guide and anchor pin washers. With the clamp holding the pistons in place, install the brake shoe spring, then remove the clamp. Reinstall the wheel and brake drum assembly in position.

66. SERVICE BRAKE PEDAL LINKAGE (fig. 32).

The clamping bolts for the brake pedal and its associated linkage must be kept tight; loose leverage will adversely affect the operation of the brakes. Replace return spring when it is weak or broken. Renew worn

SCOUT CAR M3A1

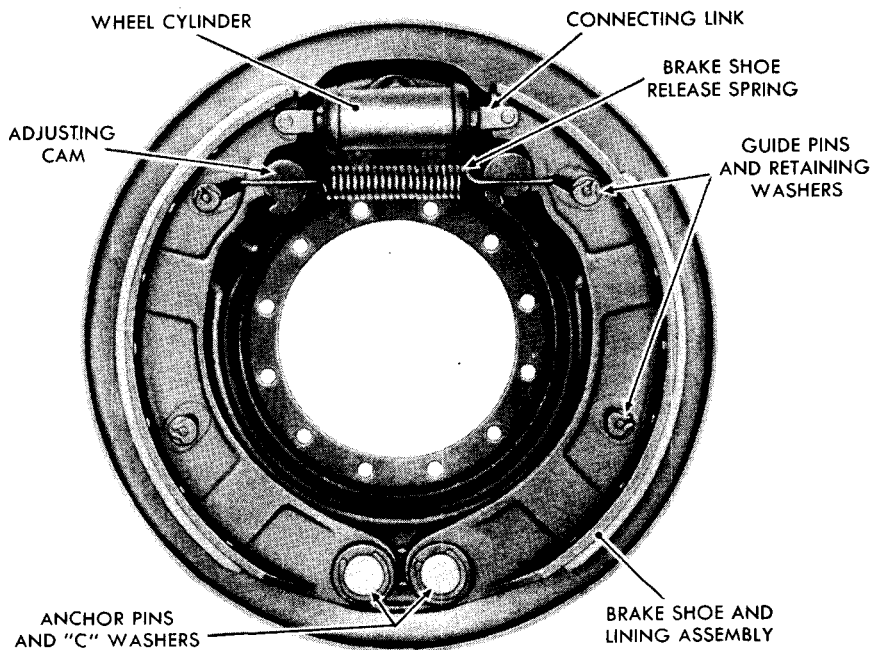

RA PD 13180

Figure 39 — Front Wheel Brake Cylinder and Shoes

clevis pins connecting brake levers to master cylinder piston rod, and power cylinder piston and valve rod.

67. SERVICE BRAKE ADJUSTMENTS.

Brake adjustments are necessary when brake linings have become worn and excessive pedal travel exists, and should be made before it is necessary to "pump" the brake pedal several times to secure proper braking effort. Before attempting to make adjustments of brakes, it is important to see that all wheel bearings are properly adjusted.

a. **Pedal Linkage** (fig. 32). Improper adjustments will affect the application and operation of the brakes, especially where the vacuum booster is concerned. The valve operating fork is attached to the brake pedal shaft by two cap screws and a clamp with an oversize hole at the lower cap screw to facilitate adjustment.

(1) Loosen valve operating fork anchorage screws and remove master cylinder and power booster piston rod clevis pins (fig. 32).

(2) Be sure that the leverage system is clean, in correct alinement, and not binding.

(3) Block brake pedal in release position.

(4) Adjust master cylinder clevis to permit about $\frac{1}{32}$ -inch lost motion in the master cylinder piston rod; insert clevis pin and cotter pin (fig. 32).

BRAKE SYSTEMS

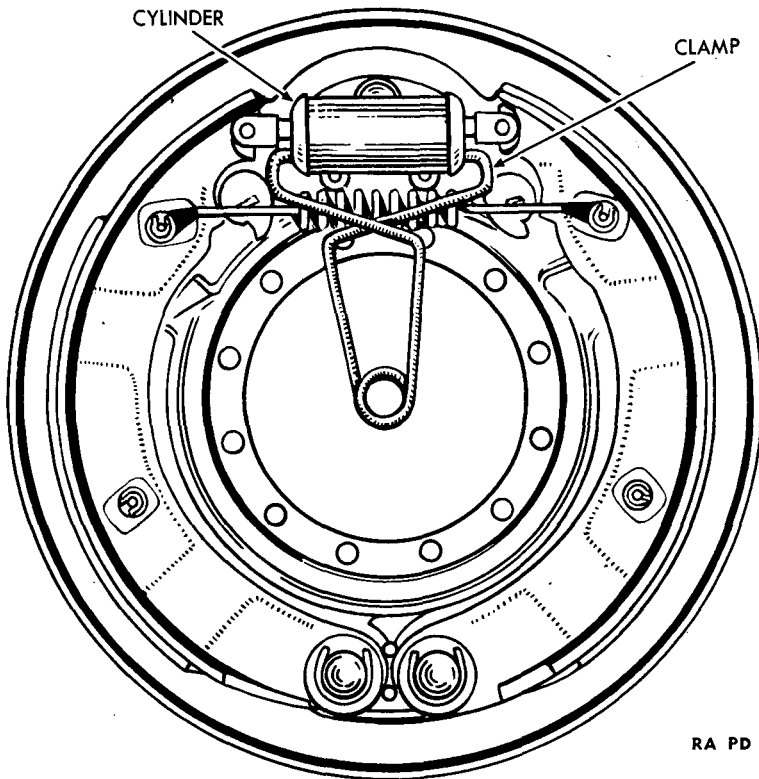

RA PD 13181

Figure 40 — Clamping Wheel Brake Cylinder

(5) Push booster piston rod until the piston bottoms. Aline piston rod clevis with power lever eye by adjusting cylinder position at the mounting end. Never attempt to adjust piston rod clevis, as this affects valve positioning which is correctly set at the time of factory assembly.

(6) Check to see that the piston rod clevis pin is against the rear side wall of the bushing; then tighten adjustment screws, exercising care not to disturb the valve position. Be sure the valve operating fork is central and square on the bushing to avoid binding.

(7) If adjustment has been made correctly, the valve rod will move inward about $\frac{1}{4}$ inch when the brake pedal is moved by hand, with the engine running, before any movement of the power lever occurs.

(8) Check for insertion of cotter pins, tightness of lock nuts and cap screws.

b. Lining Wear (fig. 39). To take up wear on the lining, only a minor adjustment is necessary.

(1) Raise the vehicle until the wheels are free.

SCOUT CAR M3A1

(2) Adjust one shoe at a time by turning the adjusting cam (fig. 39) until the lining is pressed firmly against the drum and the wheel is locked.

(3) Back off the adjustment slightly until the wheel rotates freely without drag.

(4) Adjust all eight brake shoes in this manner. The cams are automatically locked in position by friction springs.

c. After Relining. Major adjustments are not ordinarily necessary except after relining brakes, grinding drums, or in case of displaced anchor pins.

(1) Leave wheels and drums in place and raise the vehicle.

(2) Remove inspection hole covers ($\frac{9}{16}$ -in. wrench) and insert thickness gages through the holes in the drum.

(3) Loosen the anchor pin locking nut ($\frac{15}{16}$ -in. wrench) at the rear of the backing plate and turn the eccentric anchor pin at the "heel" or lower end of the shoe. At a distance of approximately one inch from the end of the lining near this pin, the clearance between the lining and drum should be 0.005 inch.

(4) Tighten the holding nut and recheck the clearance.

(5) Rotate the wheel and drum assembly until the inspection hole is at the "toe" or upper end of the shoe.

(6) Insert a thickness gage between the lining and drum, approximately one inch from the upper end of the lining, and turn the adjusting arm bolt until the clearance is 0.010 inch.

(7) Replace inspection hole covers.

(8) Tighten bolts and check pedal travel after the adjustments.

d. Brake Lines. Any leaks in the metal tubing or flexible lines will impair the effectiveness of the brakes. All couplings, connections and fittings must be tightened by screwing up the nuts on the hose and tubing. Tubing should be mounted to eliminate chafing against metal parts which will cause fracture.

68. BLEEDING THE LINES.

a. Operation. Bleeding the lines consists of displacing all the air, which may have accumulated in the system, by means of forcing the fluid through the lines until it flows from the bleeder valve on each of the four wheel cylinders in a solid stream. This procedure is necessary only when some part of the hydraulic mechanism has been disconnected, or when the fluid in the supply tank has become too low. Only approved brake fluid should be used; *never use oil.*

BRAKE SYSTEMS

b. Procedure.

(1) Remove the two screws that hold the floor plate in the driver's compartment over the filler plug and remove the plate.

(2) Unscrew the filler plug on top of master cylinder supply tank (fig. 32).

(3) Using a Wagner Lockheed Fluid Filler, insert the nozzle into the filler hole.

(4) Remove the bleeder valve cap screw and lock washer from a wheel cylinder and screw the nipple in place at the end of a rubber drain tube. Slide the bleeder valve wrench over the rubber tube and place the free end of the tube below the level of the brake fluid in a clean glass container comparable to a one-pint jar. Open the valve $\frac{3}{4}$ of a turn.

(5) Depress the foot pedal slowly by hand, allowing the return spring to return the pedal to its release position. A number of strokes of the pedal will be required to bleed each wheel cylinder until fluid issues from the end of the tube in a solid stream without air bubbles. As each wheel cylinder is bled, the bleeder valve is shut off tightly with the wrench; the bleeder tube is removed and the cap screw with the lock washer replaced. **NOTE:** After one cylinder has been bled, do not again depress the brake pedal

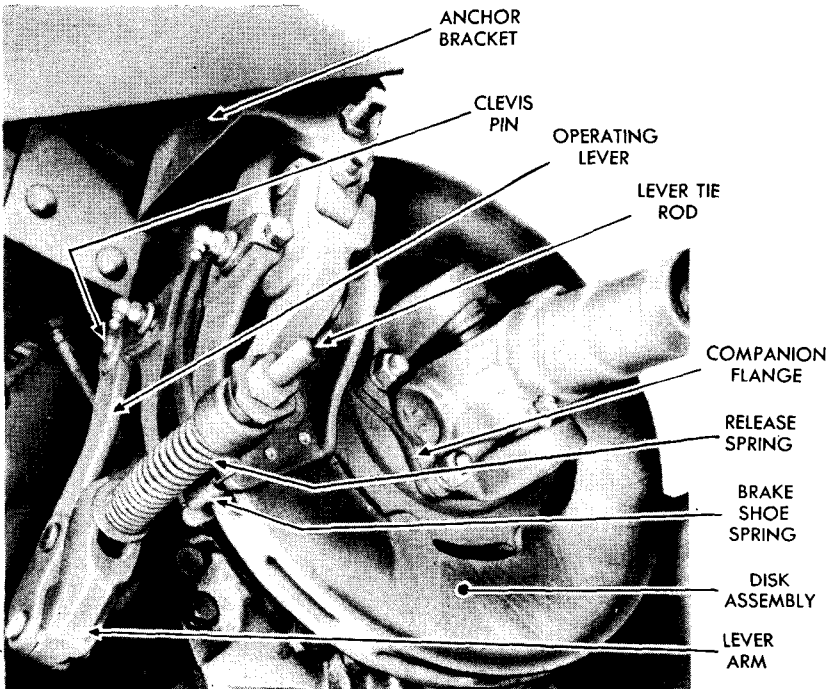

RA PD 1305

Figure 41 — Hand Brake, Installed - Bottom View

SCOUT CAR M3A1

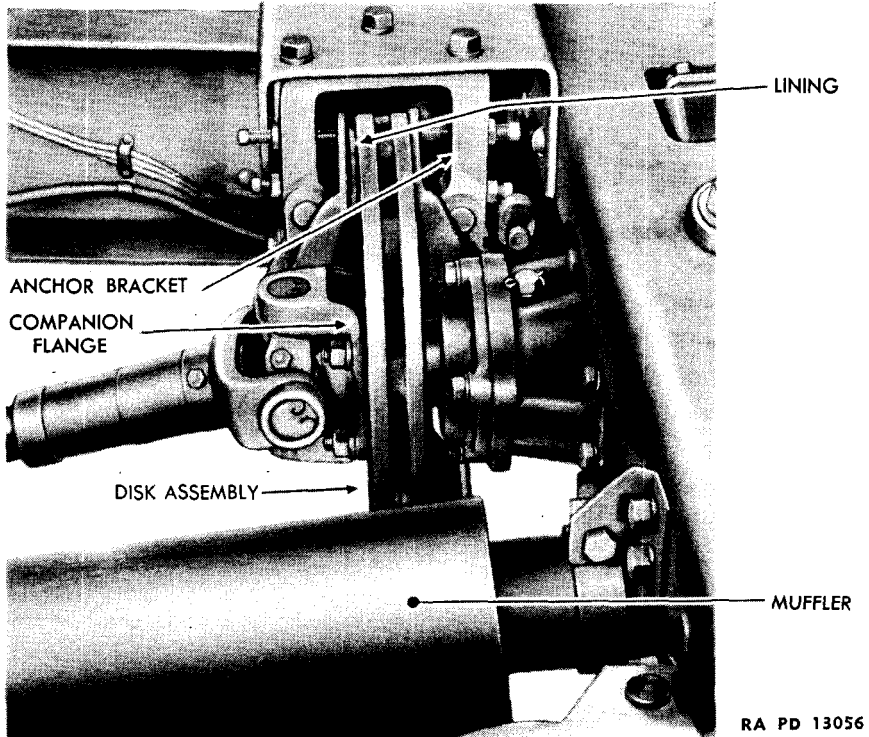

Figure 42 — Hand Brake, Installed - Top View

until the valve of the next cylinder is opened, since air may be forced from a line yet to be bled into a line on which this operation has been completed.

(6) Follow this procedure for all brake cylinders, taking the one farthest from the master cylinder first. When the bleeding has been completed, remove the fluid refiller from the supply tank and install the filler plug.

69. DRIVE SHAFT BRAKE.

a. **Description** (figs. 41 and 42). The drive shaft brake incorporates two shoes which operate on a disk that is mounted on a companion flange of the propeller shaft to the rear of the transfer case. The brake shoes are lined with a heavy-duty molded lining. This brake is to be applied after the vehicle has been brought to a stop and not when the vehicle is in motion.

b. **Adjustment.** Brake shoes must normally be concentric with and not touch the disk when the brake is in the released position. When the linings wear so that the brake will not hold, adjustment should be made as follows:

- | | |
|--|---------------------------------------|
| Pliers | Wrench, open-end, $\frac{3}{8}$ -in. |
| Shims, $\frac{1}{32}$ -in., two, or feeler gages | Wrench, open-end, $1\frac{1}{4}$ -in. |

BRAKE SYSTEMS

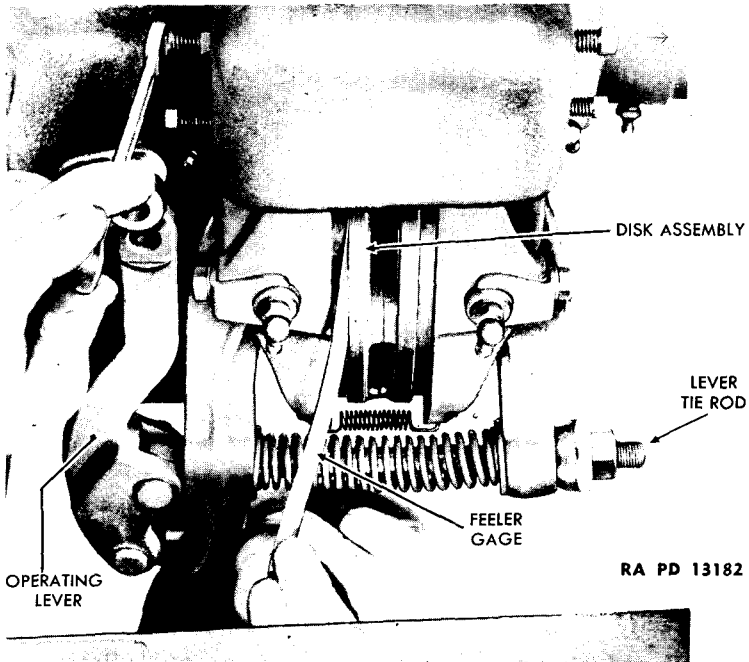

Figure 43 — Drive Shaft Brake Shoe Adjustment

(1) Release the hand brake lever fully and disconnect the hand lever pull rod clevis pin. Tighten the operating lever tie rod adjusting nut ($1\frac{1}{4}$ -in. wrench) so that the lever arm release spring on the tie rod will draw the operating lever firmly against the front brake lever arm (fig. 41).

(2) Insr a $\frac{1}{32}$ -inch shim or feeler gage between the front shoe lining and disk (fig. 43). Adjust the hand lever pull rod to maintain this clearance and replace the clevis pin.

(3) Adjust the rear shoe for the same clearance, using a $\frac{1}{32}$ -inch shim or feeler gage, with the disk (fig. 44), and turn the nut on the rear end of the tie rod to keep this spacing.

(4) Make sure that the spring connecting the lower ends of the brake shoes is in place, and adjust the top screws at the front and rear of the anchor bracket to make shoes and linkage parallel to the disk ($\frac{3}{8}$ -in. open-end wrench).

(5) Remove the shims.

e. Removal of Assembly.

- Pliers
- Wrench, box, $\frac{5}{8}$ -in.
- Wrench, open-end, $\frac{3}{8}$ -in.
- Wrench, open-end, $\frac{5}{8}$ -in.

- Wrench, open-end, $1\frac{3}{16}$ -in.
- Wrench, open-end, $1\frac{1}{4}$ -in.
- Wrench, socket, $\frac{1}{2}$ -in.

SCOUT CAR M3A1

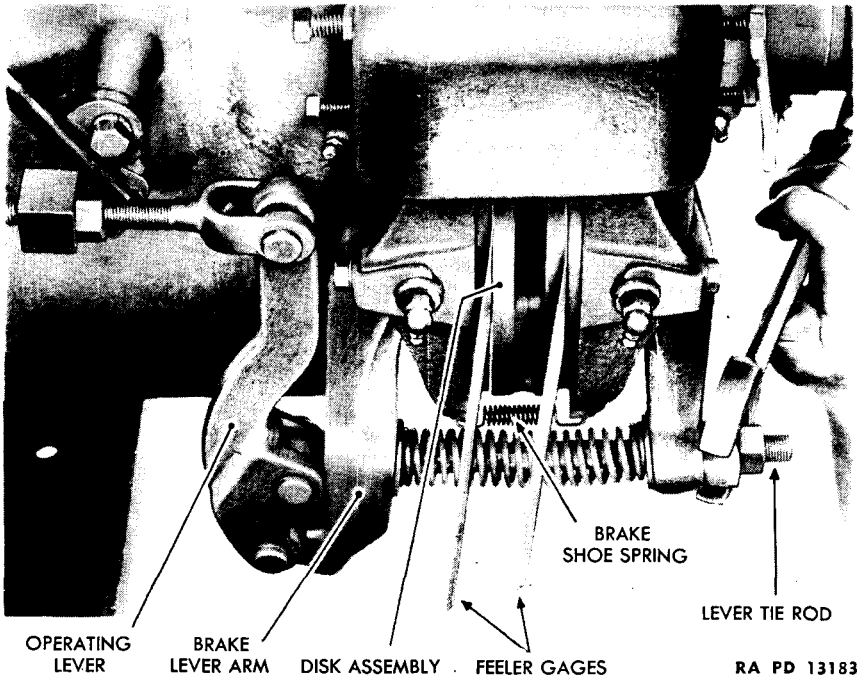

RA PD 13183

Figure 44 — Drive Shaft Brake Shoe Adjustment

(1) DISCONNECT PULL ROD AT OPERATING LEVER.

Pliers

Pull out cotter pin and remove clevis pin rod and pin.

(2) REMOVE BRAKE ASSEMBLY.

Pliers

Wrench, open-end, 13/16-in.

Wrench, open-end, 3/8-in.

Wrench, open-end, 1 1/4-in.

Remove shoe spring. Loosen shoe adjusting set screws (3/8-in. open-end wrench) and tie rod lock nut and adjusting nut (1 1/4-in. open-end wrench). Then remove three cap screws and lock washers (1 3/16-in. open-end wrench) that hold anchor bracket to frame bracket and lower brake assembly (fig. 41).

(3) REMOVE DISK ASSEMBLY.

Wrench, box, 5/8-in.

Wrench, open-end, 5/8-in.

Remove four nuts, lock washers and bolts that hold rear propeller shaft flange and brake disk to companion flange to rear of transfer case (fig. 42). Lower propeller shaft and disk assembly to floor.

(4) REMOVE OPERATING LEVER TIE ROD.

Pliers

Wrench, open-end, 1 1/4-in.

BRAKE SYSTEMS

Remove tie rod lock nut and spherical nut. Then pull out cotter pins and clevis pins that hold operating lever to front brake shoe lever arm. Remove operating lever, tie rod, release spring and washers (fig. 44).

(5) REMOVE BRAKE SHOE ASSEMBLIES.

Wrench, socket, 1/2-in.

Remove brake shoe pin retainer cap screws, lock washers and pin retainers. Then pull out brake shoe pins and remove shoe assemblies.

d. Replacement of Brake Shoes.

Shims, 1/32-in., two, or feeler gages

Wrench, open-end, 5/16-in.

Wrench, open-end, 1/2-in.

Wrench, open-end, 3/8-in.

Wrench, open-end, 3/4-in.

Wrench, open-end, 7/16-in.

Wrench, open-end, 1 1/4-in.

Move hand lever to fully released position. Remove the tie rod lock nut, adjusting nut, and spring. Loosen the adjusting screws at the anchor bracket. Remove the brake shoe pivot pin retainers and the brake shoes will drop down. Remove the small spring connecting the lower ends of the brake shoes and the brake shoe pivot pins. To install, reverse the procedure given for removal of brake shoe.

e. Installation of Assembly.

Pliers

Wrench, open-end, 1 3/16-in.

Wrench, box, 5/8-in.

Wrench, open-end, 1 1/4-in.

Wrench, open-end, 3/8-in.

Wrench, socket, 1/2-in.

Wrench, open-end, 5/8-in.

(1) INSTALL BRAKE SHOE ASSEMBLIES.

Wrench, socket, 1/2-in.

Place brake shoe assemblies in position and install pins, pin retainers, lock washers and cap screws.

(2) INSTALL OPERATING LEVER TIE ROD.

Pliers

Wrench, open-end, 1 1/4-in.

Place tie rod, release spring, washers and operating lever in position. Install clevis pins and cotter pins to hold operating lever to lever arm. Install tie rod nut and lock nut.

(3) INSTALL DISK ASSEMBLY.

Wrench, box, 5/8-in.

Wrench, open-end, 5/8-in.

Raise propeller shaft and disk assembly into position and install the bolts, lock washers and nuts holding the rear propeller shaft flange to the transfer case companion flange.

SCOUT CAR M3A1

(4) INSTALL BRAKE ASSEMBLY.

Pliers

Wrench, open-end, $1\frac{3}{16}$ -in.

Wrench, open-end, $\frac{3}{8}$ -in.

Wrench, open-end, $1\frac{1}{4}$ -in.

Place assembly in position and install three cap screws and lock washers to hold anchor bracket to frame bracket. Install shoe spring. Adjust as described in paragraph 69 b.

(5) CONNECT PULL ROD AT OPERATING LEVER.

Pliers

Install rod and clevis pin and cotter pin to connect pull rod and operating lever.

Section XV

CLUTCH

	Paragraph
Description and operation.....	70
Trouble shooting	71
Maintenance and adjustment.....	72
Clutch removal	73
Clutch installation	74

70. DESCRIPTION AND OPERATION.

a. Description. The clutch is of the single-plate, dry-disk type which transmits power from the engine to the transmission.

b. Operation. Depressing the clutch pedal causes the clutch throw-out bearing to move toward the front and relieve spring pressure on a set of operating levers. The pressure on the driving plate is thereby removed and the clutch is in the "released" or "out" position. Letting the clutch "in" is the reverse procedure. The clutch should be either fully in or out while driving; and should be engaged, or let "in," gradually and not suddenly. A well adjusted clutch takes hold gradually, does not slip, and releases instantly when the pedal is depressed.

71. TROUBLE SHOOTING.

Improper operation of the clutch will be indicated in most instances by slipping, rattling, or chattering. Ordinarily the using arm will not attempt any repairs except to take up normal wear on the clutch facings and made a unit replacement. If any of the symptoms of defects arise, report to ordnance maintenance personnel.

a. Slipping.

Symptom and Probable Cause

Probable Remedy

Improper adjustment.

Adjust to give 1 to 1½-in. free travel (measured between the floor board and the pedal) before engagement begins.

Oily facings.

Clean and correct cause. Check bell housing oil seal. Do not overlubricate pilot or throw-out bearing. Replace assembly if surface cannot be restored to proper condition for operation without slippage.

Weak clutch spring.

Replace spring.

Worn clutch facings.

Replace clutch driven member assembly.

Sticking release sleeve.

Check pull-back spring.

SCOUT CAR M3A1

b. Rattling.

Symptom and Probable Cause

Loose release fork.
Weak pull-back springs.
Improper pedal adjustment.

Probable Remedy

Tighten fork.
Replace springs.
Adjust pedal.

c. Chattering.

Broken dampener springs.

Oily facings.

Sticking release sleeve.

Replace clutch driven member assembly.

Clean or replace clutch driven member assembly.

Check pull-back spring.

72. MAINTENANCE AND ADJUSTMENT.

The clutch should be adjusted when the wear on the clutch facings has decreased the free movement of the clutch pedal before disengagement starts to less than 1-inch (measured between the floor board and the pedal). The clutch should be adjusted so that the distance of free travel of clutch pedal is 1 to 1½ inches before disengagement begins. The adjustment is made through an adjusting yoke on the rod from the clutch

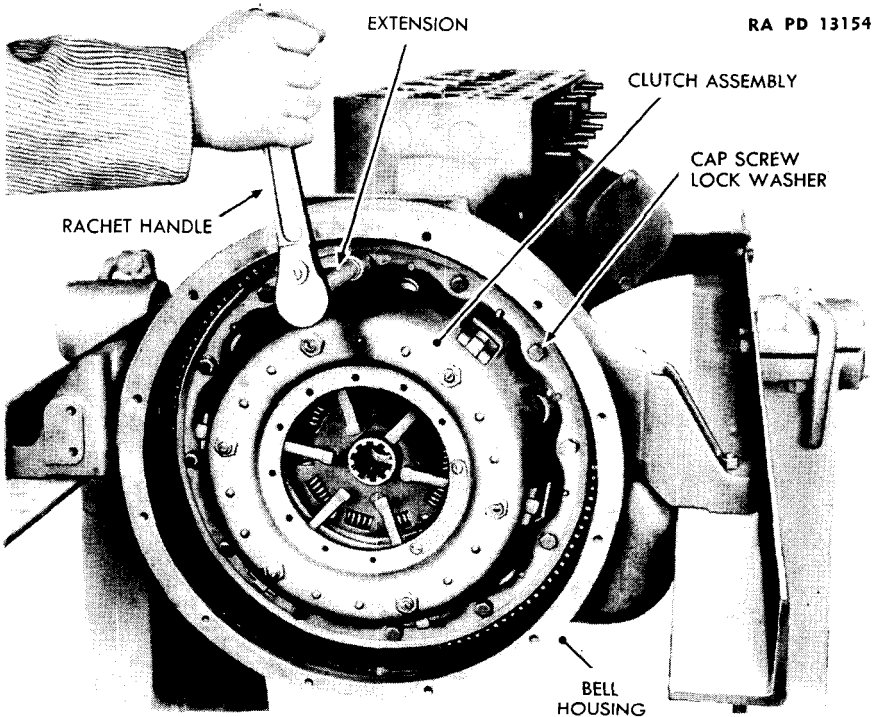

Figure 45 — Removing Clutch Assembly

CLUTCH

pedal to the lever on the clutch release shaft. If the correct adjustment cannot be obtained, a new driven member assembly is required. A few drops of oil every 500 miles is required to lubricate clutch release bearing. Oiler for this purpose is located in driver's compartment on floor board between shift handle and dash.

CAUTION: Adjustment of the 6 throwout fingers should not be attempted by the using personnel. This adjustment is made at the factory and can be adjusted correctly only by the use of special tools and procedure.

73. CLUTCH REMOVAL.

Handle, speed

Wrench, socket, $\frac{9}{16}$ -in.

a. **Remove Transmission.** Refer to paragraph 224, transmission removal.

b. Detach Clutch Assembly.

Handle, speed

Wrench, socket, $\frac{9}{16}$ -in.

Remove 12 cap screws with lock washers which hold clutch assembly to engine flywheel (fig. 45). Unscrew each cap screw a few turns at a time, so the release of the spring load is equal all around.

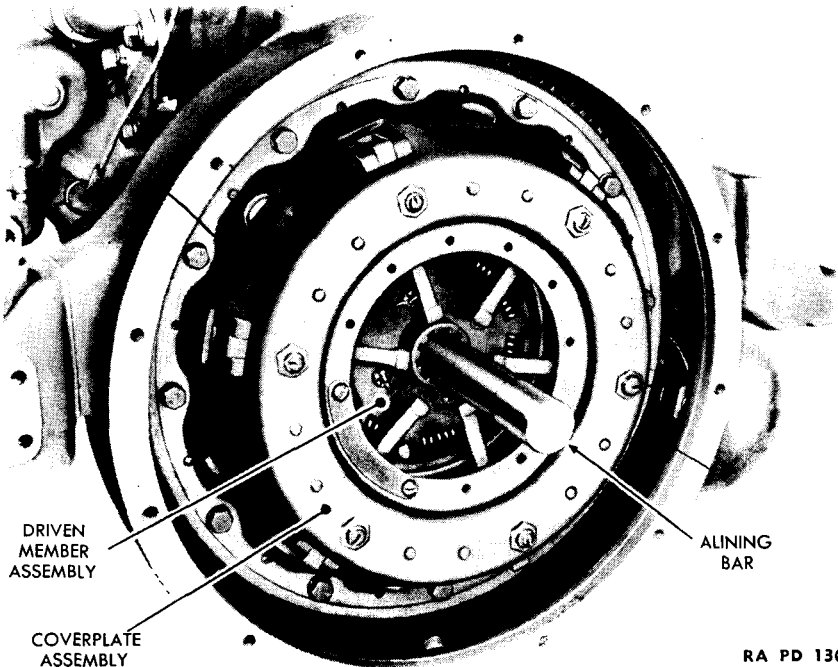

RA PD 13068

Figure 46 — Clutch Cover Plate Installation

SCOUT CAR M3A1

c. **Remove Cover Plate and Driven Member Assemblies.** Take off separately, cover plate assembly and driven member assembly. Take care that driven member does not fall out while removing cover plate assembly.

74. CLUTCH INSTALLATION.

Bar, pilot

Wrench, socket, $\frac{9}{16}$ -in.

Handle, speed

a. **Install Clutch.**

Bar, pilot

Wrench, socket, $\frac{9}{16}$ -in.

Handle, speed

A transmission main drive shaft may be used as a pilot bar to align the splined hub with the flywheel pilot bearing. Place aligning bar in clutch disk hub and insert it into clutch pilot bearing (fig. 46). Place clutch in position and secure to flywheel with 12 cap screws and lock washers (fig. 45). Tighten cap screws evenly to avoid bending cover plate.

b. **Install Transmission.** Refer to paragraph 225, Transmission Installation.

Section XVI
COOLING SYSTEM
(GASOLINE ENGINE POWERED VEHICLES)

	Paragraph
Description	75
Trouble shooting	76
Radiator	77
Fan	78
Water pump	79
Cautions	80
Servicing	81

75. DESCRIPTION (fig. 47).

The water cooling system consists of a radiator, fan and shroud, a centrifugal water pump, and the connecting lines and hoses. The capacity of the cooling system is 19 quarts. The system can be drained by opening the drain cocks at the bottom of the water pump and in the left rear side of the engine block.

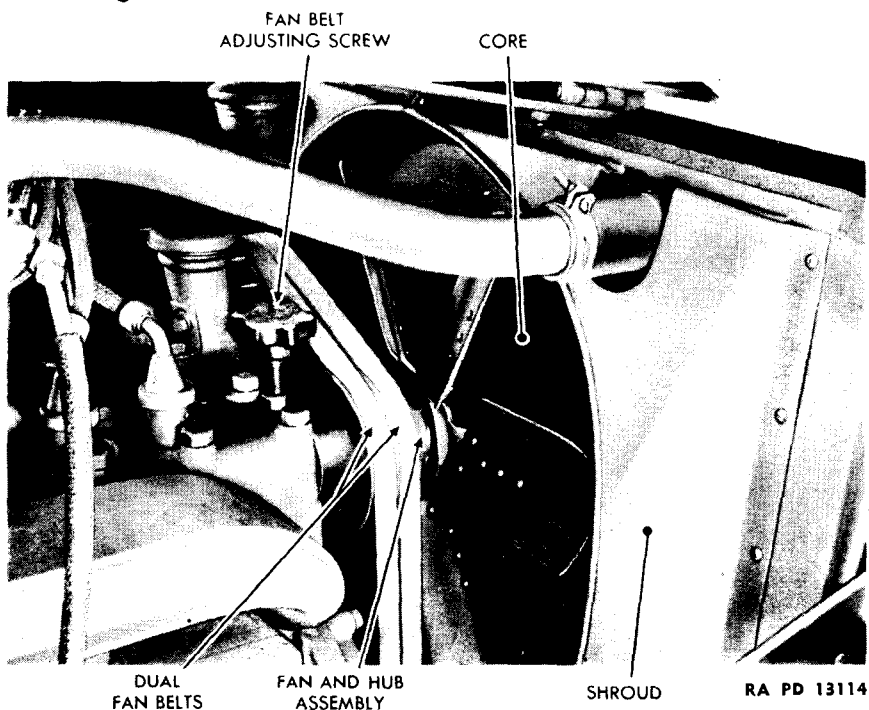

RA PD 13114

Figure 47 — Radiator with Shroud - Installed - (Gasoline Engine)

SCOUT CAR M3A1

76. TROUBLE SHOOTING.

Symptom and Probable Cause	Probable Remedy
-----------------------------------	------------------------

a. Overheating.

Lack of water.	Refill system.
Loose or damaged belts.	Adjust or replace belts.
Defective pump.	Replace pump.
Clogged system.	Flush and clean.
Clogged radiator core.	Clean.
Incorrect timing.	Check timing.
Defective hose.	Replace hose.

b. Leakage.

Defective hose.	Replace hose.
Loose connections.	Check and tighten.
Loose or open drain cocks and plugs.	Check and tighten.
Damaged radiator core.	Seal or replace radiator.

77. RADIATOR.

a. Description. The radiator is of reinforced sheet metal construction with brass tanks, and incorporates a finned tubular-type core.

b. Removal.

Hoist	Wrench, box, $\frac{9}{16}$ -in.
Pail	Wrench, open-end, $\frac{1}{2}$ -in.
Pliers	Wrench, open-end, $\frac{9}{16}$ -in.
Rope, length of	Wrench, socket, $\frac{3}{4}$ -in.
Screwdriver, heavy-duty square shank	Wrench, socket, $\frac{7}{8}$ -in., with universal attachment.

(1) DRAIN RADIATOR.

Pail	Pliers
------	--------

Open drain cock on lower left-hand hose connection and drain water into pail or on ground (save antifreeze solution if used).

(2) REMOVE HOOD.

Hoist	Screwdriver, heavy-duty square shank
Rope, length of	Wrench, open-end, $\frac{9}{16}$ -in.

Remove three elastic stop nuts and bolts at rear of center panel of hood. Remove nut and bolt on inside of louver frame, near the top, on each side of frame. Use rope and hoist to lift off hood with top of louver frame left on hood. Hood can also be slipped over front of car by three men.

COOLING SYSTEM (GASOLINE ENGINE POWERED VEHICLES)**(3) REMOVE LOUVER ASSEMBLY.**

Hoist	Wrench, box, $\frac{9}{16}$ -in.
Screwdriver, heavy-duty	Wrench, open-end, $\frac{1}{2}$ -in.

Remove bolts and nuts that hold louver frame to engine side armor plates. Disconnect louver control on lower right side of radiator. Lift louver frame straight up and out.

(4) REMOVE RADIATOR HOSE CONNECTIONS.

Screwdriver

Loosen clamps holding inlet and outlet radiator hoses and pull hoses loose from radiator.

(5) REMOVE RADIATOR.

Hoist	Wrench, socket, $\frac{7}{8}$ -in., with universal attachment
Wrench, socket, $\frac{3}{4}$ -in.	

Disconnect radiator from cross member by removing holding stud nuts, springs, washers and pads. Then disconnect stay rods at frame by removing nuts from stay rod bolts underneath car on the bottom side of the top frame flange (fig. 48). Remove radiator assembly by lifting up and slightly forward.

c. Installation.

Hoist	Wrench, open-end, $\frac{1}{2}$ -in.
Pliers	Wrench, open-end, $\frac{9}{16}$ -in.
Rope, length of	Wrench, socket, $\frac{3}{4}$ -in.
Screwdriver, heavy-duty square shank	Wrench, socket, $\frac{7}{8}$ -in., with universal attachment
Wrench, box, $\frac{9}{16}$ -in.	

(1) INSTALL RADIATOR (fig. 48).

Hoist	Wrench, socket, $\frac{7}{8}$ -in., with universal attachment
Wrench, socket, $\frac{3}{4}$ -in.	

Set radiator in position on pads so that mounting studs pass through holes in pads and frame member. Connect stay rods at frame with stay rod stud nuts. Place springs and washers on mounting studs and secure with nuts and cotter pins.

(2) INSTALL RADIATOR HOSE ASSEMBLIES.

Screwdriver

Install pipe and hose assemblies between cylinder head and radiator inlet connections and secure hose clamps. Then install pipe and hose assemblies between radiator outlet and water pump inlet connections and secure hose clamps.

SCOUT CAR M3A1

RADIATOR LOUVER ASSEMBLY

RADIATOR

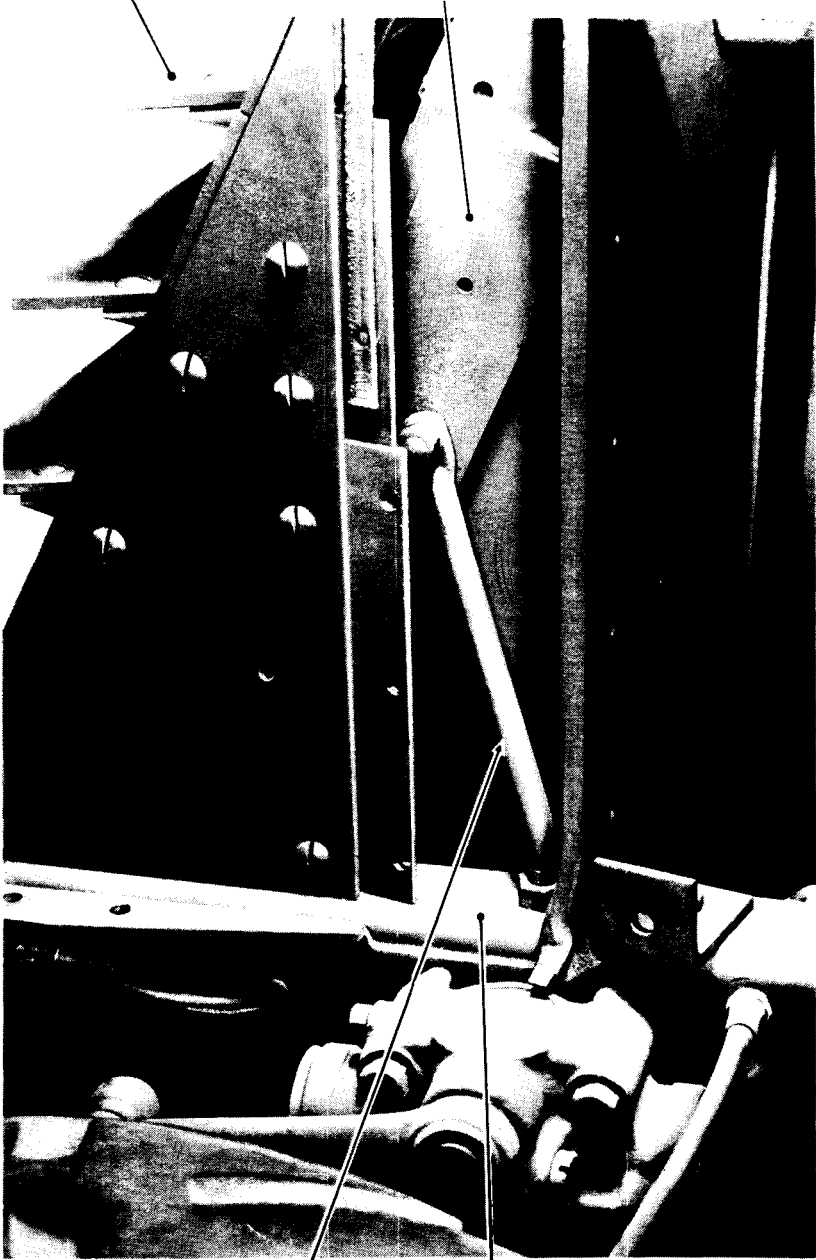

RADIATOR
STAY ROD

FRAME
FLANGE

RA PD 13010

Figure 48 — Radiator Support - Left Front View

COOLING SYSTEM (GASOLINE ENGINE POWERED VEHICLES)

(3) INSTALL LOUVER ASSEMBLY.

- | | |
|-------------------------|--------------------------------------|
| Hoist | Wrench, box, $\frac{9}{16}$ -in. |
| Screwdriver, heavy-duty | Wrench, open-end, $\frac{1}{2}$ -in. |

Place louver assembly in position with hoist. Secure louver side plates to body side plates with holding screws and nuts. Connect louver control at lower right side of radiator.

(4) INSTALL HOOD ASSEMBLY.

- | | |
|-----------------------|---------------------------------------|
| Hoist | Screwdriver, heavy-duty square shank |
| Rope, length of _____ | Wrench, open-end, $\frac{9}{16}$ -in. |

Place hood assembly and top shutter louver in position on cowl and shutter assembly. Install bolts and elastic stop nuts that secure rear of hood to cowl and front of hood to louver assembly. Remove rope from louver assembly.

(5) FILL RADIATOR. Fill radiator with water or antifreeze as required, and check for leaks.

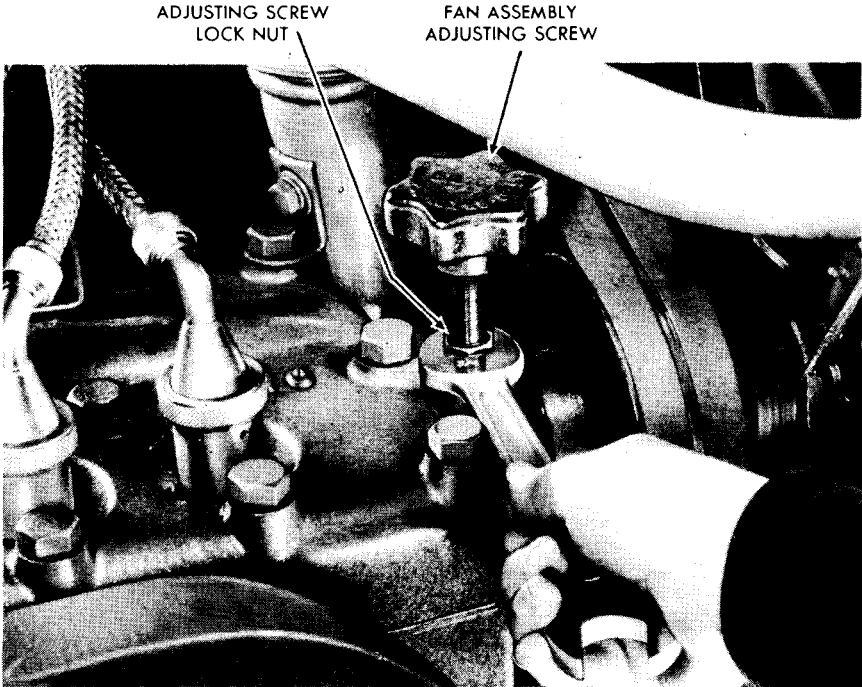

RA PD 13014

Figure 49 — Loosening Lock Nut on Adjusting Screw - (Gasoline Engine)

SCOUT CAR M3A1

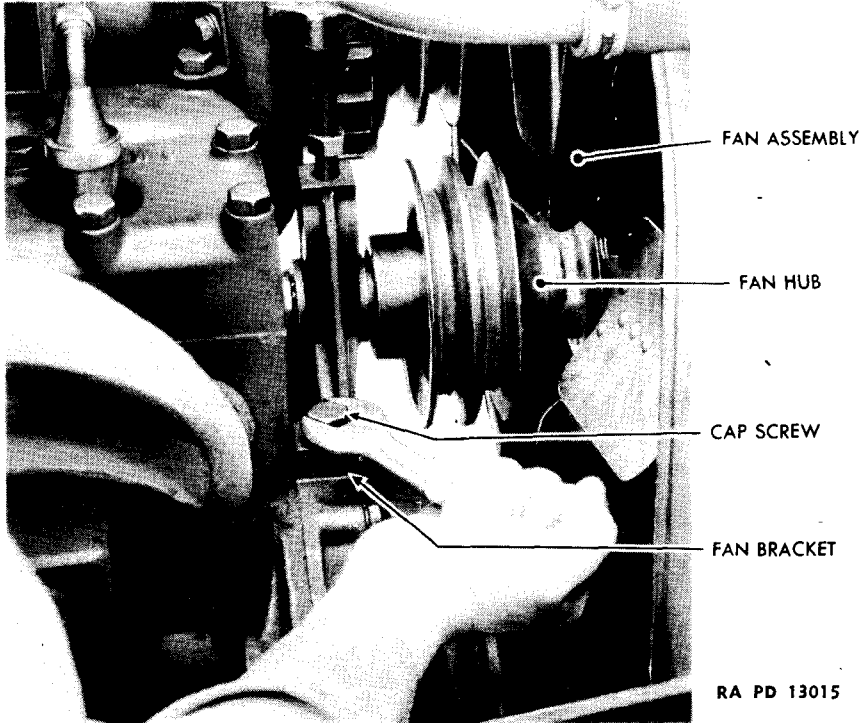

**Figure 50 — Fan Bracket Mounting, Screw Removal -
(Gasoline Engine)**

78. FAN (fig. 47).

a. Description. The air flow through the radiator core is maintained by movement of the vehicle and a six-bladed fan, which is enclosed in a shroud and driven off the crankshaft by dual V-belts.

b. Adjusting Fan Belts (fig. 49). Using a $\frac{3}{4}$ -inch open-end wrench, loosen the fan belt adjusting screw lock nut. Then turn the fan belt adjusting screw by hand to move the fan hub assembly up or down until there is between $\frac{1}{2}$ and $\frac{3}{4}$ of an inch deflection of the belts halfway between the pulleys, and tighten the lock nut.

c. Fan, Hub, and Bracket Assembly.

(1) REMOVAL.

Wrench, open-end, $\frac{3}{4}$ -in.

Wrench, open-end, $1\frac{1}{16}$ -in.

Loosen the fan belts as in paragraph 78 b. Using a $\frac{3}{4}$ -inch open-end wrench, remove the two cap screws and lock washers that attach the fan bracket to the timing gear case (fig. 50). Slide the belts off the fan drive pulley, generator pulley and fan pulley and remove the belts by lifting them up and over the fan blades. Push the fan assembly back against the cylinder block and tilt up the blade end to clear the radiator shroud. Then lift out the fan assembly and bracket (fig. 51).

COOLING SYSTEM (GASOLINE ENGINE POWERED VEHICLES)

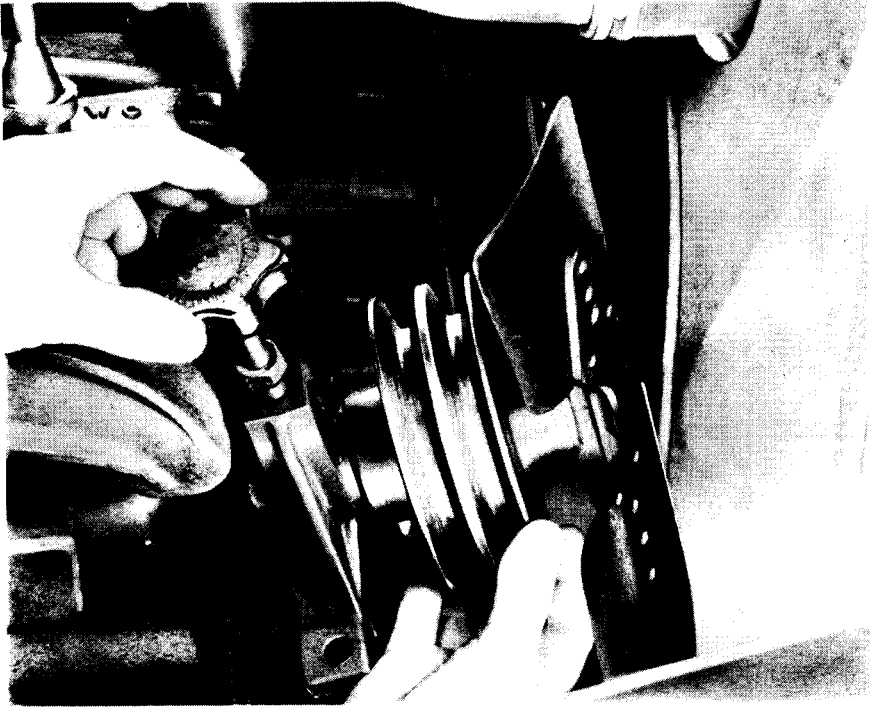

RA PD 13115

Figure 51 — Fan and Bracket Removal - (Gasoline Engine)

(2) INSTALLATION.

Wrench, open-end, $\frac{3}{4}$ -in.

Wrench, open-end, $1\frac{1}{16}$ -in.

With fan mounting bracket resting on the timing gear case, tilt the fan down and slip the belts over the fan blades and onto the drive pulley, fan pulley and generator pulley. Slide the mounting bracket into position on the timing gear case pad and insert the two attaching cap screws with lock washers. Adjust the bracket so that the fan pulley is lined up with the fan driving pulley, and tighten the cap screws. Screw down the fan adjusting screw until there is approximately $\frac{1}{2}$ to $\frac{3}{4}$ of an inch deflection of the fan belts, and tighten the lock nut. Check to make sure that the fan pulleys are properly aligned, and if misalignment is visible, loosen cap screw and shift bracket to correct position.

d. Fan Blades.

(1) REMOVAL.

Wrench, open-end or box, $\frac{1}{2}$ -in.

SCOUT CAR M3A1

FAN BLADE
ASSEMBLY

1/2-INCH
BOX WRENCH

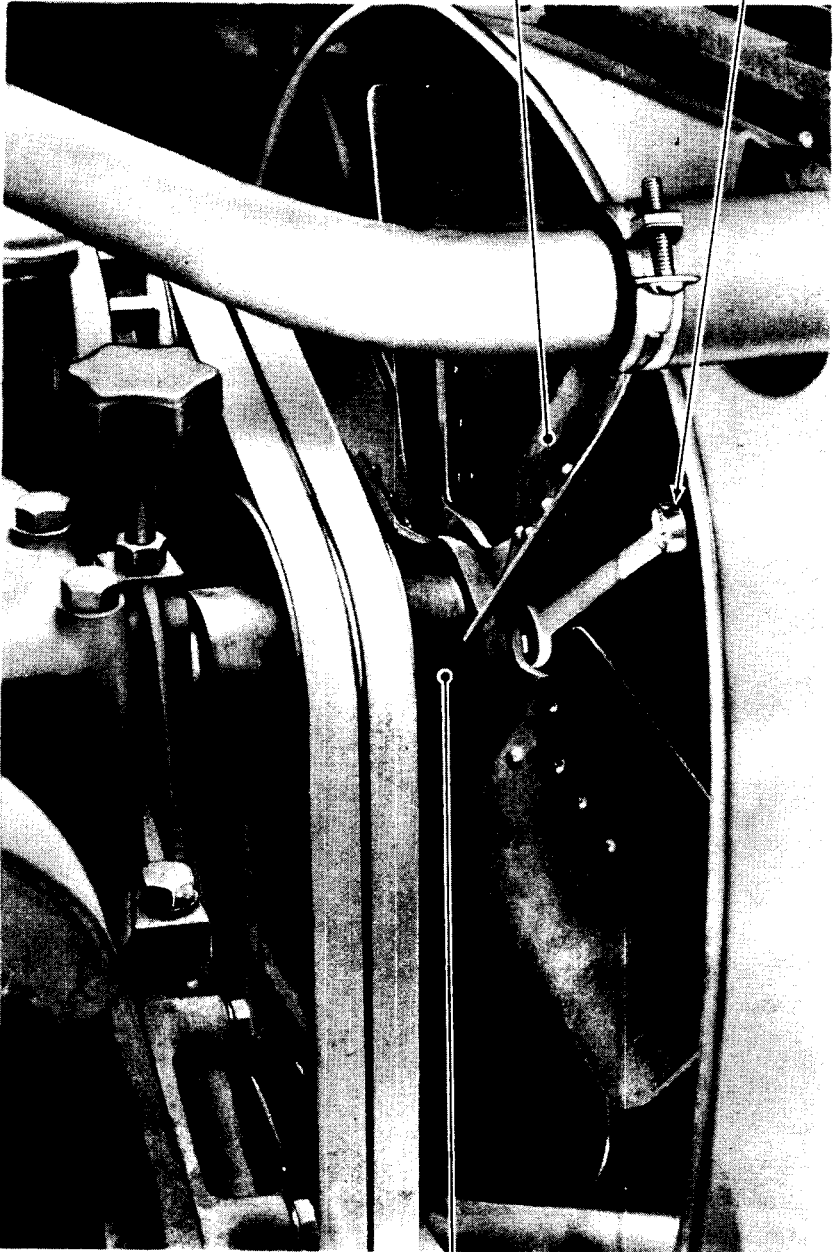

HUB

RA PD 13002

**Figure 52 — Wrench in Position for Removal of Fan
- (Gasoline Engine)**

COOLING SYSTEM (GASOLINE ENGINE POWERED VEHICLES)

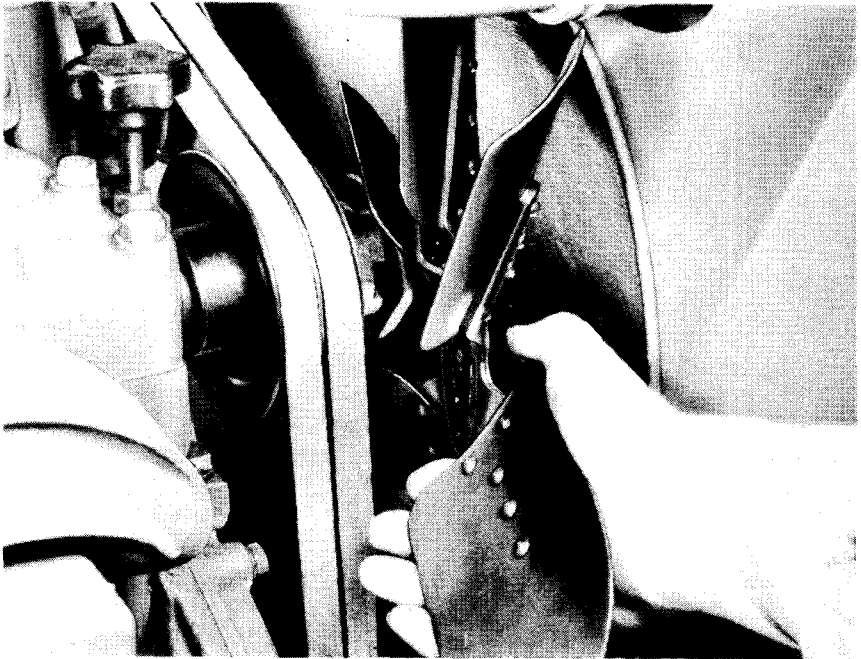

RA PD 13116

Figure 53 — Removing Fan Blade Only - (Gasoline Engine)

Remove the four cap screws and lock washers that hold the fan blades to the hub (fig. 52), then lift the fan blade out on the exhaust manifold side (fig. 53).

(2) INSTALLATION.

Wrench, open-end or box, $\frac{1}{2}$ -in.

Place the blade assembly in position and install the four lock washers and cap screws.

e. Lubrication. Every 1,000 miles the fan hub roller bearings should be lubricated by removing the slotted head screw in the hub, filling reservoir with OIL, engine seasonal grade (fig. 54).

79. WATER PUMP (fig. 55).

a. Description. The impeller-type water pump is supported by a sleeve flange from the front of the crankcase on the left side and is gear driven from the timing gear train. The pump may be removed without disturbing the gear cover.

b. Servicing. The packing nuts require very little pressure due to the ample width of packing used. When tightening the packing nuts to stop a water leak, use very little force, and if the leak does not stop, the pump should be repaired. Split ring type packing is furnished for service so that

SCOUT CAR M3A1

LUBRICATING FITTING

RA PD 13009

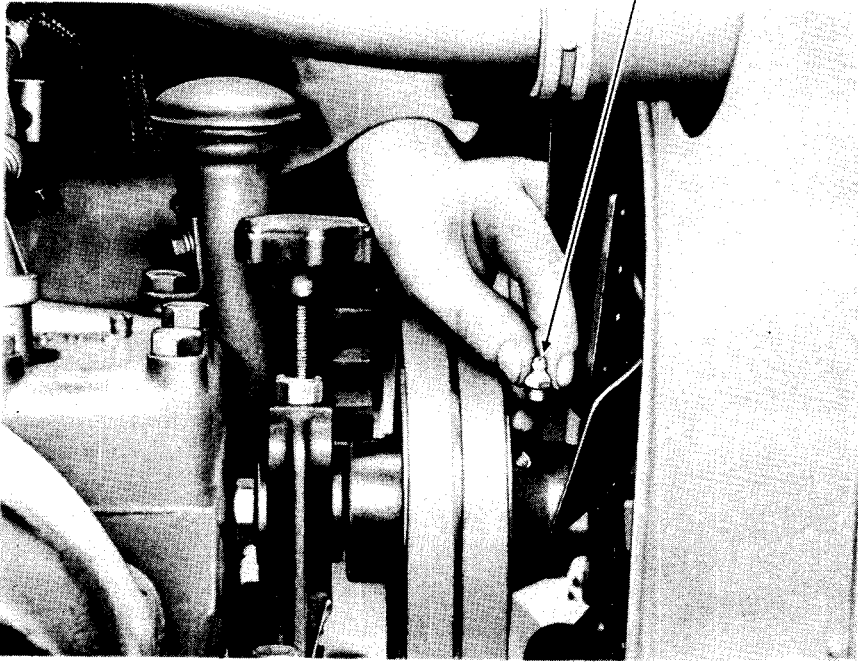

Figure 54 — Inserting Pressure Grease Fitting into Fan Hub - (Gasoline Engine)

the pump can be repacked without removal from engine. To repack water pump, unscrew packing gland nut, pry out gland and remove the old packing. Install new packing, slide gland back into position and screw on packing gland nut. Do not tighten packing gland nut. Fill radiator with water or antifreeze, start engine and check pump for leaks. Packing nut should be tightened while engine is running.

c. **Lubrication.** The front bushing for the pump shaft is automatically lubricated by the oiling system of the engine, while the rear bushing is lubricated by means of a grease cup on the water pump housing (fig. 55). Use GREASE, water pump, in this cup and give it one full turn every 500 miles.

d. Water Pump Removal.

Hammer, brass
Pliers
Screwdriver
Scriber

Straightedge
Wrench, open-end, $\frac{7}{16}$ -in.
Wrench, open-end, $\frac{9}{16}$ -in.
Wrench, open-end, $\frac{3}{4}$ -in.

(1) DRAIN COOLING SYSTEM.

Pliers

Open drain cock at lower left-hand radiator hose connection.

COOLING SYSTEM (GASOLINE ENGINE POWERED VEHICLES)

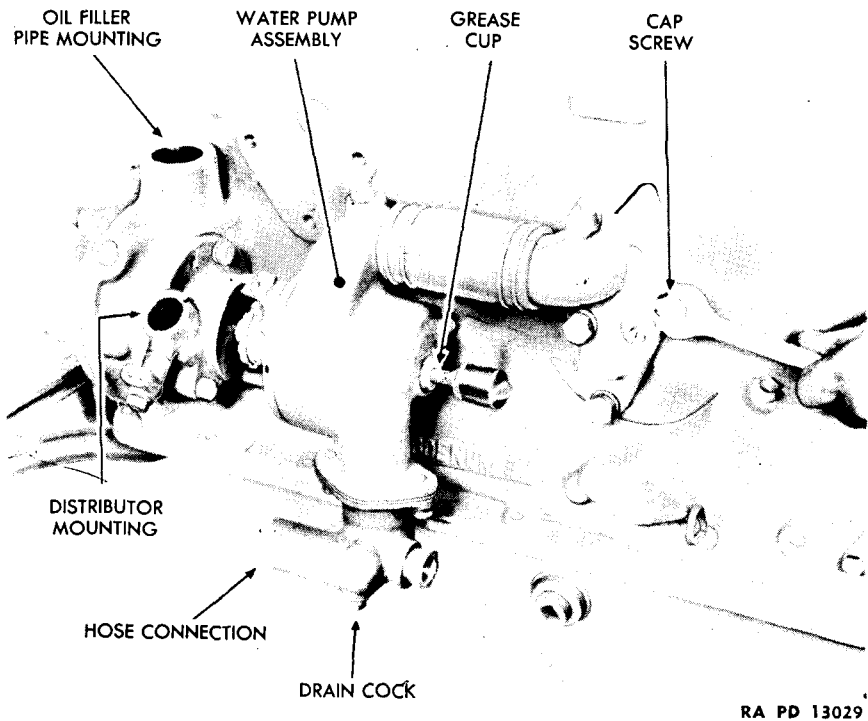

RA PD 13029

Figure 55 — Water Pump Assembly - (Gasoline Engine)

(2) REMOVE DISTRIBUTOR FROM WATER PUMP.

Screwdriver

Loosen spark control wire clamping screw and remove wire. Remove distributor advance screw with two plain washers and spring washer and carefully lift the distributor from its bearing so as not to move the distributor shaft.

(3) INDICATE DISTRIBUTOR SHAFT TIMING POSITION.

Scriber

Straightedge

Holding the distributor, place a straightedge on the shaft bearing in line over the drive gear retaining pin and scribe a line on the pin and bearing which will indicate the position of the gear when distributor is installed.

(4) DISCONNECT PUMP INLET AND CAR HEATER HOSE.

Screwdriver

Disconnect pump hose clamp and car heater hose clamp at water pump inlet elbow and slide hose from pipes.

(5) REMOVE PUMP ATTACHING SCREWS.

Wrench, open-end, $\frac{5}{16}$ -in.

Wrench, open-end, $\frac{3}{4}$ -in.

SCOUT CAR M3A1

Remove four cap screws and lock washers from water discharge inlet pipe. Then remove three cap screws and lock washers holding pump assembly to rear of gear housing.

(6) REMOVE PUMP ASSEMBLY.

Hammer, brass.

Pull back water pump until gear is clear of timing gear housing and lift out water pump assembly. Remove pump gasket and elbow gasket. It may be necessary to tap the pump lightly with a brass hammer to free the sleeve mounting from the gear case before the pump can be pulled out.

e. Water Pump Installation.

Screwdriver

Wrench, open-end, $\frac{3}{4}$ -in.

Wrench, open-end, $\frac{9}{16}$ -in.

(1) INSTALL WATER PUMP ASSEMBLY.

Wrench, open-end, $\frac{9}{16}$ -in.

Wrench, open-end, $\frac{3}{4}$ -in.

Place water pump assembly in position so that pump drive gear meshes with idler gear in gear case. Use new gasket between pump assembly and gear housing and between discharge pipe and block. Secure assembly between gear housing with lock washers and cap screws.

(2) CONNECT RADIATOR OUTLET HOSE AND CAR HEATER HOSE TO PUMP INLET ELBOW.

Screwdriver

Slide radiator heater hose on connections; then tighten hose clamps.

(3) INSTALL DISTRIBUTOR ON PUMP COVER. Making sure that scribed lines on distributor bearing and on drive gear retaining pin are in line, slide distributor in mounting bearing on pump cover so that slot in distributor advance arm is over arm retaining screw lug.

(4) CONNECT SPARK CONTROL WIRE AND SECURE DISTRIBUTOR.

Screwdriver

Insert spark control wire in swivel hole on advance arm and tighten clamping screw. Then replace distributor arm advance control retaining screw with one shakeproof and two plain washers. **NOTE:** If the engine is rotated for the disassembly of other parts, or for any other reason during the time that the water pump and distributor are removed from the engine, the ignition will have to be retimed. See section XIX for timing procedure.

(5) INSPECTION. After the water pump has been installed and water replaced in the cooling system, run the engine at idling speed. Inspect the

COOLING SYSTEM (GASOLINE ENGINE POWERED VEHICLES)

hose connections, flanges and packing gland nut for water leaks. Inspect the shaft, where it comes through the pump cover and the oil line connections at the engine block elbow flange for oil leaks.

80. CAUTIONS.

The following precautions should be carefully noted:

- a. There must always be a sufficient supply of water in the system.
- b. If the engine should run low on water, and overheat, it should be stopped and allowed to cool before refilling the system.
- c. Hose connections should be examined frequently and replaced if they show signs of disintegration, to prevent leaks and obstructions in the cooling system caused by loose particles.
- d. Whenever it is necessary to operate the engine while the vehicle is not moving, for the purpose of maintaining radio communication, the heat indicator will be watched attentively. If the temperature of the engine rises excessively (200 F or midway on the indicator gage between 180 F and 220 F), the engine will be stopped.
- e. Every vehicle in which a tendency to overheat (temperature increase above 180 F) is discovered will be given a complete check as soon as possible, and the necessary corrections will be made to eliminate the overheating tendency. Under no circumstances will an engine be permitted to continue to run when the heat indicator shows an excessive engine temperature.
- f. Circumstances permitting, engine overheating may be relieved somewhat by facing vehicle into the wind, and/or opening the hood. Shutters normally must be open in any event. Prolonged engine operation, with vehicle at standstill, for the purpose only of charging a battery will be discouraged. Discharged batteries must be replaced and recharged from another source.
- g. Drain the system in cold weather if there is no antifreeze. It is advisable to run the engine for ½ minute after draining to insure elimination of water pockets in the crankcase and pump.
- h. In freezing weather, the cooling system should be filled with an antifreeze solution. **ETHYLENE GLYCOL** (Prestone) is preferred for the antifreeze solution. If **ETHYLENE GLYCOL** is not available, the other materials shown in the table may be used. The table shows the quantity of antifreeze needed to make a gallon of solution which will not freeze at the indicated temperatures.

SCOUT CAR M3A1

(1) ANTIFREEZE CHART.

Freezing Point	Pints Ethylene Glycol (Prestone) Per Gallon of System capacity	Pints Glycerine Grade A, U.S.P. Per Gallon of System capacity	Pints Denatured Alcohol Per Gallon of System capacity
10 F	2	3	2½
0 F	2½	3½	3
-10 F	3	3½	3½
-20 F	3½	4	4
-30 F	4	5	5
-40 F	4½	—	5½
-50 F	4½	—	6
-60 F	5	—	6½
-70 F	5	—	—

(2) To prevent excessive cooling of the engine and poor combustion in cold weather, the radiator louvers should be partly closed or the radiator core partly covered in some manner.

81. SERVICING.

Cooling systems should be given a systematic servicing every 6,000 miles, or about twice a year (spring and fall). Cooling systems should always be serviced before the introduction of an antifreeze solution into the system and after its removal. Add ½-pint rust solvent each time system is serviced.

a. Cleaning. The servicing of the cooling system consists of dissolving the dirt, rust, scale, and grease in the system, and flushing. The operation is initiated by removing one gallon of water and adding a solution of one pound of washing soda (sal soda) or ½ pound of SODA ASH in one gallon of clean water. The engine should then be run until the solution boils thoroughly, after which it can be drained from the system by disconnecting the lower hose connection.

b. Flushing. Flushing of the system should be effected in the direction opposite to the direction of normal flow. The radiator should be flushed up from the lower hose connection and out the upper hose connection.

c. Refilling. Before reconnecting clamps and sections of hose, examine carefully for serviceability, and replace unserviceable parts. System should be made waterproof and refilled.

d. Thawing. If the water in the cooling system of a vehicle freezes solid, it must be thawed by placing the vehicle in a warm place. Under

COOLING SYSTEM (GASOLINE ENGINE POWERED VEHICLES)

no circumstances should the engine be run when the water in the system is completely frozen. In the case of mush ice, it is safer to place the vehicle in a warm place, but the ice may be thawed by covering the radiator and running the engine slowly. First remove the radiator filler cap and start the motor. Run the engine slowly, meanwhile keeping the level of the radiator fluid constant by addition of coolant as needed. Run the engine until proper circulation is established.

CAUTION: Care should be taken to avoid possibility of personnel injury due to sudden escapement of steam.

e. Linkages. Check radiator supports and tie rods and tighten when necessary. Check connections of control linkage to louvers.

SCOUT CAR M3A1

Section XVII

COOLING SYSTEM (HERCULES DIESEL ENGINE)

	Paragraph
Description	82
Trouble shooting	83
Radiator	84
Fan	85
Water pump	86
Thermostat	87
Cautions	88
Servicing	89

82. DESCRIPTION.

The water cooling system consists of a radiator, fan and shroud, a centrifugal water pump, thermostat, and the connecting lines and hoses.

83. TROUBLE SHOOTING.

Refer to paragraph 76.

84. RADIATOR.

Refer to paragraph 77.

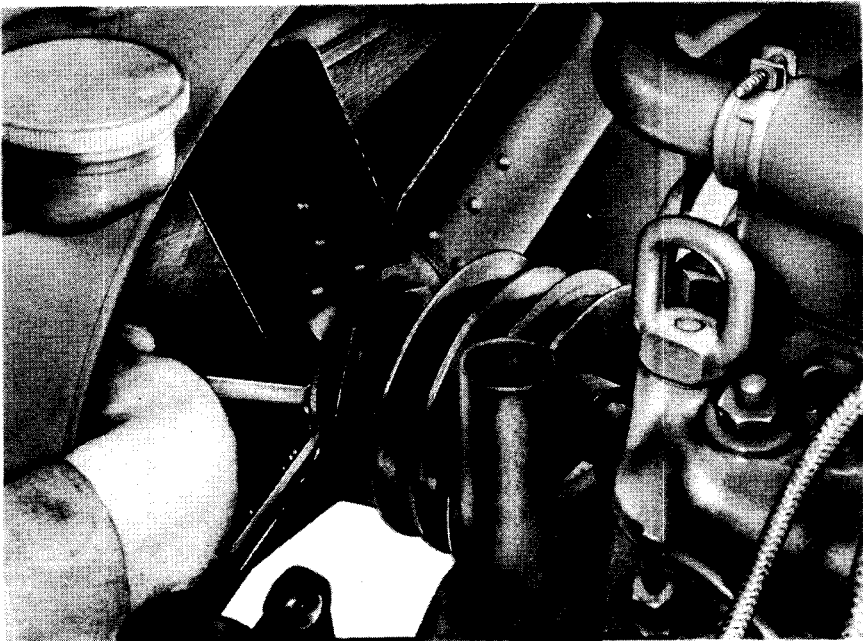

RA PD 13119

Figure 56 — Removing Fan Blade Holding Bolts - (Hercules Diesel)

COOLING SYSTEM (HERCULES DIESEL ENGINE)

85. FAN.

The air flow through the radiator core is maintained by movement of the vehicle and a four-bladed fan, which is enclosed in a shroud and driven off the crankshaft by dual belts. These belts also drive the generator. A third belt from the fan pulley is used to drive the vacuum pump.

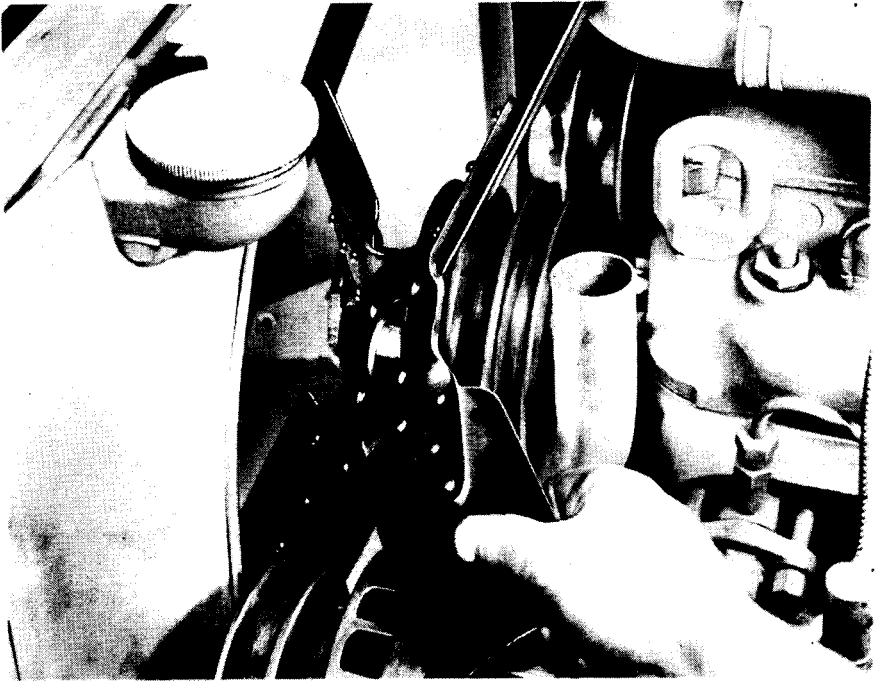

RA PD 13118

Figure 57 — Removing Fan Blade from Engine Compartment - (Hercules Diesel)

a. Fan Blade.

(1) REMOVAL.

Wrench, box, 1/2-in.

Remove the four cap screws that hold the fan blades to the hub (fig. 56) and lift the fan out of the engine compartment (fig. 57).

(2) INSTALLATION.

Wrench, box, 1/2-in.

Place the fan in position on the hub and install the four cap screws that hold the fan blades in place.

SCOUT CAR M3A1**b. Fan Pulley and Bracket.****(1) REMOVAL.**

Wrench, open-end, $\frac{3}{4}$ -in., offset Wrench, socket, $\frac{3}{4}$ -in., with ratchet

Remove the fan belts (par. 85 e). Using a $\frac{3}{4}$ -inch socket wrench with ratchet, remove the generator belt adjusting bracket. Remove the fan blades from the hub (par. 85 a). Remove the vacuum pump belt from the fan hub. Using a $\frac{3}{4}$ -inch open-end offset wrench, remove the four nuts that hold the fan and pulley bracket to the engine block (fig. 58). Remove the oil filler cap, and lift the fan pulley and hub assembly out over the oil filler pipe (fig. 59).

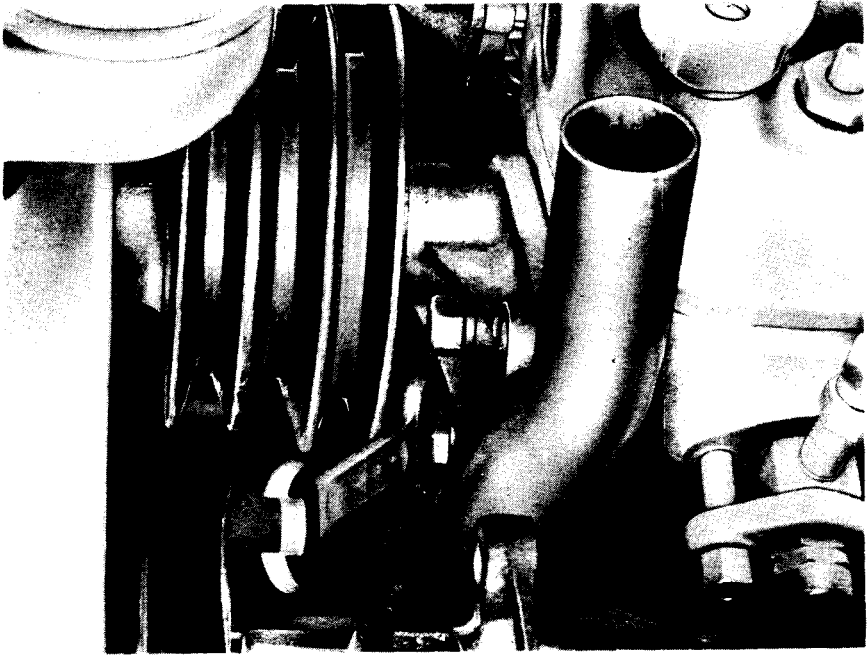

RA PD 13120

Figure 58 — Removing Pulley and Bracket Assembly Holding Cap Screw - (Hercules Diesel)

(2) INSTALLATION.

Wrench, open-end, $\frac{3}{4}$ -in., offset Wrench, socket, $\frac{3}{4}$ -in., with ratchet

Place the fan pulley and hub assembly in position and install the four nuts that hold the bracket to the engine block. Then install the oil filler cap on the oil filler pipe. Install the vacuum pump belt on the fan hub and adjust. Install the fan blades on the hub (par. 85 a). Install the generator belt adjusting bracket ($\frac{3}{4}$ -in. socket wrench with ratchet). Install the fan belts and adjust.

COOLING SYSTEM (HERCULES DIESEL ENGINE)

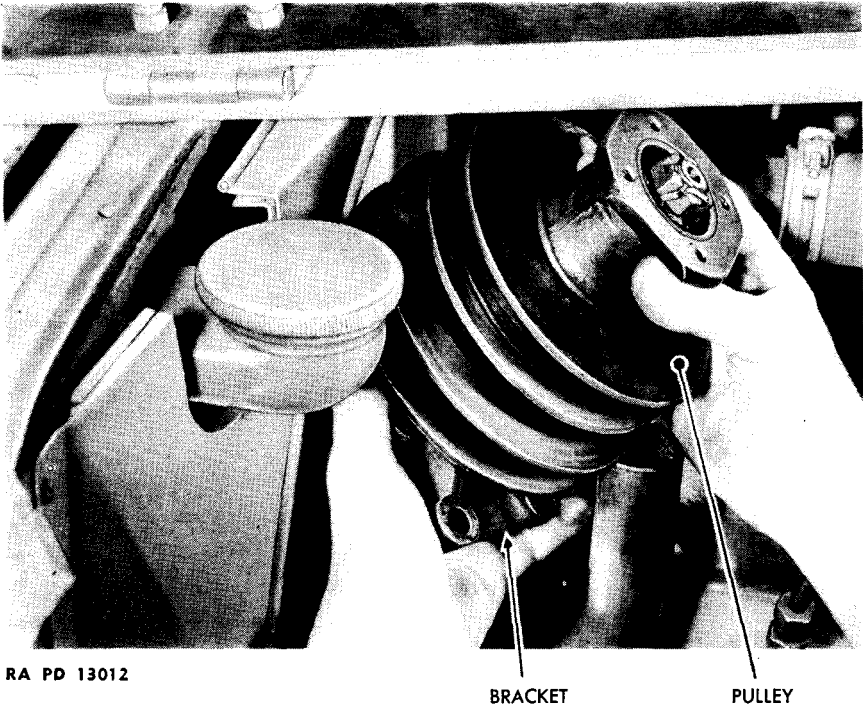

RA PD 13012

BRACKET

PULLEY

Figure 59 — Removing Pulley and Bracket Assembly from Vehicle - (Hercules Diesel)

c. Adjusting Fan Belts. The belt which drives the fan and generator is adjusted by the generator adjusting bracket. Using a $\frac{3}{4}$ -inch socket wrench with ratchet, loosen the bolt on the bracket, and with $\frac{7}{8}$ -inch open-end wrench loosen the two bolts which hold generator to mounting bracket. Move the generator until the desired tension on the belt is achieved and tighten the bolts. For proper adjustment there should be $\frac{1}{2}$ - to $\frac{3}{4}$ -inch deflection of fan belts midway between the two pulleys.

d. Lubricating. Every 1,000 miles of operation the fan bearing should be lubricated. With a screwdriver, remove the plug in the fan hub (fig. 60). Fill reservoir with OIL, engine, seasonal grade.

e. Replacing Fan Belts.

Screwdriver, heavy

Wrench, socket, $\frac{3}{4}$ -in., with ratchet

Wrench, open-end, $\frac{7}{8}$ -in.

Loosen, but do not remove, the two bolts which hold the generator to the generator bracket. These bolts are located under the generator. The bolts can be loosened with a $\frac{7}{8}$ -inch open-end wrench, and a $\frac{3}{4}$ -inch socket wrench. Using a $\frac{3}{4}$ -inch socket wrench with ratchet, loosen the

SCOUT CAR M3A1

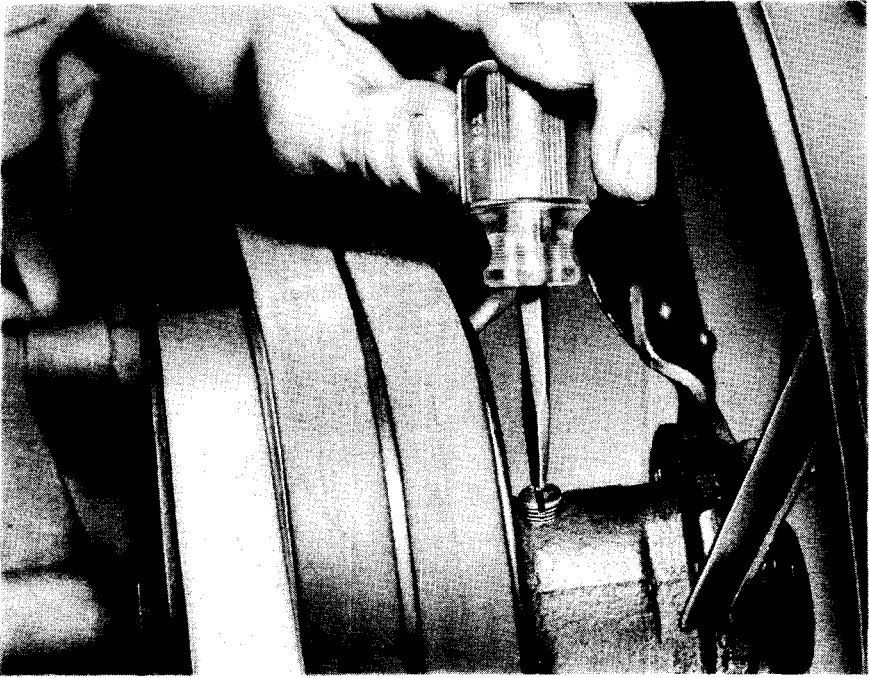

RA PD 13117

**Figure 60 — Removing Lubricating Plugs on Fan Assembly -
(Hercules Diesel)**

bolt which extends through the slotted end of the belt adjustment bracket. Push the generator in toward the engine as far as it will go to loosen the tension on the drive belts. Pry off the two generator drive belts with a heavy screwdriver. Place the screwdriver under the belts at the pulley on the generator. With a screwdriver, remove shroud crank tunnel located under radiator, and remove belts. Install new belts, and pull the generator out from the engine to produce the desired tension on the belts. Then tighten the bolts on the adjusting bracket and underneath the generator. Replace shroud crank tunnel.

86. WATER PUMP.

a. Description. The centrifugal type water pump is supported at the front of the crankcase on the right side, and is gear driven from the timing gear train.

b. Removal.

Screwdriver

Wrench, socket, 1/2-in.

Wrench, open-end, 9/16-in.

Drain the cooling system. Disconnect bypass and radiator hose connec-

COOLING SYSTEM (HERCULES DIESEL ENGINE)

VACUUM PUMP MOUNTING PAD

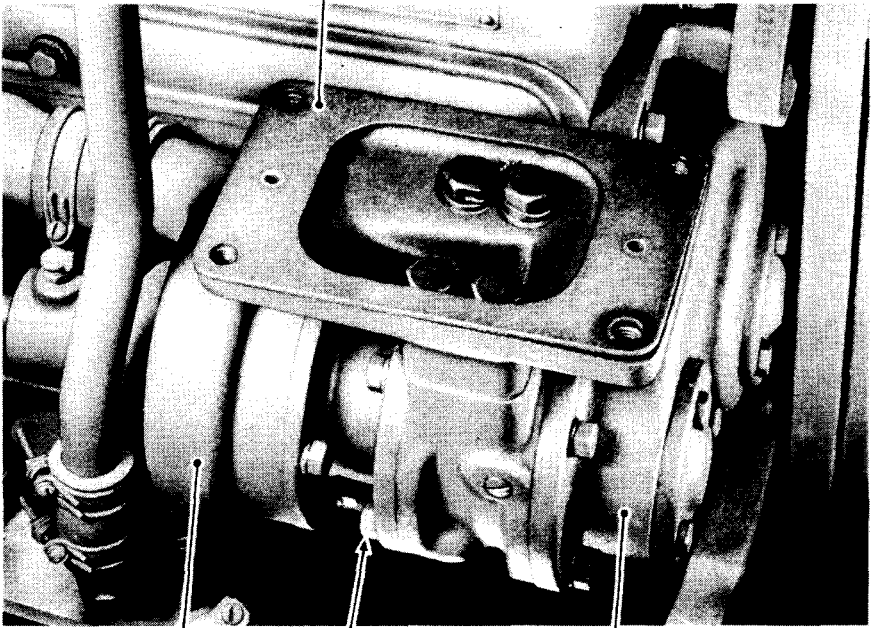

WATER PUMP

CAP SCREW

TIMING GEAR CASE

RA PD 13121

Figure 61 — Water Pump, Installed - (Hercules Diesel)

tion from water pump connection by removing two cap screws and lock washers. Remove two cap screws and lock washers securing water connection to cylinder block. Remove four cap screws from water pump mounting flange at the front of the pump assembly. Pull pump back until gear is clear and lift out pump assembly with cylinder block connection, (fig. 62).

c. **Servicing.** There are two packless seals in the hub of the impeller. If seals begin to leak, replacement of them will not correct the trouble. Defective bearings are indicated. Report to ordnance personnel.

d. Installation.

Screwdriver

Wrench, socket, 1/2-in.

Wrench, open-end, 9/16-in.

Using a new gasket at each connection, place the pump in position on the engine. Install the four cap screws and lock washers in the mounting flange at the front of the pump assembly, and the two cap screws and lock washers at the water connections at the side of the cylinder block. Secure bypass and radiator hose connection with two cap screws and lock washers, and tighten all hose clamps. Fill radiator with water or antifreeze.

SCOUT CAR M3A1

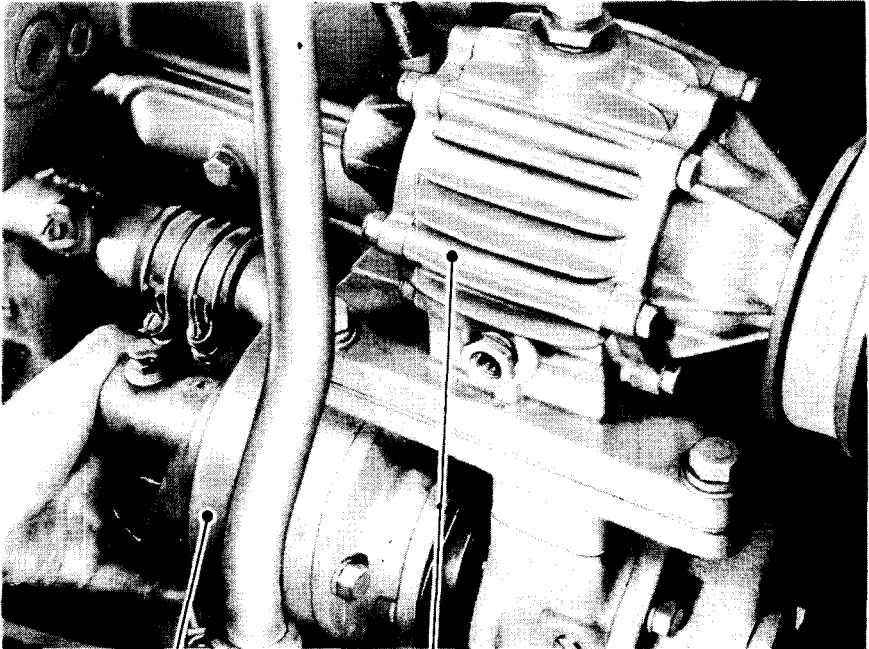

WATER
PUMP

VACUUM
PUMP

RA PD 13027

Figure 62 — Removal of Water Pump - (Hercules Diesel)

e. **Lubrication.** The bushing in the pump at the timing gear end is lubricated through an oil passage which lines up with the gear compartment of the engine. The bearing at the water inlet end of the pump must be lubricated every 500 miles through the oiler provided on the pump housing. Always use oil and never grease.

87. THERMOSTAT.

a. **Description.** A bellows-type thermostat is located in the forward end of the water outlet manifold. A bypass pipe extends from the thermostat down to the water pump (fig. 62).

b. Removal.

Screwdriver

Wrench, socket, $\frac{9}{16}$ -in., with ratchet

Partially drain the cooling system to lower the fluid level in the radiator below the level in the water outlet manifold. Use a screwdriver to loosen the hose clamps, and slide back the hoses. Using a $\frac{9}{16}$ -inch socket wrench and ratchet, remove the four cap screws and lock washers, from the thermostat housing. Raise the thermostat housing and lift out the thermostat (fig. 63).

COOLING SYSTEM (HERCULES DIESEL ENGINE)

c. Installation.

Screwdriver

Wrench, socket, $\frac{9}{16}$ -in., with ratchet

Place the thermostat unit in its housing. Using a new gasket, secure the housing into position with the four cap screws and lock washers. Slide the hose forward over the connection and tighten the clamp.

88. CAUTIONS.

Refer to paragraph 80.

89. SERVICING.

Refer to paragraph 81.

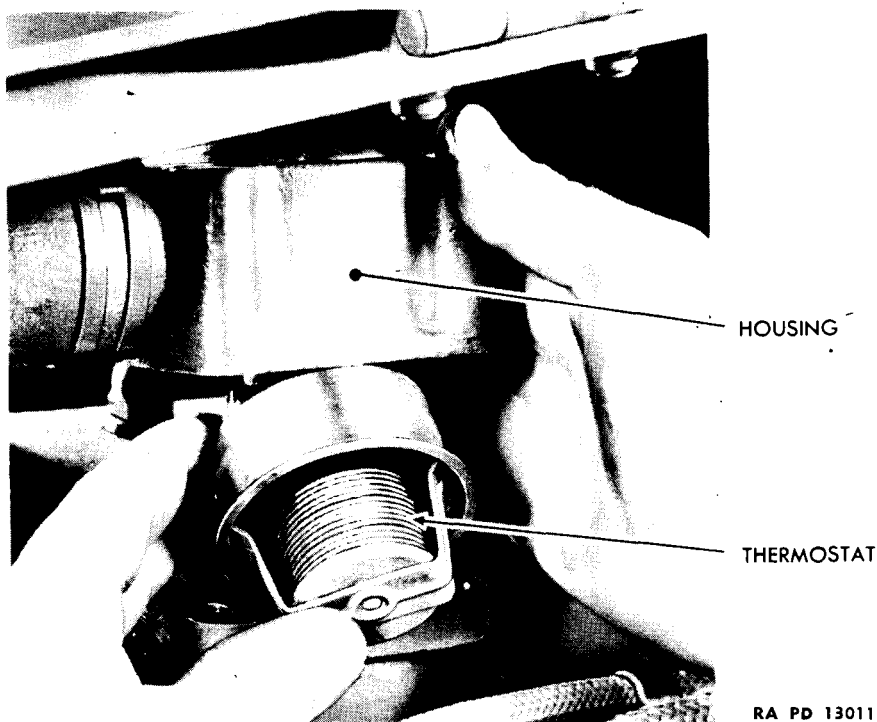

Figure 63 — Removal of Thermostat - (Hercules Diesel)

SCOUT CAR M3A1

Section XVIII

COOLING SYSTEM (BUDA DIESEL ENGINE)

	Paragraph
Description	90
Trouble shooting	91
Radiator	92
Fan	93
Water pump	94
Thermostat	95
Cautions	96
Servicing	97

90. DESCRIPTION.

The water cooling system consists of a radiator, fan and shroud, an impeller type water pump, thermostat, and the connecting lines and hoses. The water drawn to the pump passes through the water manifold to the cylinder casting at points between each pair of cylinders. At the points of entry, a brass water distributor tube is inserted in the cylinder casting which directs the stream around the cylinder barrels. The water then passes upward to the head and across the head to the water outlet manifold.

91. TROUBLE SHOOTING.

See paragraph 76.

92. RADIATOR.

See paragraph 77.

93. FAN.

a. **Description.** The air flow through the radiator core is maintained by movement of the vehicle and a six-bladed fan, which is enclosed in a shroud and driven off the crankshaft by dual belts. These belts also drive the generator.

b. **Removing Fan and Pulley.** The pulley and fan are mounted on the water pump shaft. The water pump, fan, and pulley are removed as a unit, and then disassembled. Refer to paragraph 94.

c. **Adjusting Fan Belts.** The belts which drive the fan and generator are adjusted by loosening the bolt on the generator adjusting strap, and moving the generator until the belt can be deflected between $\frac{1}{2}$

COOLING SYSTEM (BUDA DIESEL ENGINE)

to $\frac{3}{4}$ inch midway between the generator and crankshaft pulley. Then tighten the bolt.

d. Removal and Installation.

Wrench, open-end, $\frac{9}{16}$ -in.

Loosen, but do not remove, the bolts which hold the generator to the mounting bracket. Loosen the locking bolt which extends through the slotted end of the generator adjusting strap. Push the generator in toward the engine as far as it will go to loosen the tension on the belts. Pry off the unserviceable belts and install new belts. Pull the generator out to produce the desired tension on the new belts, and tighten the locking bolts.

94. WATER PUMP.

a. **Description.** The water pump is mounted at the front of the engine. The fan and pulley are mounted on the water pump shaft.

b. Removal.

Pliers

Wrench, open-end, $\frac{9}{16}$ -in.

Screwdriver

Drain the cooling system. Remove the fan belts (par. 93 d). Free the hose clamps and remove the hose from the water pump. Using a $\frac{9}{16}$ -inch open-end wrench, remove the four mounting cap screws and lift off the fan, pulley, and water pump assembly. Remove the gasket.

c. Installation.

Pliers

Wrench, open-end, $\frac{9}{16}$ -in.

Screwdriver

Install the pump assembly in position with a new gasket, and secure with the four mounting cap screws. Connect the hose to the water pump and tighten the clamps. Install the fan belts on the pulley (par. 93 d). Fill the cooling system.

95. THERMOSTAT.

a. **Description.** A thermostat is located in a thermostat housing at the water outlet. A bypass pipe extends from the thermostat housing at the water outlet. On a cold engine, the water from the outlet flows downward through the bypass pipe to the inlet connection on the water pump without passing through the radiator. As the engine warms up, the thermostat gradually closes, permitting an increasing amount of water to pass through the radiator.

b. Removal.

Pliers

Wrench, open-end, $\frac{9}{16}$ -in.

Screwdriver

Partially drain the cooling system to lower the water level in the

SCOUT CAR M3A1

radiator below the level in the water outlet. Use a screwdriver to loosen the hose clamps and remove the hose at the thermostat housing. Use a $\frac{9}{16}$ -inch open-end wrench to remove the four thermostat housing mounting cap screws, and pull the thermostat housing back from the water outlet manifold. Remove the thermostat element from the housing.

c. Installation.

Pliers

Wrench, open-end, $\frac{9}{16}$ -in.

Screwdriver

Install a thermostat element in the housing and attach the housing at the water outlet manifold, using a new gasket. Install the hose and tighten the clamps. Fill the cooling system.

96. CAUTIONS.

Refer to paragraph 80.

97. SERVICING.

Refer to paragraph 81.

Section XIX

**ELECTRICAL SYSTEM AND ACCESSORIES
(GASOLINE ENGINE POWERED VEHICLES)**

	Paragraph
General description	98
Battery	99
Starting motor	100
Generator	101
Voltage regulator and filter.....	102
Ignition coil	103
Distributor	104
Spark plugs	105
Shielding	106
Timing	107
Ignition trouble shooting.....	108
Fuses	109
Switches	110
Terminal box	111
Head lamps	112
Tail lamps	113
Heater	114
Horn	115

98. GENERAL DESCRIPTION.

The 12-volt electrical system is of the single-wire, ground-return type and is energized from a storage battery with negative terminal grounded to the frame. The system is divided into three general classifications to include the battery, starter, generator, and voltage regulator; the closed circuit battery and coil, high tension ignition group; and the miscellaneous lighting, protective, and control equipment. The electrical wiring diagrams are shown in figures 64 and 65. Figure 65 shows the diagram for the latest design which includes: Radio shielding on the electrical system. The systems, however, are fundamentally the same.

99. BATTERY.

The 6-cell, 25-plate lead-acid type battery is rated at 168 ampere hours, and is located in a compartment at the side of the frame below the right door. Radio connection terminals are attached to ears on the battery terminals by means of wing nuts.

a. Voltmeter Check. A direct-current voltmeter is provided and can be used to indicate to some degree the battery's condition as far as its capacity to supply current is concerned. With the engine shut down and no load on the battery, the open circuit reading should be approxi-

SCOUT CAR M3A1

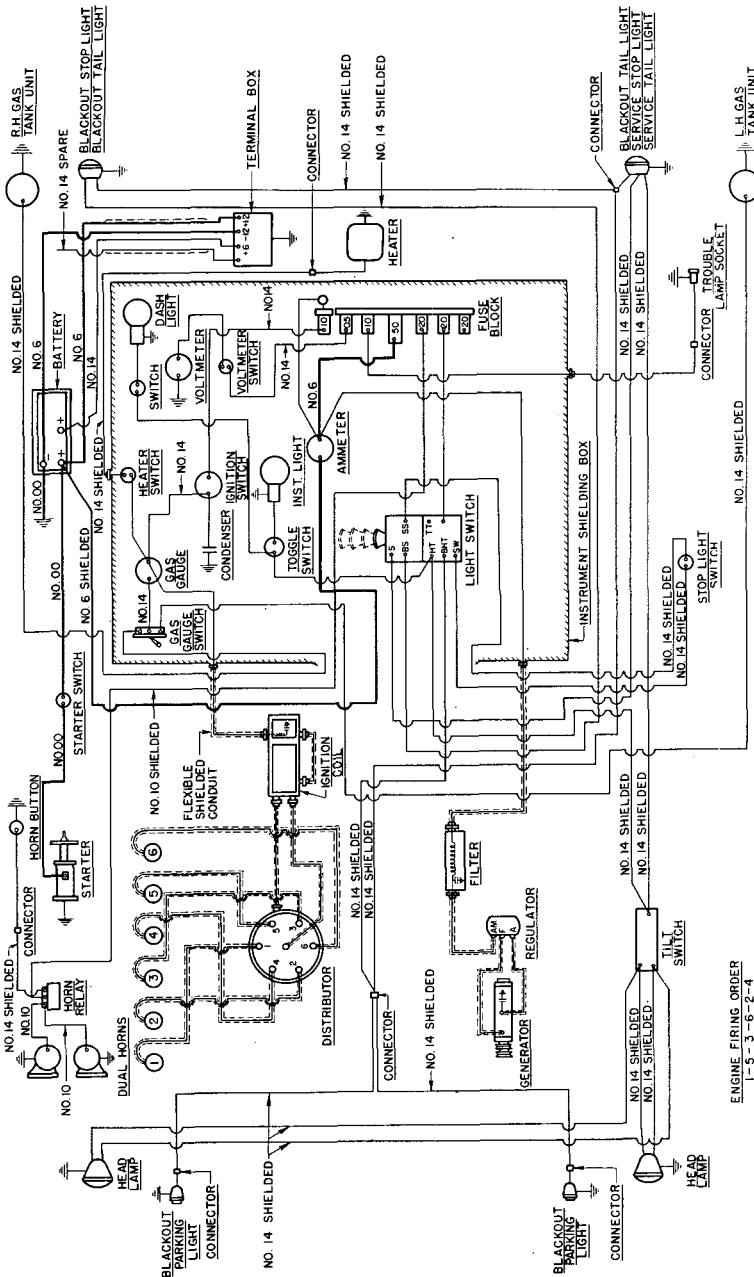

RA PD 41919

Figure 64 — Wiring Diagram - Gasoline Engine Vehicles

**ELECTRICAL SYSTEM AND ACCESSORIES
(GASOLINE ENGINE POWERED VEHICLES)**

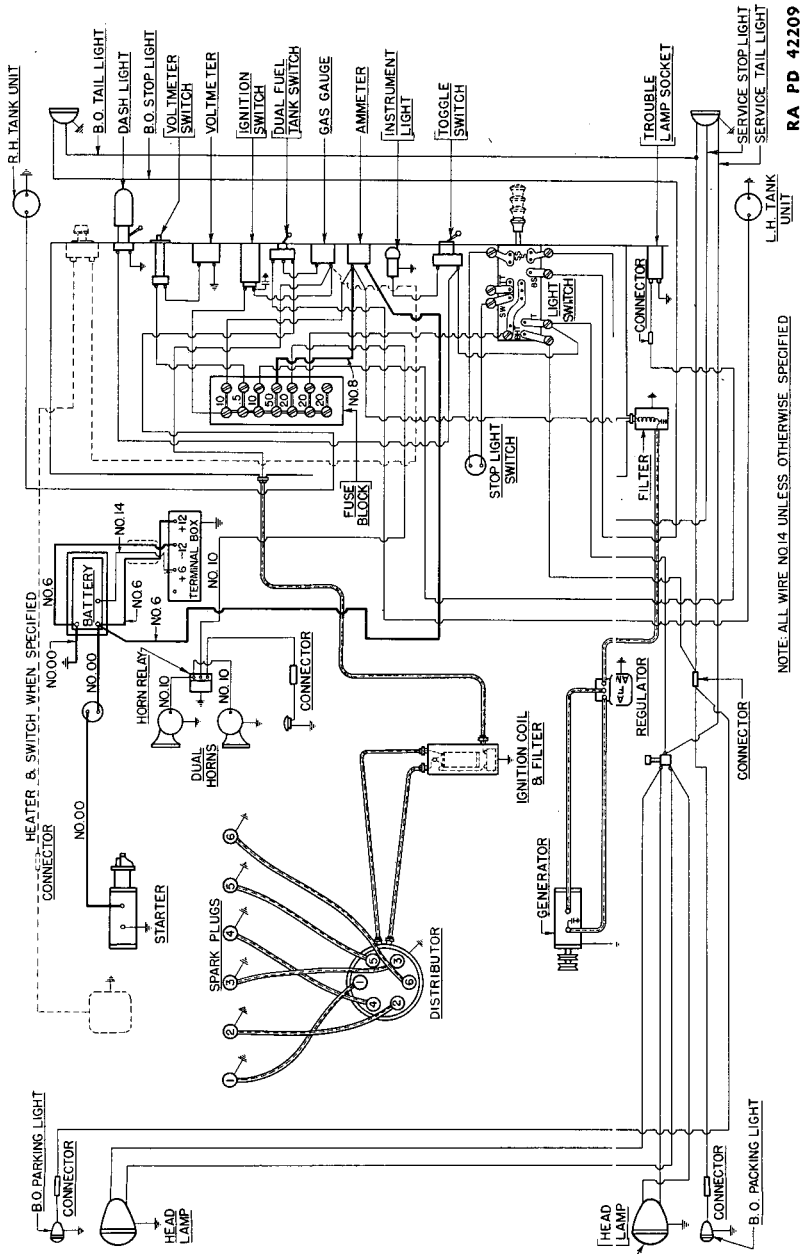

Figure 65 — Wiring Diagram - Gasoline Engine Vehicles - Latest Design

SCOUT CAR M3A1

mately 12 volts. An excessive drop (more than 2-3 volts) in voltage under heavy load (starting motor engaged for example) will indicate that something is wrong with the battery or its connections.

b. Battery Fluid. The battery fluid (electrolyte) should be checked at regular intervals and maintained to a level of $\frac{1}{2}$ inch above the plates. Clean, distilled water should be used when available. In cold weather, water should be added just before the vehicle is to be operated, to assure thorough mixing, and avoid danger of freezing. The specific gravity should be maintained above 1.250. A reading of 1.270 to 1.290 indicates a fully-charged battery when the temperature of the battery fluid is 80 F. A reading of 1.220 indicates a half-charged battery, and a reading of 1.150 or lower indicates complete discharge. Tests with a battery hydrometer made immediately after water has been added will not register correctly. Tests should be made before water is added, or after battery has been on charge or in use for a few hours.

c. Maintenance.

(1) **CLEANING.** The battery and battery compartment must be kept clean and dry and the vent plugs tightened, although the breather holes in the latter must be kept open. If the electrolyte is spilled or any parts are damp with acid, a solution of ordinary baking soda (1 lb soda to 1 gal water) or weak ammonia should be applied and the surfaces should then be rinsed with fresh water and dried. No cleaning solution should be allowed to enter a cell. Cleaning cloths contaminated with acid should be discarded, and special care must be exercised to keep them away from materiel.

(2) **CONNECTIONS.** Cables and terminals should be kept tight, or the proper connections cannot be maintained. Scrape clean with a coarse wire brush, and then wash the surface with hot water and soap. Coat terminals with **GREASE**, general purpose, to prevent formation of corrosion.

(3) **CHARGING.** Provision is made on the vehicle for normal charging in service from a voltage-regulated, battery-charging, direct-current generator, as explained in the following paragraphs. Should the battery become discharged through overloading or neglect, it should be recharged by a standard auxiliary battery charger.

d. Temperature Effects. Check the battery for heating in warm weather. If the battery feels more than blood warm to the touch (approximately 100 F), check for short circuits and excessive charging.

(1) **HOT REGIONS.** In tropical regions, danger of overheating is much greater than in cooler climates. The battery, when fully charged, should have a gravity of 1.225 under such conditions.

ELECTRICAL SYSTEM AND ACCESSORIES (GASOLINE ENGINE POWERED VEHICLES)

(2) **COLD REGIONS.** Unless a full charge is maintained, the solution may freeze and cause damage to plates and containers to such an extent as to destroy the battery for all practicable purposes. A completely discharged battery may freeze at approximately 20 F.

(3) **HYDROMETER CORRECTION CHART** (fig. 66). To determine the actual specific gravity of the electrolyte, it is necessary to check the temperature of the solution with a thermometer. If the temperature is above or below 80 F it will be necessary to make an allowance to determine the actual specific gravity. The electrolyte expands when warm, so that the same volume will weigh less than it does at normal temperature. This results in hydrometer readings which are lower than the true reading at 80 F. The reverse is also true so that readings taken with electrolyte temperature below 80 F will be greater than the true reading at 80 F. The correction chart (fig. 66) shows the corrections in readings to be used for different electrolyte temperatures to obtain a true hydrometer reading. For example, when the specific gravity, as shown by the hydrometer reading is 1.290 and the temperature of the electrolyte is 60 F, it will be necessary to subtract eight points or 0.008 from 1.290 which gives 1.282 as the actual specific gravity. If the hydrometer reading shows 1.270, at a temperature of 110 F it will be necessary to add 12 points or 0.012 to the reading which gives 1.282 as the actual specific gravity.

(4) **STORAGE.** Batteries tend to "self-discharge" while standing idle. Batteries kept in hot surroundings will discharge much faster than those stored in a cool place. Allowing batteries to stand in a discharged or partially charged state may cause the positive plates to buckle in service.

e. Removal.

Pliers

Wrench, open-end, $\frac{9}{16}$ -in.

Wrench, socket, $\frac{9}{16}$ -in., on

$\frac{1}{2}$ -in. drive

Remove the three bolts and washers from the battery cover and lift off the cover (fig. 67). Remove the four bolts and lock washers from the battery cover side plate and lift off the side plate. Free the battery cables and lift them off with pliers (fig. 68). Remove the ground or negative lead first to prevent the possibility of destructive arcs if metal tools accidentally short circuit a positive terminal to the compartment or frame. Wrap tape around the lead terminals as shown in figure 69. Remove the two nuts (one on each side of the battery) and take out the two hook bolts (fig. 70). Unscrew the wing nuts, as shown in figure 71, and remove the radio connections. With a man at each end, lift the battery out of its compartment.

SCOUT CAR M3A1

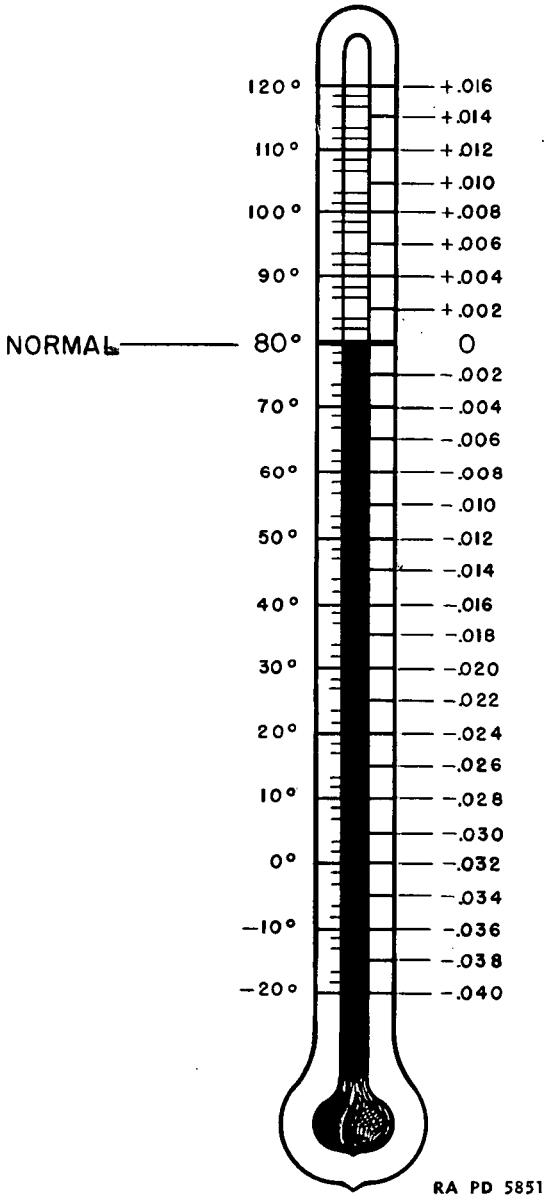

Figure 66 — Hydrometer Correction Chart

**ELECTRICAL SYSTEM AND ACCESSORIES
(GASOLINE ENGINE POWERED VEHICLES)**

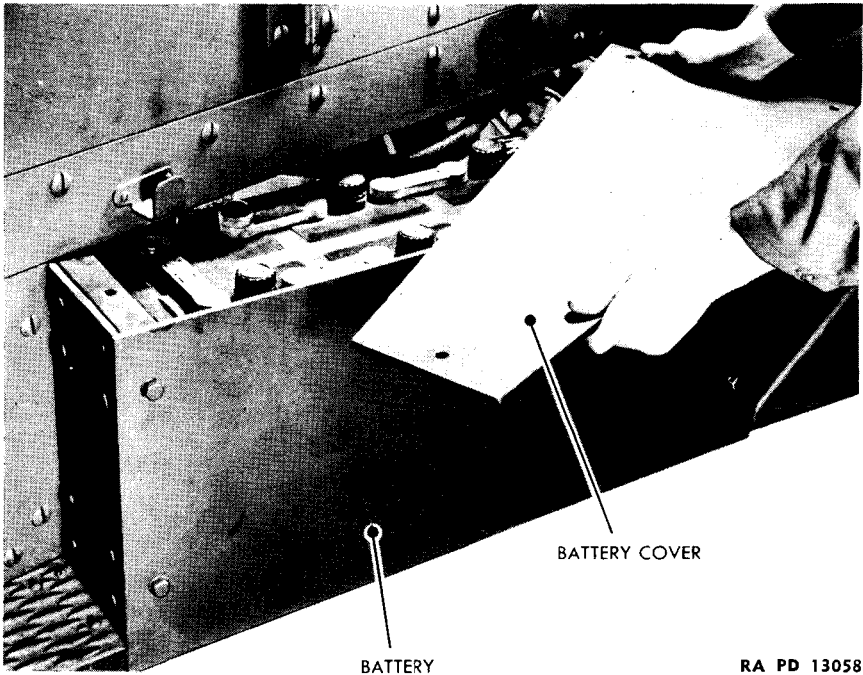

Figure 67 — Removing Battery Compartment Cover

f. Installation.

Wrench, open-end, $\frac{9}{16}$ -in.

Wrench, socket, $\frac{9}{16}$ -in., on
 $\frac{1}{2}$ -in. drive.

Place the battery in position in the battery compartment. Install the radio connections on the ears of the battery terminals, attaching them by means of the wing nuts (fig. 71). Install the hook bolt at each end of the battery, with the hook end through the hole in the bracket of the compartment, and screw the nut on the straight end, as shown in figure 70. Remove the tape from the positive battery cable, and install the cable on the inner terminal of the battery. Then remove the tape from the negative cable and install the cable on the outer battery terminal. Install the side plate and cover plate (fig. 67).

100. STARTING MOTOR.

a. Description. The starter or cranking motor is a heavy-duty, four-brush type, and is secured to the flywheel housing on the right side of the engine by means of a three stud flange mounting. Power is transmitted to the engine flywheel ring gear through a right-hand Bendix

SCOUT CAR M3A1

drive. A removable cover band around the field frame permits inspection of the commutator and brush connections.

b. Maintenance and Adjustments. The cover band should be removed periodically and the brushes and commutator inspected. If brushes wear with excessive rapidity, check for excessive brush spring tension, roughness, or high mica of the commutator. Tension of the springs should be maintained at 42 to 53 ounces. Brushes must seat properly and not bind. Connections at the starting motor must be kept tight and clean. Check for loosened flange mounting nuts, and oil seepage into the drive from the flywheel ring gear.

c. Trouble Shooting. If the cranking motor does not develop rated torque and cranks the engine slowly or not at all, check the battery, battery terminals and connection, ground cable and battery to cranking motor cable. The starter switch should be checked for burned contacts. Check the brushes and commutator. Clean the commutator with PAPER, sand, No. 00 (never use emery cloth). If such an inspection fails to locate the trouble, replace the motor.

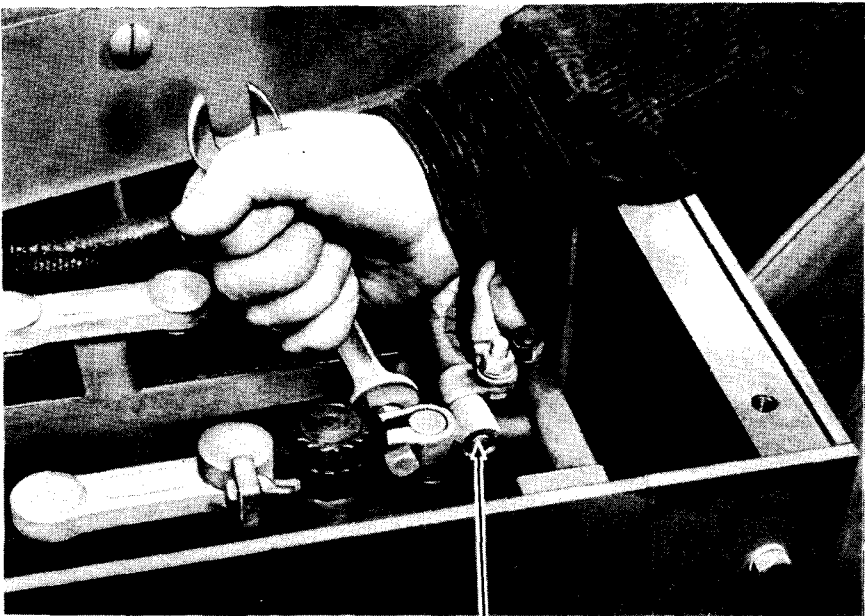

RA PD 13013

BATTERY NEGATIVE
TERMINAL

Figure 68 — Disconnecting Battery Negative Lead

**ELECTRICAL SYSTEM AND ACCESSORIES
(GASOLINE ENGINE POWERED VEHICLES)**

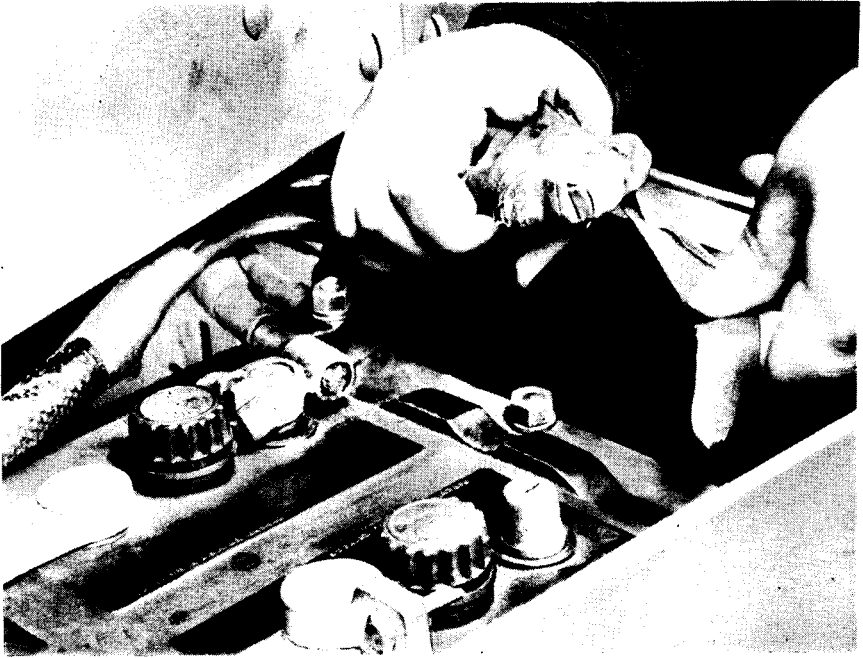

RA PD 13079

Figure 69 — Insulating Battery Negative Lead Terminal

d. Removal (fig. 73).

Wrench, open-end, $\frac{9}{16}$ -in.

Disconnect lead at starting motor, remove the three mounting nuts and lock washers and remove the motor.

e. Installation.

Wrench, open-end, $\frac{9}{16}$ -in.

To install, place the starting motor on the mounting studs, install the lock washers and nuts, and connect lead to the starting motor.

101. GENERATOR.

a. Description. The generator is a heavy-duty, four-brush, shunt-wound unit, and is belt driven clockwise from the engine crankshaft in connection with the radiator fan pulley. The terminals are shielded to reduce radio interference. Maximum cold output under control of the regulator is 55 amperes. A removable cover band around the field frame permits the inspection of the commutator and brush connections. The

SCOUT CAR M3A1

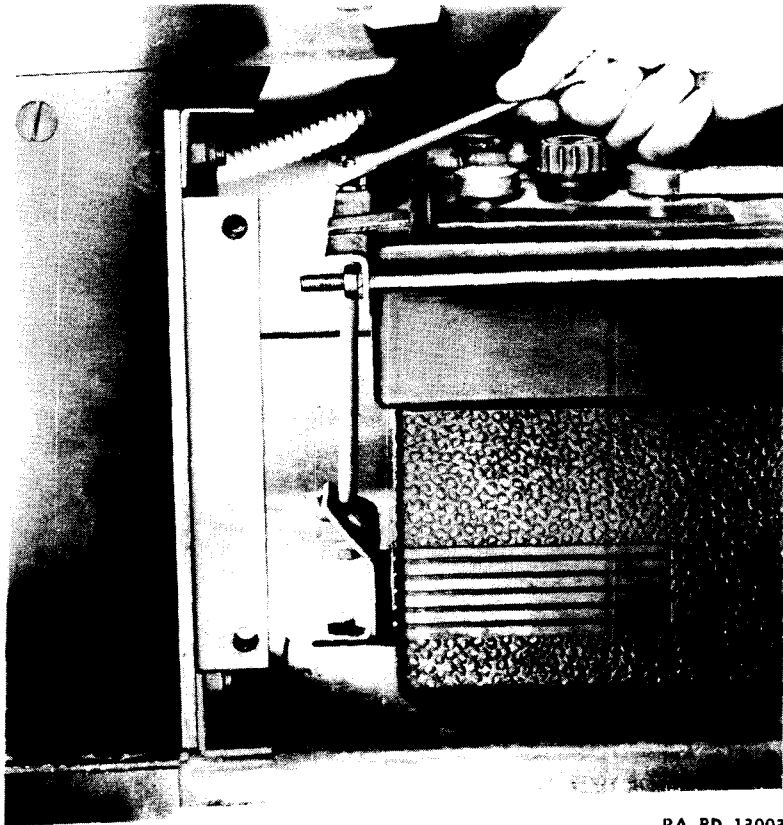

RA PD 13003

Figure 70 — Battery Holding Bracket Removal

latest type generator is equipped with a radio shielding cover but the generator is serviced in the same manner as described in this paragraph.

b. Maintenance and Adjustments. The cover band should be removed and the commutator and brushes inspected at regular intervals. If the commutator is dirty, it may be cleaned with PAPER, sand, No. 00 (never use emery cloth). Blow out dust. Replace worn brushes and examine all brushes for proper seating, especially if excessive sparking is observed under heavy load with a smooth commutator. Check brush spring tension which should be approximately 65 ounces. Terminal connections must be tight, and shields must be closed and secured properly. Check for loosened bracket mountings.

c. Trouble Shooting.

(1) No OUTPUT. Remove cover band and check for sticking or worn

**ELECTRICAL SYSTEM AND ACCESSORIES
(GASOLINE ENGINE POWERED VEHICLES)**

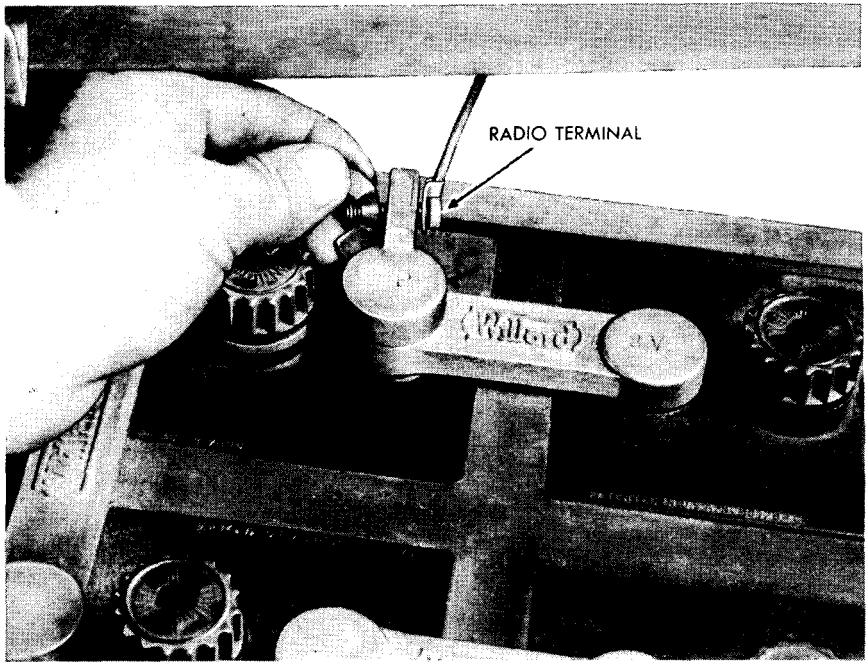

RA PD 13004

Figure 71 — Disconnecting Radio Terminal from Battery

brushes and burned commutator bars. If brushes are making good contact and the commutator looks satisfactory, further servicing is probably beyond the scope of facilities available (unless voltage regulator replacement corrects situation), and replacement of the generator is necessary.

(2) **UNSTEADY OR LOW OUTPUT.** First check the battery condition with hydrometer. If battery is fully charged, unsteady or low output indicates normal functioning of generator because of voltage regulation. Check for drive belt tension, brush spring tension, sticking brushes, and dirty commutator, and make necessary corrections.

(3) **EXCESSIVE OUTPUT.** High output, suddenly developed, usually results from trouble in voltage regulator unit. Check battery condition with hydrometer. If battery is discharged, high output is probably normal.

(4) **NOISE.** Check for loose pulley and mounting details, lack of lubrication, improperly seated brushes.

SCOUT CAR M3A1

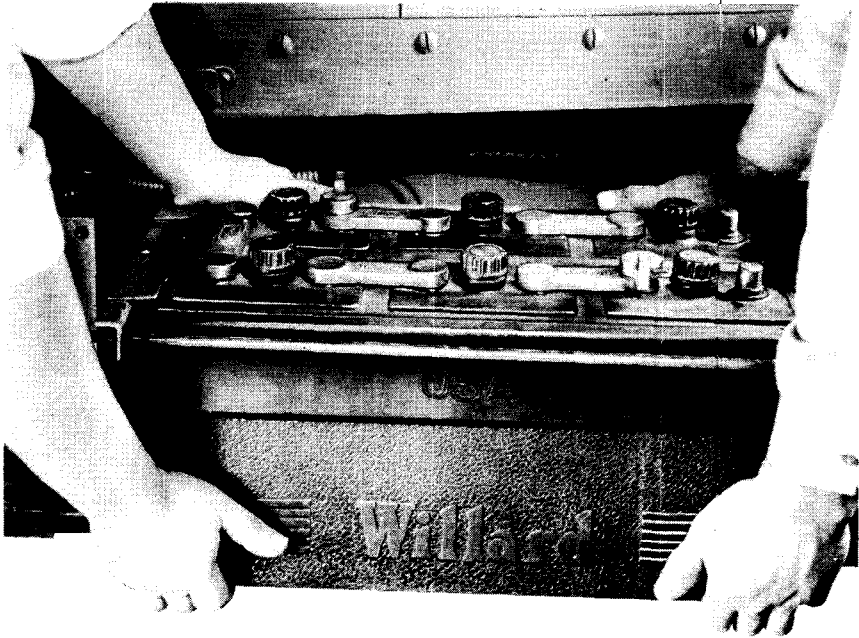

RA PD 13001

Figure 72 — Removing Battery

d. Removal of Generator.

- | | |
|--------------------------------------|-------------------------------------|
| Handle, ratchet | Wrench, socket, $\frac{9}{16}$ -in. |
| Pliers | Wrench, socket, $\frac{3}{4}$ -in. |
| Screwdriver | Wrench, socket, thin wall, |
| Wrench, open-end, $\frac{5}{8}$ -in. | $\frac{3}{8}$ -in. |

(1) DISCONNECT ARMATURE TERMINAL.

- | | |
|--------|---|
| Pliers | Wrench, socket, $\frac{9}{16}$ -in. and
ratchet handle |
|--------|---|

Use pliers to unscrew the condenser assembly on the armature terminal (fig. 74). Remove the radio shielding nut from the generator armature terminal (fig. 75). Using a $\frac{9}{16}$ -inch socket wrench and ratchet handle, remove the upper terminal nut and plain washer and take out the cable (fig. 76).

(2) DISCONNECT FIELD TERMINAL.

- | | |
|--------------------------------------|--|
| Screwdriver | Wrench, socket, thin wall $\frac{3}{8}$ -in. |
| Wrench, open-end, $\frac{5}{8}$ -in. | |

Using a screwdriver, remove the screw plug or cover from the field terminal (fig. 77). A special $\frac{1}{4}$ -inch drive with a $\frac{3}{8}$ -inch thin wall socket

**ELECTRICAL SYSTEM AND ACCESSORIES
(GASOLINE ENGINE POWERED VEHICLES)**

STARTING MOTOR
ADAPTER

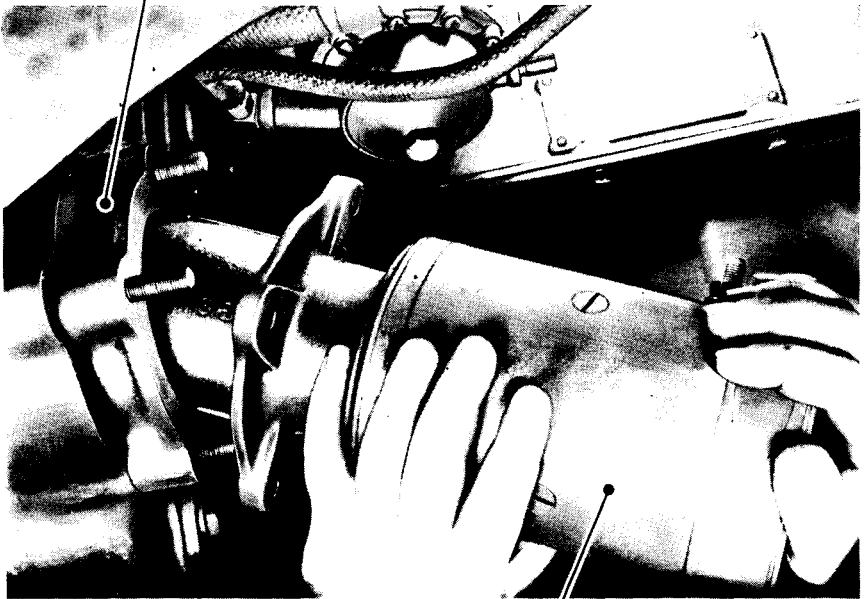

STARTING MOTOR
ASSEMBLY

RA PD 13008

Figure 73 — Starting Motor Replacement - (Gasoline Engine)

wrench is necessary to remove the field terminal nut (fig. 78). Insert the socket as shown in figure 79 and remove the nut. Disconnect the terminal wire and pull the terminal out of the housing assembly.

(3) REMOVE THE GENERATOR AND BRACKET ASSEMBLY.

Handle, ratchet

Wrench, socket, $\frac{3}{4}$ -in.

Remove the distributor cap and radio shielding to provide more convenient access to the generator (fig. 80). Remove the three cap screws and lock washers that hold the generator frame mounting bracket to engine block (fig. 81). Be sure to get a firm grip on the generator as it is heavy and comes away easily after the cap screws have been removed. Tilt the generator to remove the fan belts and lift out generator and bracket assembly (fig. 82).

e. Installation of Generator.

Handle, ratchet

Wrench, socket, $\frac{9}{16}$ -in.

Pliers

Wrench, socket, $\frac{3}{4}$ -in.

Screwdriver

Wrench, socket, thin wall,

Wrench, open-end, $\frac{5}{8}$ -in.

$\frac{3}{8}$ -in.

SCOUT CAR M3A1

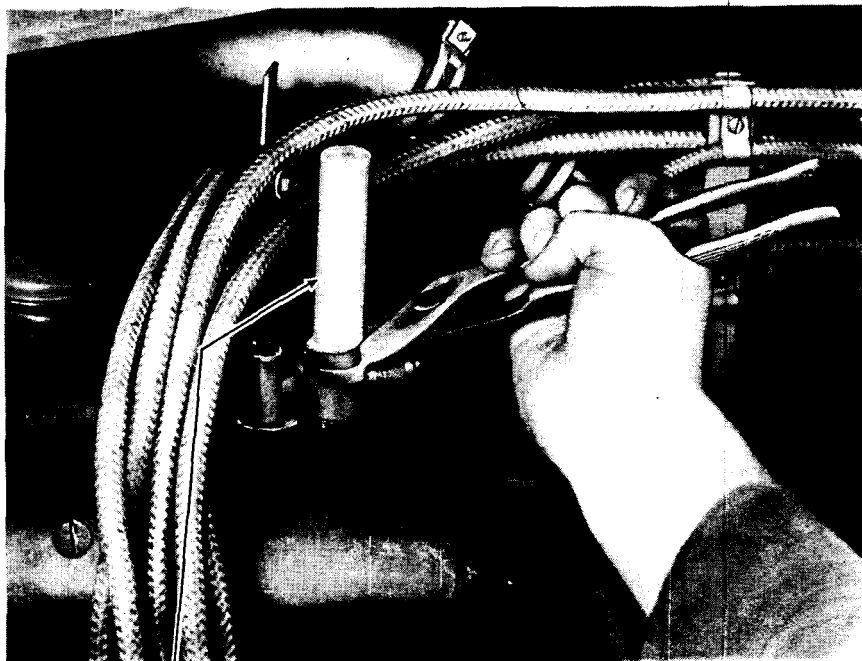

CONDENSER

RA PD 13126

**Figure 74 — Removing Generator Armature Condenser -
(Gasoline Engine)**

(1) INSTALL GENERATOR ASSEMBLY.

Handle, ratchet

Wrench, socket, $\frac{3}{4}$ -in.

With fan belt adjusting screw in its slack position, place fan belts on pulley. Place generator in position and install the three cap screws and lock washers.

(2) CONNECT ARMATURE CONDUIT TO GENERATOR.

Pliers

Wrench, socket, $\frac{9}{16}$ -in.

Remove upper hexagon nut and lock washer from generator frame terminal post. Insert terminal through shield housing; place it on armature post and secure with washer and nut. Fasten conduit to housing with nut (fig. 75). Install condenser in housing (fig. 74).

(3) CONNECT FIELD CONDUIT TO GENERATOR.

Screwdriver

Wrench, socket, thin wall,

Wrench, open-end, $\frac{5}{8}$ -in.

$\frac{3}{8}$ -in.

Remove hexagon nut and lock washer from generator frame terminal stud post. Insert terminal of wire through shield housing, place it on

**ELECTRICAL SYSTEM AND ACCESSORIES
(GASOLINE ENGINE POWERED VEHICLES)**

field post, and secure with lock washer and nut (fig. 79). Install field terminal housing plug and fasten conduit to housing with hexagon coupling nut (fig. 77).

102. VOLTAGE REGULATOR AND FILTER.

a. Description. The generator output to the electrical system is controlled automatically by a factory-tested sealed control device called the voltage regulator, which is mounted to the left on the engine side of the dash. The regulator consists of three separate and distinct elements; a cut-out or reverse current relay, the voltage regulator relay, and a current limiting relay, all of which are mounted on the same base under a common cover and shielded.

(1) **CUT-OUT RELAY.** The function of this automatic switch is to close the circuit between the generator armature and the battery when the generator is operating at a speed sufficient to develop voltage (approx. 13.5 volts) in excess of the system to which it is connected. It also opens

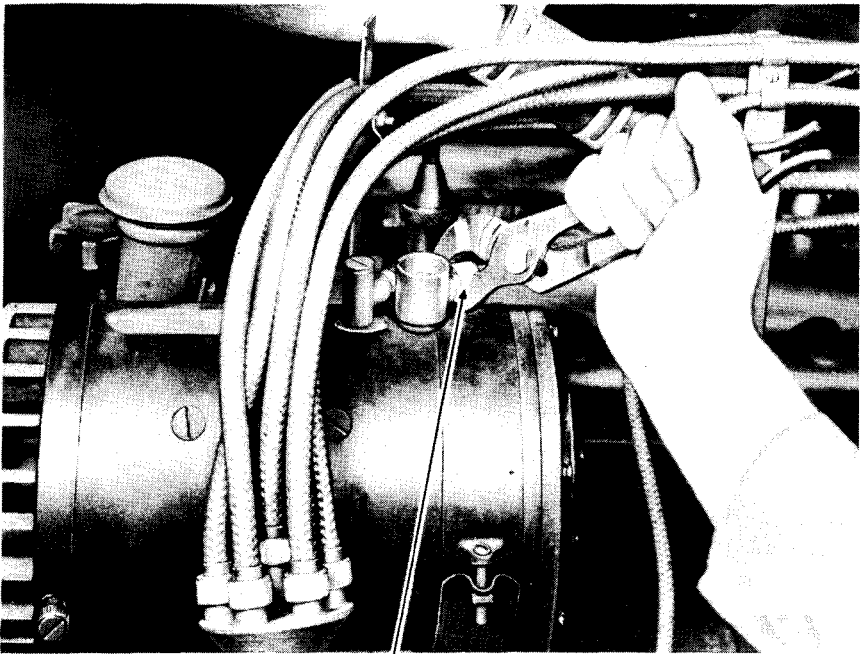

RADIO SHIELDING COUPLING NUT

RA PD 13128

Figure 75 — Removing Radio Shielding Nut on Generator Armature Terminal

SCOUT CAR M3A1

the circuit when the generator is at a standstill or low speed, and thus prevents discharge of the battery through the generator.

(2) **VOLTAGE REGULATOR RELAY.** The function of this type unit is to control the generator field, and prevent the generated voltage from exceeding a predetermined value (approx. 15.0 volts on open circuit). A constant voltage is maintained and, at the same time, limited to protect the system equipment from excessive voltage surges. The regulator cannot increase the generator output beyond the designed maximum.

(3) **CURRENT REGULATOR RELAY.** This unit is similar in construction to the voltage regulator relay, but its action depends on the load requirements rather than on the generated voltage. It functions to protect the generator from an excessive current output by opening the circuit at a predetermined circuit value (55 amperes). The normal current output varies in proportion to the state of battery charge and the requirements of the vehicle electrical accessories.

b. Removal of Regulator.

Pliers, channellock

Screwdriver

Wrench, open-end, 1/2-in.

Wrench, open-end, 5/8-in.

Wrench, socket, 1/2-in.

GENERATOR

SOCKET WRENCH

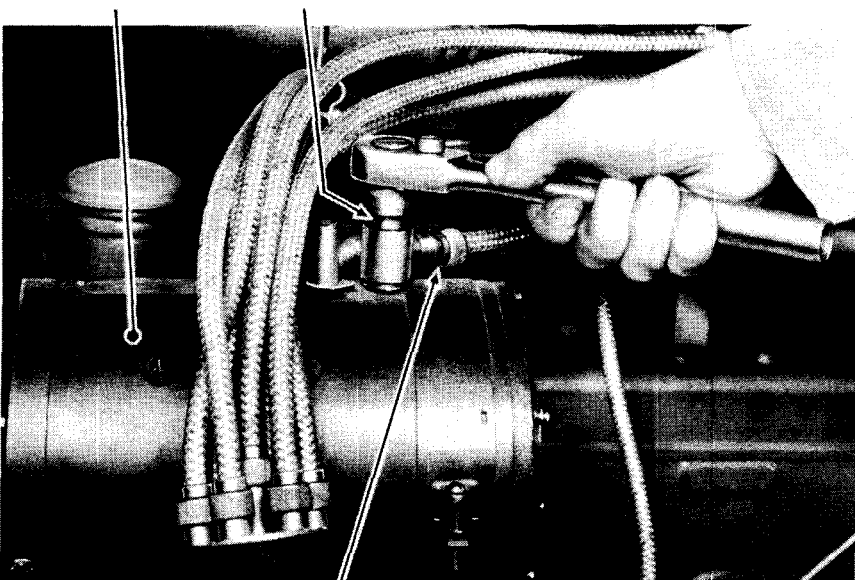

ARMATURE
TERMINAL

RA PD 13025

**Figure 76 — Removing Generator Armature Terminal Nut -
(Gasoline Engine)**

**ELECTRICAL SYSTEM AND ACCESSORIES
(GASOLINE ENGINE POWERED VEHICLES)**

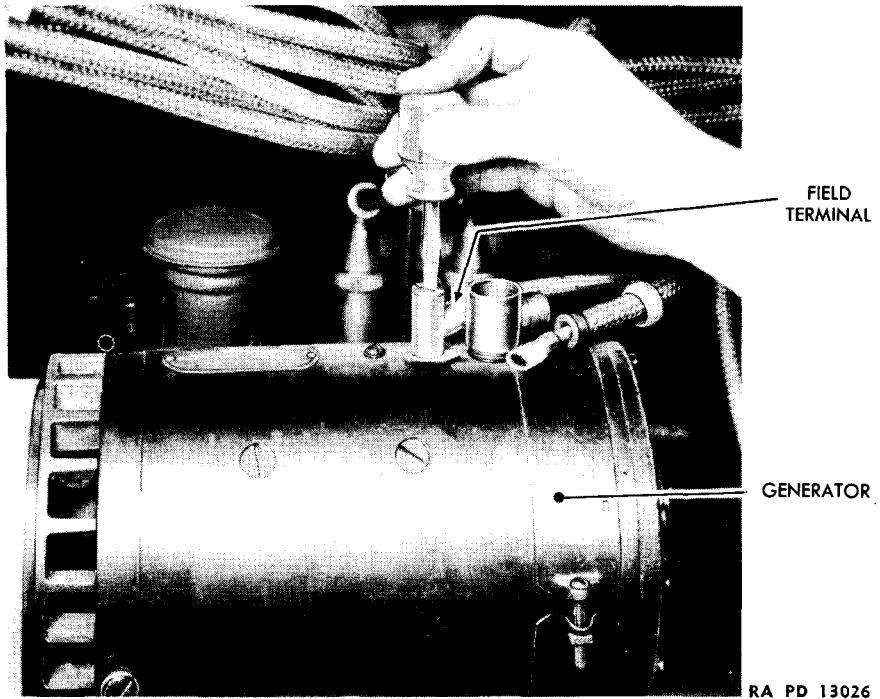

**Figure 77 — Removing Generator Field Terminal Cover -
(Gasoline Engine)**

(1) NEGATIVE CABLE.

Pliers, channellock

Disconnect negative cable at battery negative post.

(2) REMOVE SHIELD COVER.

Screwdriver

Remove screws, lock washers and plain washers holding terminal shield cover and lift off cover.

(3) DISCONNECT GENERATOR AND FILTER CONDUITS AT REGULATOR.

Pliers, channellock

Wrench, open-end, $\frac{5}{8}$ -in.

Screwdriver

Remove terminal holding screws and lock washers to disconnect wires (fig. 83). Loosen conduit coupling nuts and pull away generator and filter conduits, with wire assemblies. **NOTE:** Care should be taken when removing filter terminal unless battery has been disconnected.

SCOUT CAR M3A1

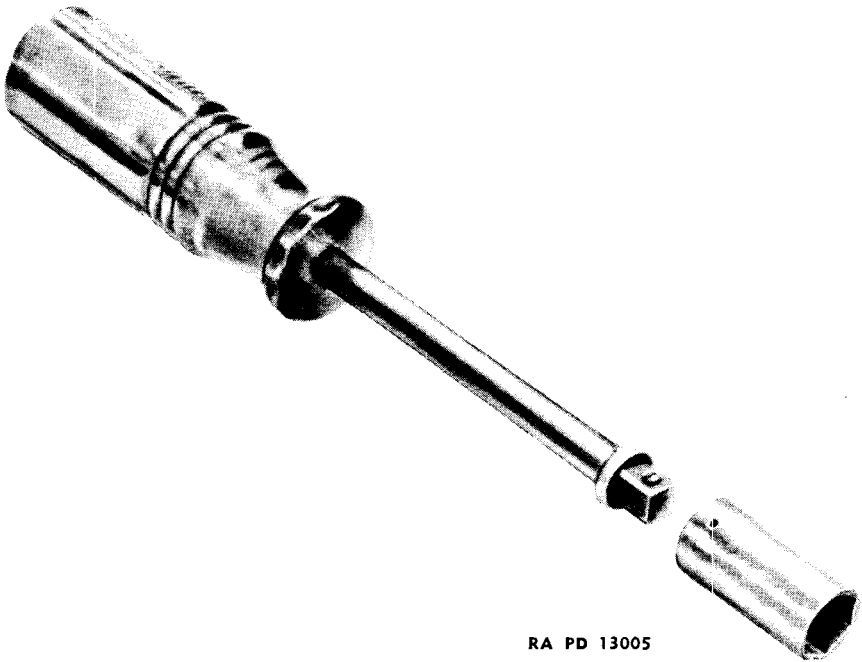

RA PD 13005

Figure 78 — Special Tool for Removal of Field Terminal Hexagon Nut

(4) REMOVE REGULATOR AND SHIELD ASSEMBLY.

Wrench, open-end, $\frac{1}{2}$ -in.

Wrench, socket, $\frac{1}{2}$ -in.

Remove nuts, lock washers and cap screws holding regulator assembly and shield to dash and lift off regulator assembly and shield. Separate shield from regulator assembly.

c. Installation of Regulator.

Pliers, channellock

Wrench, open-end, $\frac{5}{8}$ -in.

Screwdriver

Wrench, socket, $\frac{1}{2}$ -in.

Wrench, open-end, $\frac{1}{2}$ -in.

(1) INSTALL REGULATOR ASSEMBLY AND SHIELD ON VEHICLE.

Wrench, open-end, $\frac{1}{2}$ -in.

Wrench, socket, $\frac{1}{2}$ -in.

Place regulator assembly in position on dash, place shield on regulator base feet and secure both to dash with cap screws, lock washers, and nuts.

ELECTRICAL SYSTEM AND ACCESSORIES (GASOLINE ENGINE POWERED VEHICLES)

(2) CONNECT GENERATOR FIELD AND ARMATURE LEADS AND FILTER LEAD TO REGULATOR.

Pliers, channellock
Screwdriver

Wrench, open-end, $\frac{5}{8}$ -in.

Insert leads through shield and connect them to respective regulator terminals with lock washer and fillister head machine screws. Secure generator and filter conduits to shield with conduit coupling nuts.

(3) INSTALL SHIELD COVER.

Screwdriver

Secure cover to shield with plain washers, lock washers, and machine screws at corners.

(4) NEGATIVE BATTERY CABLE.

Pliers, channellock

Reconnect negative cable to battery terminal post. NOTE: After any check or replacement of the regulator or generator, *always* connect

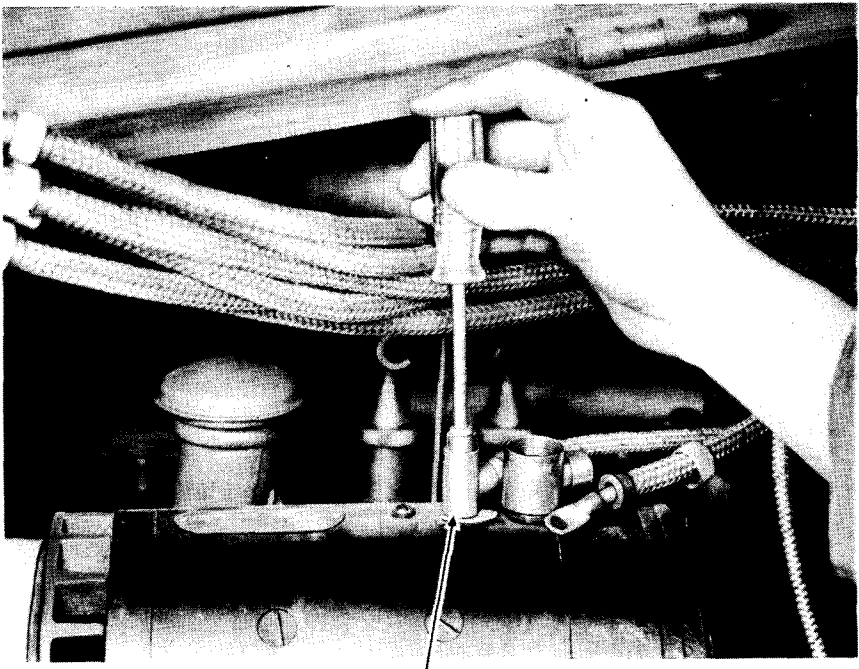

FIELD TERMINAL

RA PD 13129

**Figure 79 — Removing Generator Field Terminal Nut -
(Gasoline Engine)**

SCOUT CAR M3A1

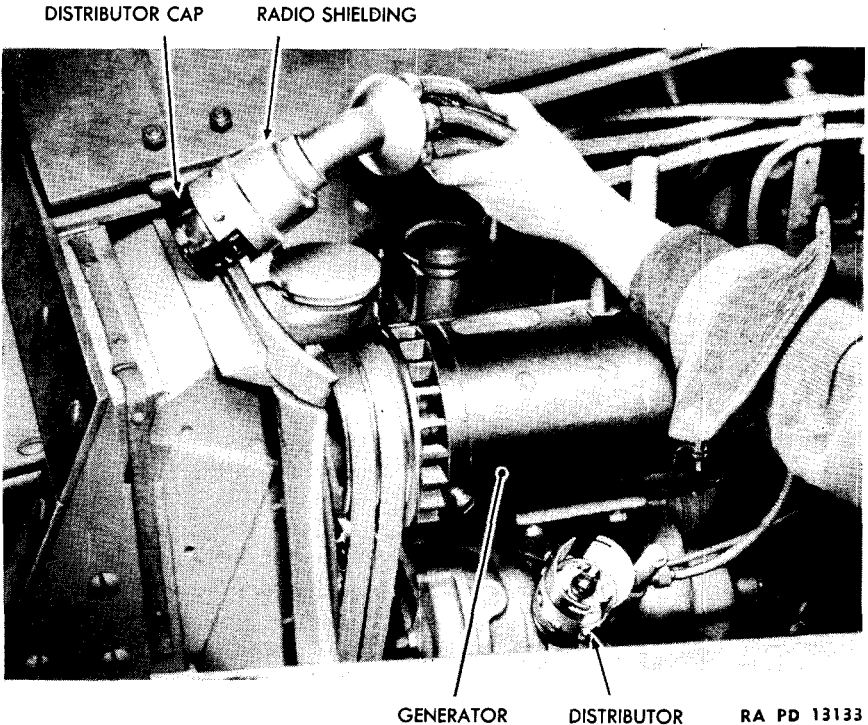

Figure 80 — Removing Distributor Cap and Radio Shielding - (Gasoline Engine)

a jumper lead momentarily between the armature and battery terminals of the regulator after it is reconnected, but before the engine is started. This will correctly polarize the generator with the battery it is to charge.

d. Failure in Operation. In the event of an emergency involving failure of the voltage regulator, disconnect the field terminal lead at the generator. This prevents the generator from developing any voltage when it is driven. The best procedure, if material is available, is to replace a voltage regulator when there is any indication of trouble that cannot be simply determined and corrected. Detailed testing recommendations for this type of equipment are not within the scope of this manual. If contacts of the regulator relays tend to seal, the generator has no protection electrically other than to have its field and armature terminals disconnected. The generator cannot be removed without depriving the fan of its driving belts since the same belts drive both units.

e. Filter.

(1) The filter is used in the electrical circuit to reduce radio interference, and is located under the dash board. Replace the unit if elec-

**ELECTRICAL SYSTEM AND ACCESSORIES
(GASOLINE ENGINE POWERED VEHICLES)**

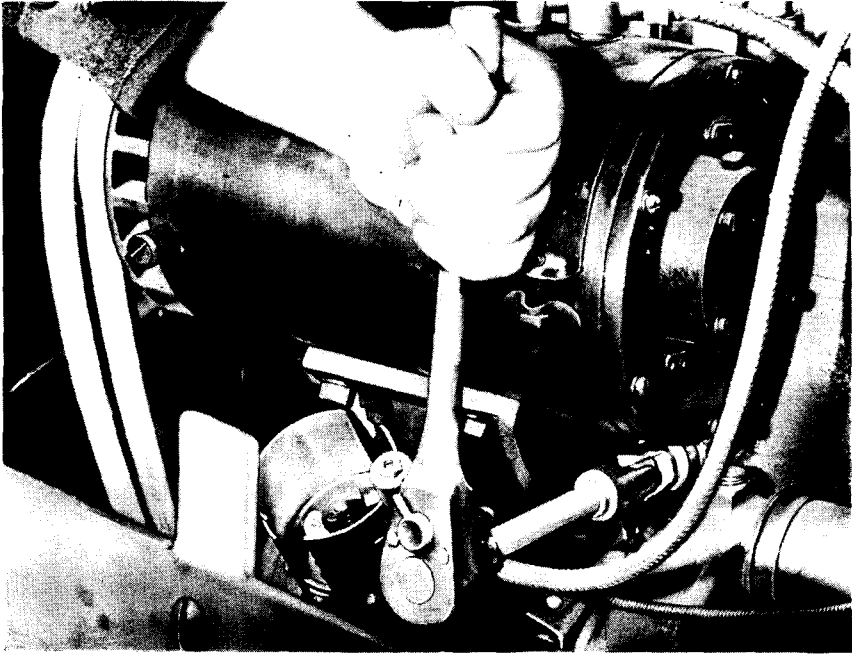

RA PD 13127

**Figure 81 — Removing Generator Bracket Cap Screw -
(Gasoline Engine)**

trical trouble or radio interference have shown it to be defective. To replace the unit, disconnect the leads and remove the cap screws from the bracket holding the unit to the dash board.

(2) The radio interference filter used on early model scout cars was of cylindrical shape and was set at 15.5 volts when the vehicle was equipped with radio, and at 15 volts when not radio-equipped. If battery overcharge was experienced, the voltage setting could be made as low as 14.5 volts.

(3) The new type rectangular-shaped filter should have a voltage regulator setting of not more than 15.0 volts for radio-equipped cars. Battery overcharge correction can be made by having the regulator set as low as 14.1 volts.

103. IGNITION COIL.

a. Description. The ignition coil converts low voltage primary current, from generator or battery, to a higher voltage which is strong enough to jump the spark plug gaps. A shielding box on the engine side

SCOUT CAR M3A1

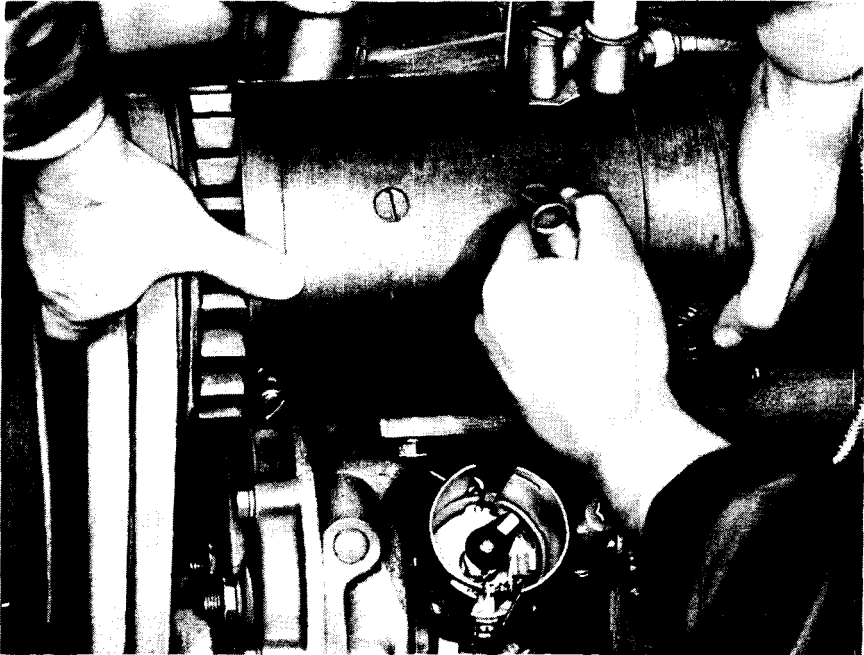

RA PD 13134

Figure 82 — Removal of Generator - (Gasoline Engine)

of the dash encloses the coil. The center top high-tension terminal is for the cable connection to the distributor cap. The negative low-tension terminal is for connection to the distributor points. The positive low-tension terminal is for connection to the filter coil.

b. Trouble Shooting and Maintenance. If in doubt as to coil's performance, substitute a unit known to be satisfactory and check difference in operation, or if time permits, proceed as in paragraph 108 to locate the trouble. Terminals must be kept tight, clean, and dry. Figure 84 shows the installation of the latest design of the voltage regulator and the ignition coil.

c. Removal of Assembly (fig. 85).

Screwdriver

Wrench, open-end, $\frac{5}{16}$ -in.

Wrench, open-end, $\frac{3}{8}$ -in.

Wrench, open-end, $\frac{7}{16}$ -in.

Wrench, open-end, $\frac{5}{8}$ -in.

Wrench, open-end, $\frac{3}{4}$ -in.

(1) REMOVE SHIELD ASSEMBLY FROM DASH.

Wrench, open-end, $\frac{7}{16}$ -in.

Wrench, open-end, $\frac{5}{8}$ -in.

Wrench, open-end, $\frac{3}{4}$ -in.

**ELECTRICAL SYSTEM AND ACCESSORIES
(GASOLINE ENGINE POWERED VEHICLES)**

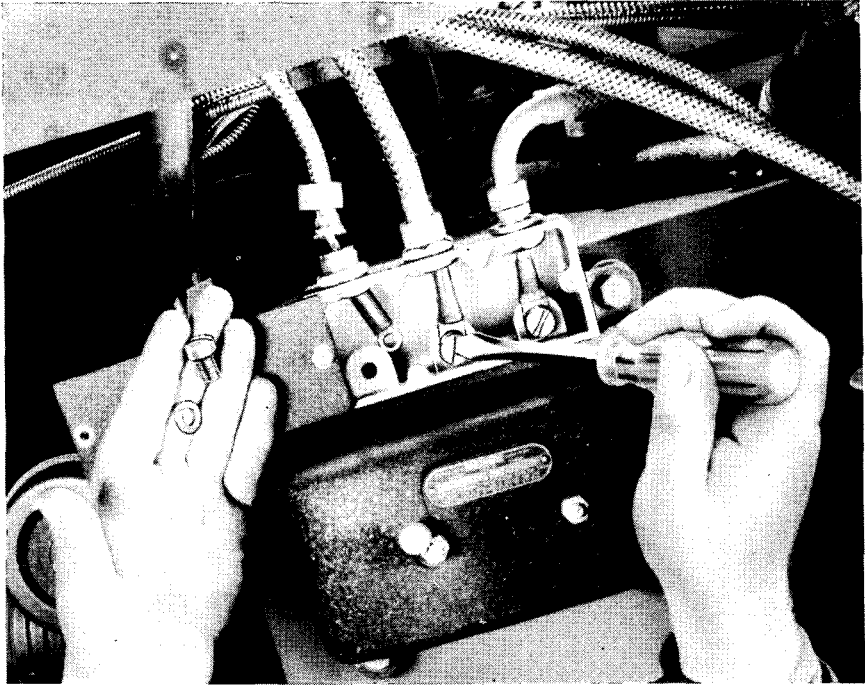

RA PD 10963

Figure 83 — Disconnecting Regulator Conduit with Wire Assembly

Remove ignition switch conduit coupling nut and remove holding nut from shield fitting at rear of dash. Then remove two nuts, plain washers, lock washers and screws, holding shield brackets to dash and pull shield assembly away from dash.

(2) REMOVE SHIELD UPPER CAP.

Screwdriver

Wrench, open-end, $\frac{3}{8}$ -in.

Remove two screws and lock washers holding upper cap to shield assembly. Pull cap away and disconnect distributor wires by pulling high-tension wire from socket in coil and removing nut and lock washer from negative terminal.

(3) REMOVE IGNITION COIL.

Wrench, open-end, $\frac{3}{8}$ -in.

Remove nut and lock washer from positive terminal of coil; pull off lead and slide coil out of shielding assembly.

(4) REMOVE SHIELD ASSEMBLY (fig. 86).

Screwdriver

Wrench, open-end, $\frac{5}{16}$ -in.

SCOUT CAR M3A1

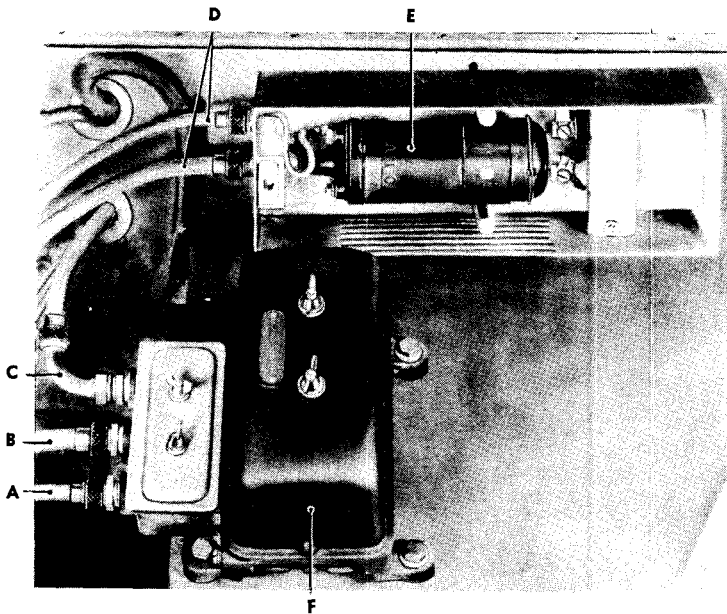

A — TERMINAL A TO GENERATOR D — TO DISTRIBUTOR RA PD 42216
 B — TERMINAL F TO GENERATOR E — IGNITION COIL
 C — TERMINAL AM TO FILTER F — REGULATOR

Figure 84 — Installation of Ignition Coil and Voltage Regulator - (Gasoline Engine)

Remove screws and lock washers holding shield lower cap and pull off cap. Disconnect ignition switch cable at filter coil by removing nut and plain washer from terminal post. Remove shield assembly.

d. Installation of Assembly.

- | | |
|---------------------------------------|---------------------------------------|
| Screwdriver | Wrench, open-end, $\frac{7}{16}$ -in. |
| Wrench, open-end, $\frac{5}{16}$ -in. | Wrench, open-end, $\frac{5}{8}$ -in. |
| Wrench, open-end, $\frac{3}{8}$ -in. | Wrench, open-end, $\frac{3}{4}$ -in. |

(1) CONNECT IGNITION SWITCH CABLE.

- | | |
|-------------|---------------------------------------|
| Screwdriver | Wrench, open-end, $\frac{5}{16}$ -in. |
|-------------|---------------------------------------|

Push ignition cable into shielding at side fitting and fasten in position on filter coil terminal with nut and plain washer. Replace and secure lower shield cover with screws and lock washers.

(2) INSTALL IGNITION COIL.

- | | |
|-------------|--------------------------------------|
| Screwdriver | Wrench, open-end, $\frac{3}{8}$ -in. |
|-------------|--------------------------------------|

Connect distributor cable with nut and lock washer to negative terminal and push high-tension wire into coil center terminal. Slide ignition

**ELECTRICAL SYSTEM AND ACCESSORIES
(GASOLINE ENGINE POWERED VEHICLES)**

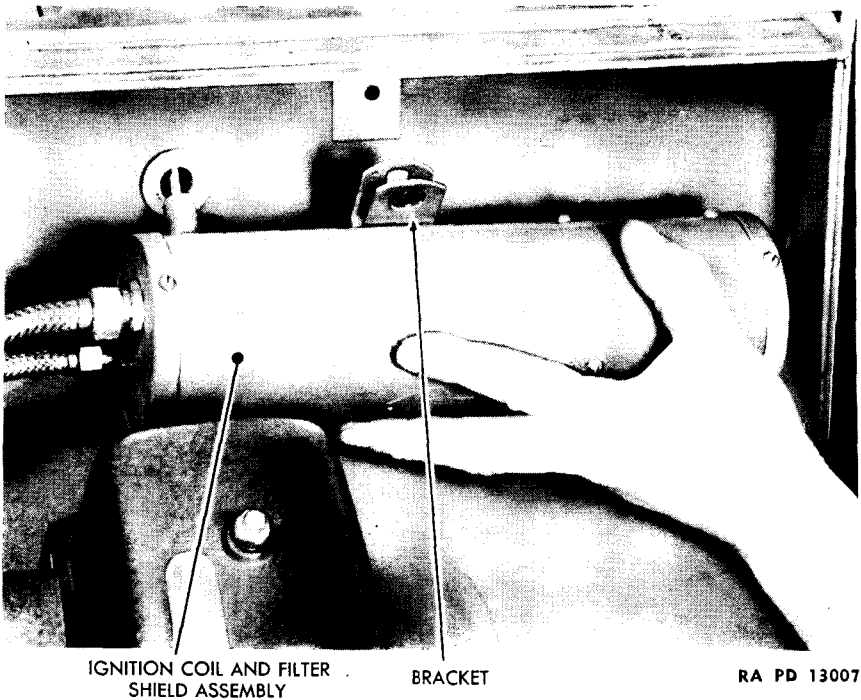

**Figure 85 — Removing Ignition Coil and Shield Assembly -
(Gasoline Engine)**

coil into shield and connect cable from filter coil to positive terminal. Replace upper cap and secure with screws and lock washers.

(3) MOUNT SHIELD ASSEMBLY TO DASH.

Wrench, open-end, $\frac{7}{16}$ -in.

Wrench, open-end, $\frac{3}{4}$ -in.

Wrench, open-end, $\frac{5}{8}$ -in.

Line ignition coil bracket up with shield bracket and place against dash with coupling passing through its hole in dash. Fasten assembly to dash with cap screws, flat washers, lock washers and nuts. Secure coil fitting with hexagon nut and fasten ignition switch conduit with coupling nut.

e. A different type ignition coil and radio shielding capable of withstanding higher operating temperature will be found on vehicles manufactured after June, 1942. This ignition filter and adapter assembly will replace the filter assembly and ignition coil. The assembly includes a different type ignition coil, mounted in a better ventilated radio shielding

SCOUT CAR M3A1

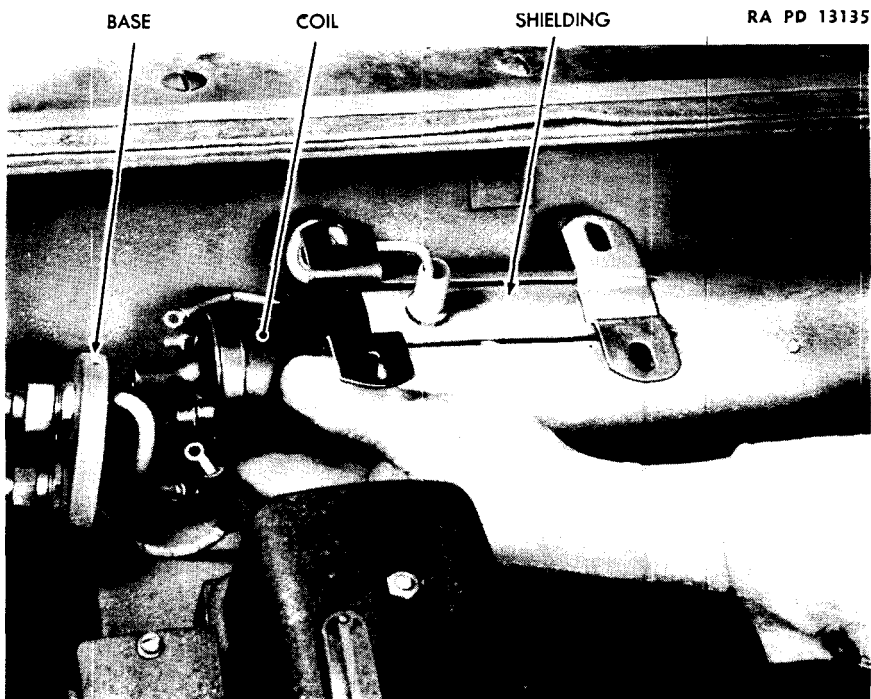

**Figure 86 — Removing the Ignition Coil from the Shielding -
(Gasoline Engine)**

filter unit, together with the necessary adapter which makes it interchangeable with the old coil and radio shielding unit.

(1) To replace, redrill the dash to suit the ventilated radio shielding filter unit.

(2) The new type of ignition coil assembly will be issued upon requisition from the field only after the stock of the old type has been depleted at the supply depots.

104. DISTRIBUTOR.

a. Description. The two types of distributors used vary insofar as the latest design is completely radio-shielded. The maintenance and timing procedures are identical and the two procedures are given for removing and installing the units. The distributor is mounted on the water pump housing, and is driven from a gear which is keyed to the water pump shaft, and held in place by a snap ring. A gear on the end of the distributor shaft, the rotation of which is clockwise as viewed from the top of the unit, engages with the gear on the water pump shaft. The unit

ELECTRICAL SYSTEM AND ACCESSORIES (GASOLINE ENGINE POWERED VEHICLES)

is a six-cylinder, semiautomatic, single breaker-arm type which contains the battery circuit contact points, automatic advance mechanism, and high-tension distributor.

b. Maintenance and Adjustments.

(1) **CAP.** The cap should be removed at regular intervals and examined. Check the high-tension wiring for frayed or damaged insulation and poor connections at the cap or plugs. Replace the cap or rotor if either is cracked or shows carbonized paths, indicating that there is current leakage to ground. Keep distributor housing and inside of distributor cap free from dust, oil or moisture.

(2) **BREAKER CONTACTS.** The breaker contacts should be inspected every 2,000 miles for condition and adjustment. If the contacts are dirty or gummy, they must be cleaned thoroughly; if rough or pitted, they should be replaced by installing a new breaker arm and points. Work on contacts should proceed as outlined below:

(a) Remove distributor cap shielding, cap and rotor (fig. 87).

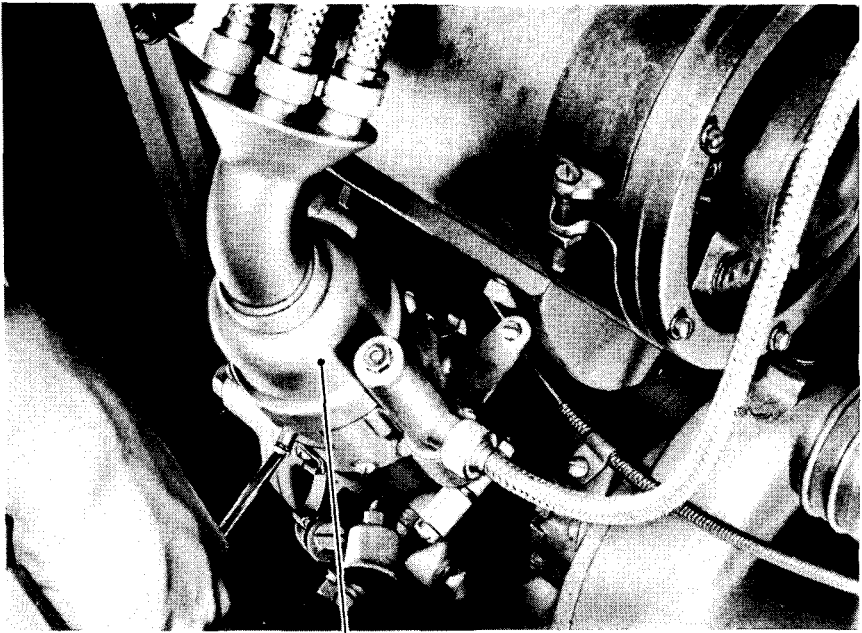

DISTRIBUTOR CAP SHIELDING

RA PD 13125

**Figure 87 — Distributor Shielding Upper Cover Removal -
(Gasoline Engine)**

SCOUT CAR M3A1

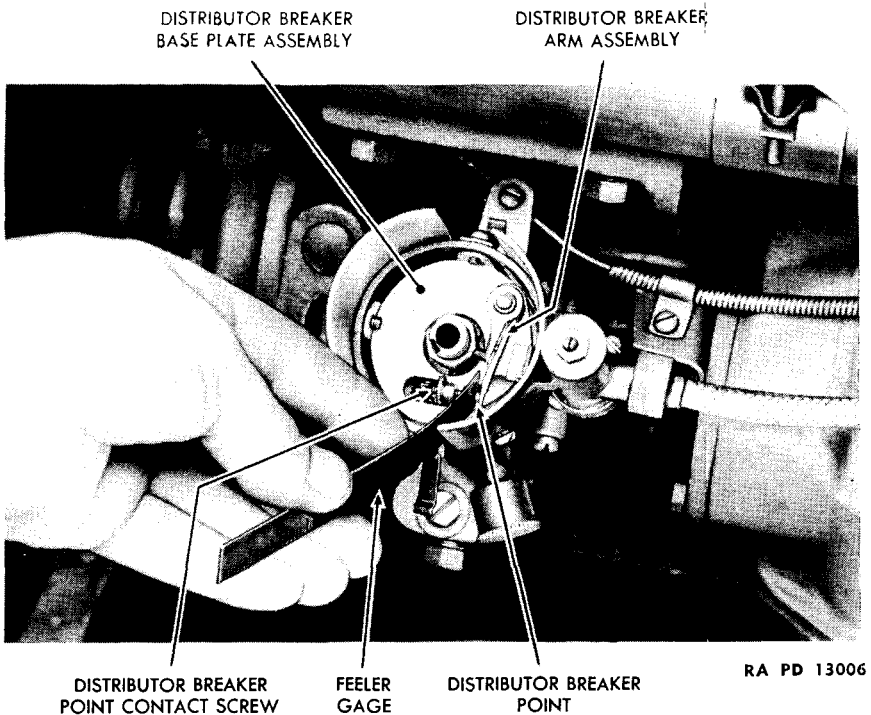

Figure 88 — Checking Distributor Points with Feeler Gage - (Gasoline Engine)

(b) Loosen the nut that holds the condenser wire and breaker arm spring to the breaker arm and remove the latter. Loosen the lock nut on the contact screw and remove it from breaker plate.

(c) Replace contacts and set breaker arm tension at 17 to 20 ounces as measured by a spring scale. This tension may be obtained by shifting the spring in the slot.

(d) Turn engine over until breaker contacts are fully separated.

(e) Loosen the lock nut on the contact screw, and with the use of a feeler gage, adjust to obtain maximum gap of 0.020 inch with points fully separated (figs. 88 and 89).

(f) Tighten nut on contact screw and recheck gap. Insert narrow strip of soft paper between the contacts and turn the engine until the contacts close. Draw the paper back and forth to remove any oil or grease remaining on the point surfaces and obtain good contact.

(g) Replace the rotor and check the cam setting by rocking back and forth as far as the slack in the distributor gears will permit. If the setting is correct, the points should open and close.

**ELECTRICAL SYSTEM AND ACCESSORIES
(GASOLINE ENGINE POWERED VEHICLES)**

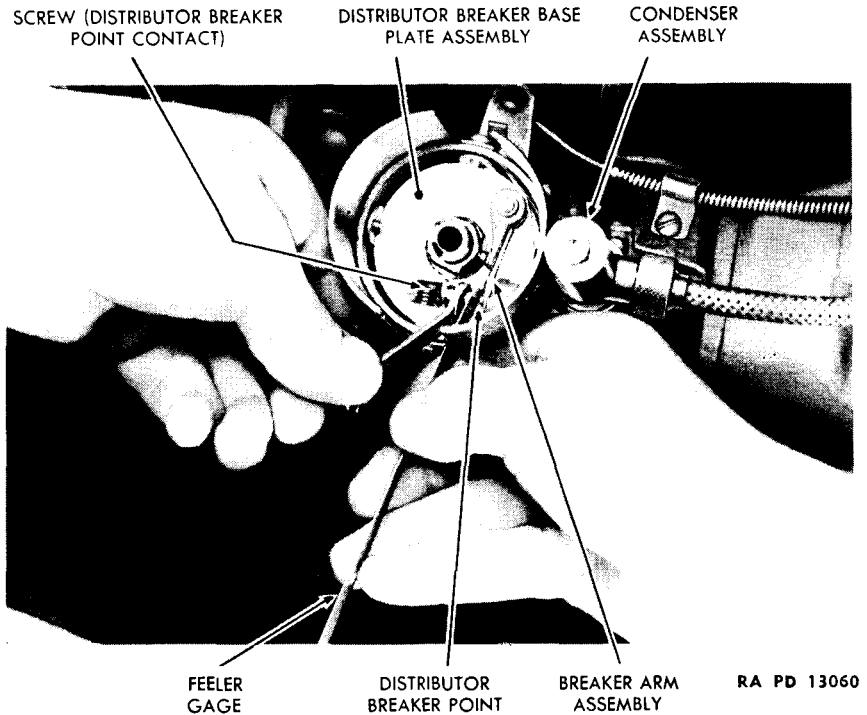

Figure 89 — Distributor Point Adjustment - (Gasoline Engine)

(h) Try out the engine at various speeds after replacing the distributor cap. If the engine does not run smoothly and develop its full power, check spark plugs and ignition wiring before retiming.

c. **Lubrication.** The early types of units were equipped with an oiling device. At the 1,000 mile inspection, add three or four drops of OIL, light engine, in the oiler on the outside of the housing. The later models are equipped with a grease cup on the outside of the base which should be turned down one turn every 1,000 miles. On all types, each 6,000 miles, lubricate the breaker arm with a wipe of light grease and add only one drop of OIL, light engine, on the breaker arm pivot pin, saturating the felt in the top of the breaker camshaft.

d. Removal.

Pliers, channellock

Screwdriver

Wrench, open-end, $\frac{3}{8}$ -in.

Wrench, open-end, $\frac{7}{16}$ -in.

(1) REMOVE DISTRIBUTOR CAP AND SHIELDS.

Screwdriver

SCOUT CAR M3A1

Loosen distributor cap shield locking screw. Release distributor cap holding clips, twist cap and shield counter clockwise and remove (fig. 87).

NOTE: High-tension wires should not be removed from the distributor cap unless close inspection shows defective cap; then install new cap by pulling out one high-tension wire at a time and pushing it in proper position on a new cap. Hold both caps in same position.

(2) DISCONNECT SPARK CONTROL.

Screwdriver

Loosen clamping screw holding control to arm assembly and pull out control.

(3) DISCONNECT PRIMARY WIRE.

Pliers, channellock

Wrench, open-end, $\frac{3}{8}$ -in.

Screwdriver

Remove distributor primary terminal shield by removing two machine screws. Unscrew conduit coupling nut from condenser shield. Remove primary wire from distributor terminal by unscrewing nut and lock washer and pull away primary wire and conduit assembly.

(4) REMOVE DISTRIBUTOR ASSEMBLY.

Wrench, open-end, $\frac{7}{16}$ -in.

Remove nut holding distributor arm to bracket on water pump and lift out assembly. Note exact position of rotor, so that distributor can be installed in correct timing position.

e. Installation.

Pliers, channellock

Wrench, open-end, $\frac{3}{8}$ -in.

Screwdriver

Wrench, open-end, $\frac{7}{16}$ -in.

(1) MOUNT DISTRIBUTOR ON WATER PUMP CASING.

Wrench, open-end, $\frac{7}{16}$ -in.

Place shaft into water pump casing, so that when gear on distributor meshes with gear on water pump the rotor is in exact position as when distributor was removed. If engine has been moved while distributor was out, it will be necessary to retime distributor as explained in paragraph 107. Place spring washer between two plain washers in position on control arm, and fasten distributor to bracket on water pump with special screw.

(2) CONNECT DASH CONTROL WIRE.

Screwdriver

Push wire through hole in machine screw in end of control arm and secure with the screw.

**ELECTRICAL SYSTEM AND ACCESSORIES
(GASOLINE ENGINE POWERED VEHICLES)**

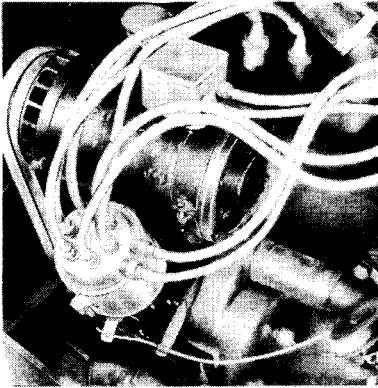

A — INSTALLED VIEW

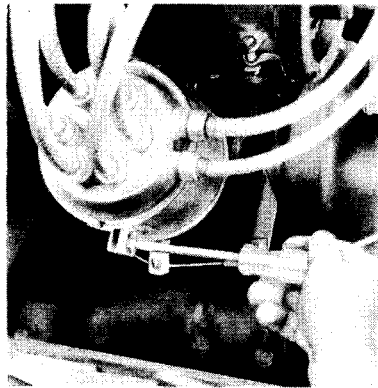

B — CLAMPING SCREW REMOVAL

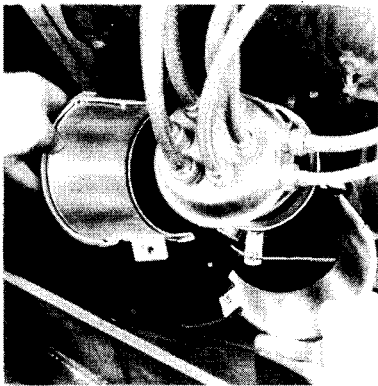

C — DISTRIBUTOR SHIELD REMOVAL

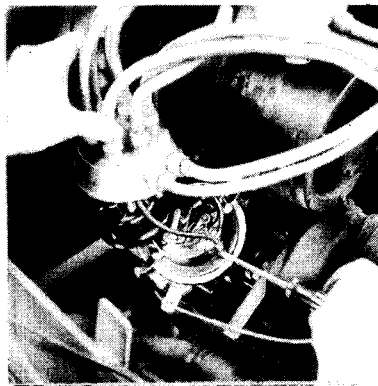

D — PRIMARY LEAD REMOVAL

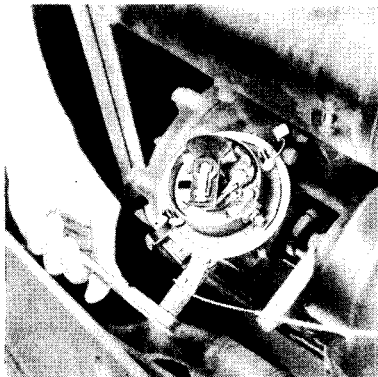

E — HOLD DOWN CLAMP SCREW REMOVAL

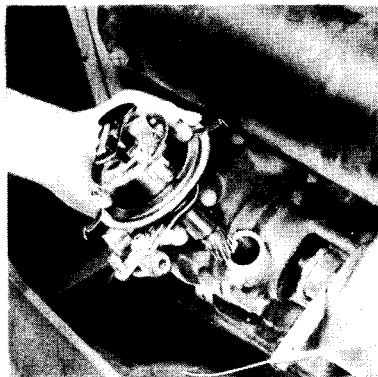

F — DISTRIBUTOR REMOVAL

RA PD 42217

**Figure 90 — Steps Showing Removal of Distributor Assembly -
(Gasoline Engine)**

SCOUT CAR M3A1**(3) CONNECT PRIMARY WIRE.**

Pliers, channellock
Screwdriver

Wrench, open-end, $\frac{3}{8}$ -in.

Remove condenser shield and place low-tension wire over condenser lead terminal on terminal post. Secure with hexagon nut and lock washer. Fasten conduit coupling nut to shield. Replace condenser shield and secure with two screws and lock washers.

(4) INSTALL CAP AND UPPER SHIELD.

Screwdriver

With high-tension wires in proper position, place cap over distributor and secure with clips. Twist upper distributor shield clockwise to clamp it and tighten locking screws.

f. Removal (for Latest Models) (fig. 90, step A). NOTE: Under certain conditions, it is impossible to replace a distributor without timing the engine. Where the engine has been turned over, the following procedure cannot be followed and the engine must be retimed. Refer to this section, paragraph 107.

Screwdriver

Wrench, socket, $\frac{9}{16}$ -in.

(1) REMOVE DISTRIBUTOR SHIELD ASSEMBLY (fig. 90, steps B and C).

Screwdriver

Screw out distributor shield assembly clamping screw. Remove both halves of the shield assembly.

(2) REMOVE DISTRIBUTOR CAP (fig. 90, step D).

Screwdriver

Upon removal of distributor cap, note the firing position of rotor. Un-screw primary lead and remove distributor cap. CAUTION: Engine must not be turned over.

(3) REMOVE DISTRIBUTOR ASSEMBLY (fig. 90, steps E and F).

Screwdriver

Wrench, socket, $\frac{9}{16}$ -in.

Disconnect manual control cable. Remove the clamp hold down screw. Lift out distributor.

g. Installation (for Latest Models).

Screwdriver

Wrench, socket, $\frac{9}{16}$ -in.

(1) INSTALL DISTRIBUTOR ASSEMBLY (fig. 90, steps E and F).

Screwdriver

Wrench, socket, $\frac{9}{16}$ -in.

Place the distributor assembly in the opening provided in the water pump housing in such a way as to bring the grease cup on the distributor at a right angle to and toward the outside of the engine block. Make

**ELECTRICAL SYSTEM AND ACCESSORIES
(GASOLINE ENGINE POWERED VEHICLES)**

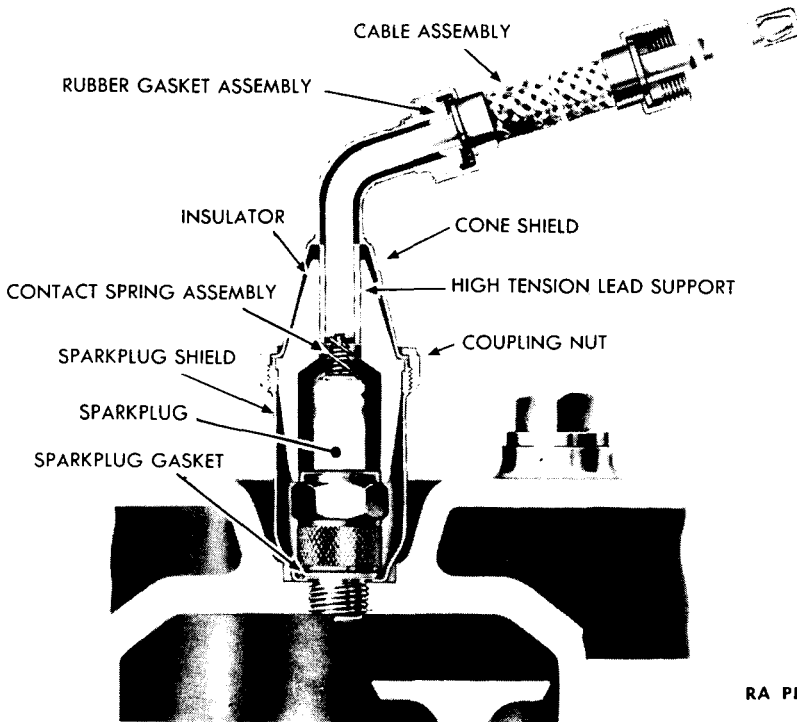

RA PD 43421

Figure 91 — Spark Plug with Shielding - Installed - (Gasoline Engine)

certain that the gear at the bottom of the distributor shaft meshes properly with the gear on the pump shaft. Tighten the hold down clamp screw. Connect manual control cable.

(2) INSTALL DISTRIBUTOR CAP (fig. 90, step D).

Screwdriver

Replace spark plug cables in their proper firing order in distributor cap. Connect and tighten primary lead. (It is most important that the rotor be in the same firing position as on removal.)

(3) INSTALL DISTRIBUTOR SHIELD ASSEMBLY (fig. 90, steps B and C).

Screwdriver

Place both halves of shield around cap and tighten clamping screw. Make necessary spark adjustment, as required.

105. SPARK PLUGS (fig. 91).

a. Description. The spark plugs are of conventional construction with a gap that can be set by bending the side electrode. When the

SCOUT CAR M3A1

1 - BROKEN INSULATOR TOP
(CARELESS HANDLING)



2 - SPLIT INSULATOR
(BENDING CENTER
ELECTRODE)

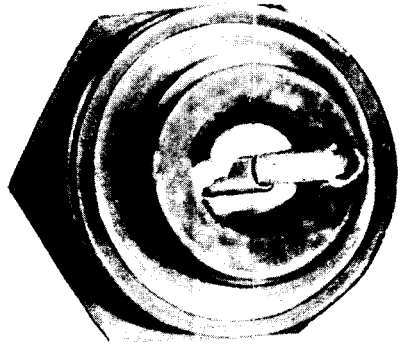

3 - SIDE ELECTRODE WORN
(LOOSE PLUG OR TOO HOT)

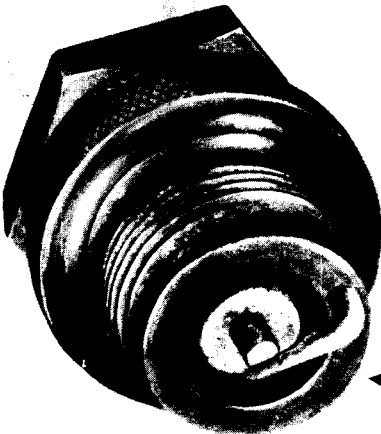
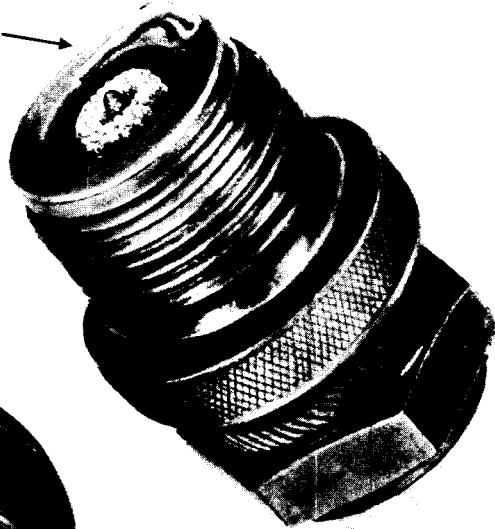

4 - PLUG BADLY BURNED
(PRE-IGNITION OR INADEQUATE
COOLING)

RA PD 3572B

Figure 92 — Spark Plug Applications and Operating Conditions

**ELECTRICAL SYSTEM AND ACCESSORIES
(GASOLINE ENGINE POWERED VEHICLES)**

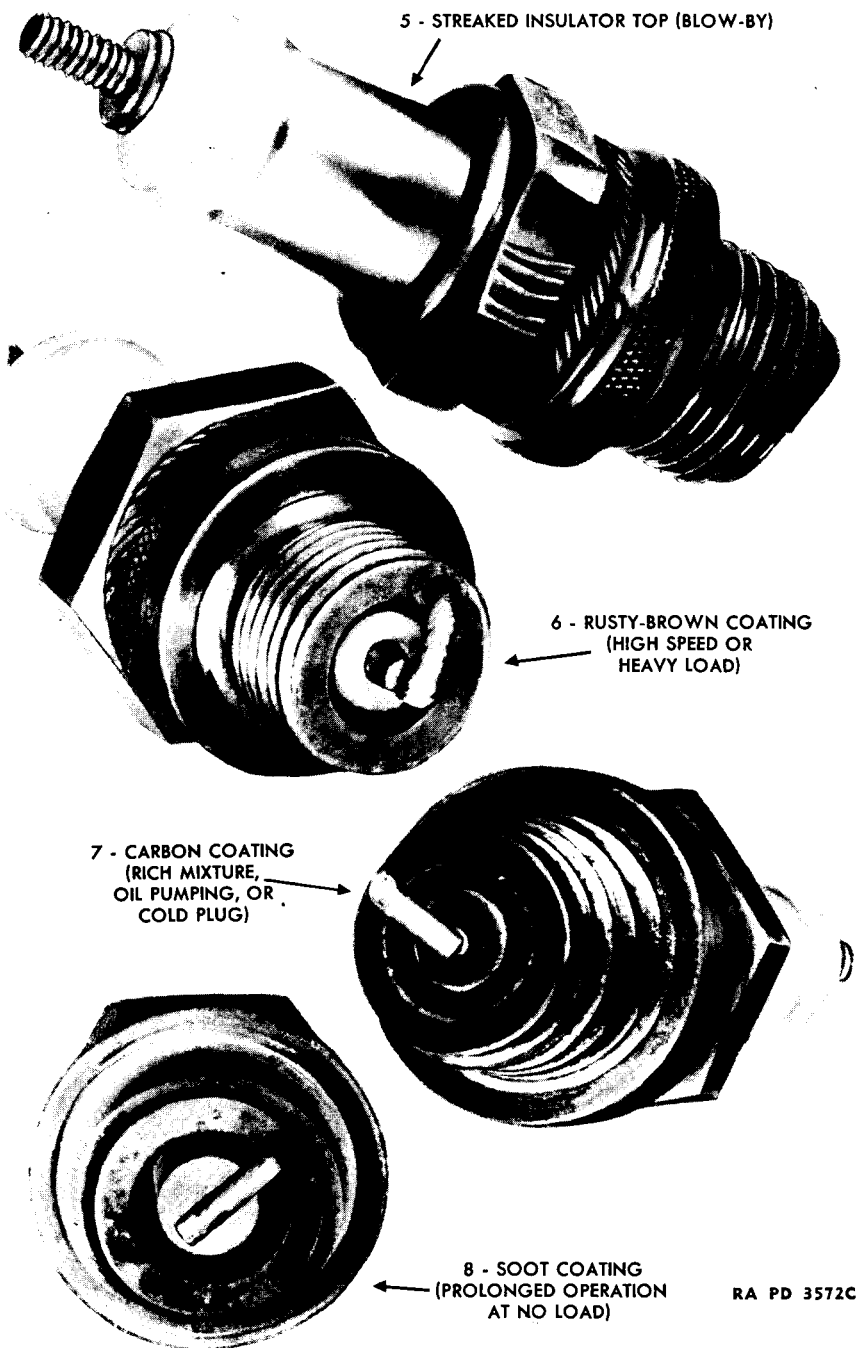

RA PD 3572C

Figure 93 — Spark Plug Applications and Operating Conditions

SCOUT CAR M3A1

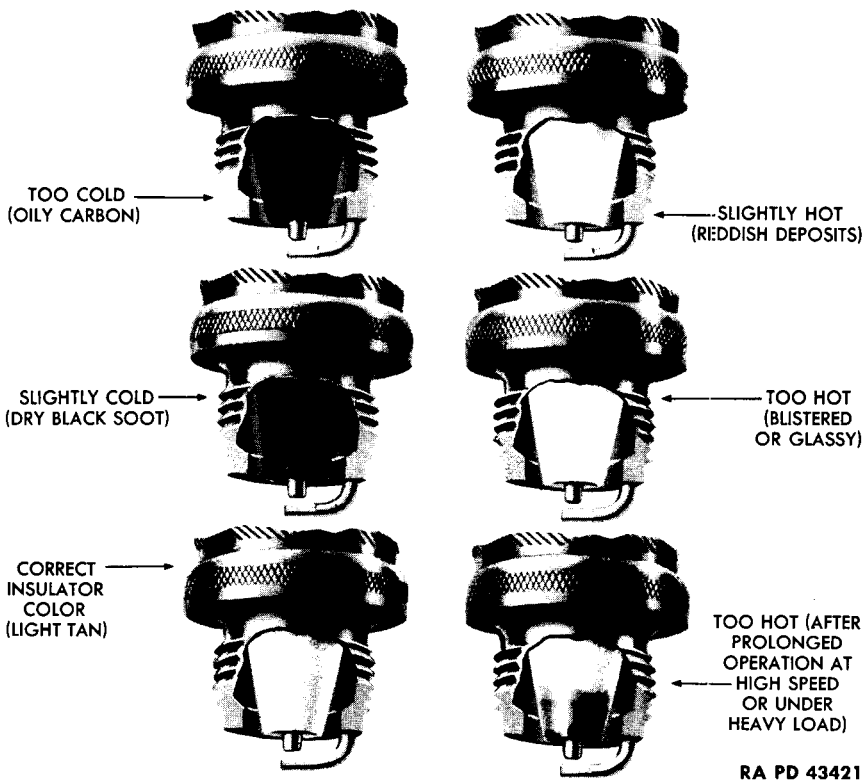

Figure 94 — Spark Plug Applications and Temperature Effects

circuit is closed from the ignition coil to the plug, a spark jumps at the gap and ignites the gas in the combustion chamber. Spark plug size is 14 mm. The spark at the points of each spark plug must be of full strength at all engine speeds and under all conditions of operation.

b. Servicing. Gaps should be checked carefully with a feeler gage every 500 miles. Plugs should be checked in a tester every 4,000 miles, cleaned if necessary, and regapped to 0.025 inch.

c. Replacement (figs. 92, 93 and 94). Gaps are burned open by the constant application of heat, spark, pressure, and the chemical action of the fuel mixture. Electrodes become oxidized and corroded, causing increased resistance to the passage of current. The firing end of the core becomes crusted with carbon and other deposits, resulting in missing because of current loss over and through these deposits. Plugs may develop a gas leakage between the core and shell, or between the center

ELECTRICAL SYSTEM AND ACCESSORIES (GASOLINE ENGINE POWERED VEHICLES)

electrode and core. Experience indicates that by reason of all of the above, spark plugs literally wear out and should be replaced after 10,000 miles.

d. Removal of Spark Plug.

Wrench, socket, with ratchet extension, $\frac{1}{8}$ -in.

(1) REMOVE SHIELDING. Unscrew shield coupling nut by hand. Push aside upper shield and remove insulator.

(2) REMOVE SPARK PLUG.

Wrench, socket, with ratchet extension, $\frac{1}{8}$ -in.

Place wrench on spark plug and screw it out of cylinder head. Remove lower shield and copper gasket.

e. Installation of Spark Plug.

Wrench, socket, with ratchet extension, $\frac{1}{8}$ -in.

(1) INSTALL SPARK PLUG.

Wrench, socket, with ratchet extension, $\frac{1}{8}$ -in.

Place a new copper gasket on the seat in the cylinder head. Set plug in its lower shield and screw it into head. Avoid using excessive pressure when tightening plugs.

(2) INSTALL SHIELDING. Place insulators in upper spark plug shields so that wire terminals enter insulators. Insert lower ends of insulators into lower shields so that wire terminals engage upper ends of plug electrodes. Screw shield coupling nuts onto lower spark plug shields.

106. SHIELDING (fig. 95).

a. **Description.** In order that sensitive radio equipment may be operated without interference, the ignition and wiring systems of the vehicle are completely shielded and the shielding is grounded. Standard unshielded ignition or automotive cable with eyelet terminals and rubber sleeves is within the flexible metallic conduit. Knurled coupling nuts may be turned by hand.

b. **Precautions.** The type of shielding employed in these vehicles does not require frequent adjustment or excessive care but does require frequent inspection to insure that it is tight and clean. In order to be effective, the shielding system must be electrically continuous throughout, with no breaks or high-resistance joints, and it is for this reason that all joints must be kept very tight and free from oil, grease, or insulating substances. If crushed, the inside weatherproofing conduit spreads, thus opening the shielding to water and leaks. Oil, water, and fuel may also enter the conduit if coupling nuts are allowed to work loose.

SCOUT CAR M3A1

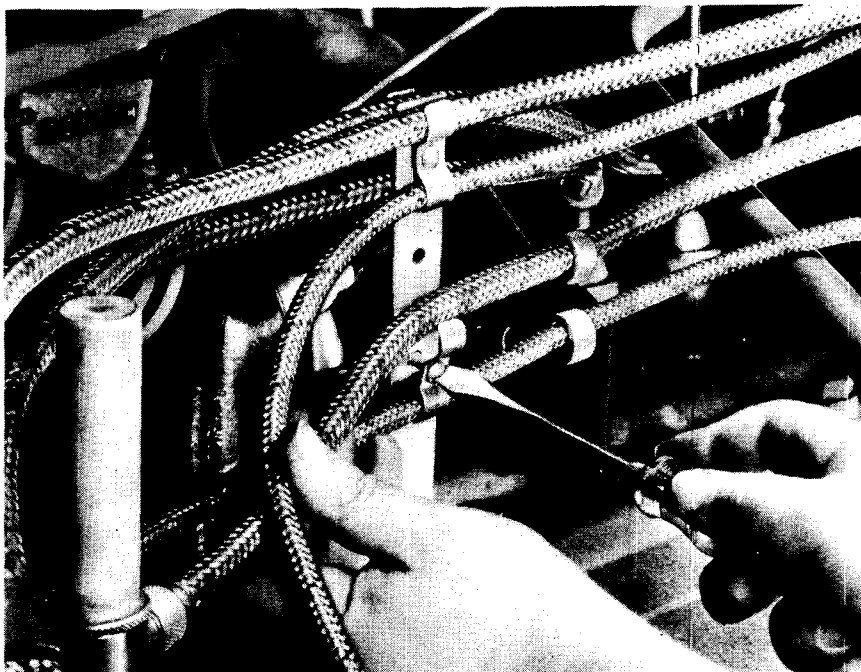

RA PD 13136

Figure 95 — Radio Shielding Removal

If abrasion takes place in the metal braid applied over the conduit, so that gaps appear, the shielding will no longer be effective.

c. Maintenance. Servicing of the vehicle should include inspection of the shielding for crushed conduit, abrasion of shielding, and looseness of coupling nuts. In cleaning couplings or plug shields, a solution of CARBON TETRACHLORIDE should be used. In the event that oil or fuel has seeped into the conduit, the latter and its wiring should be disconnected, removed, cleaned and replaced. In removing the length of wire from a shield, a piece of strong twine should be attached to the end of the wire and pulled through as the wire is removed; the "fish" line can then be used to pull through cleaning rags and facilitate replacement of wire later. Coupling threads should be cleaned to brightness with a small wire brush to remove high-resistance oxidation.

d. Testing. An insulation or resistance testing instrument (Megger) will be of invaluable service, if available, in testing shielding and conduit insulation and resistance very rapidly, and tracing circuit continuity.

**ELECTRICAL SYSTEM AND ACCESSORIES
(GASOLINE ENGINE POWERED VEHICLES)**

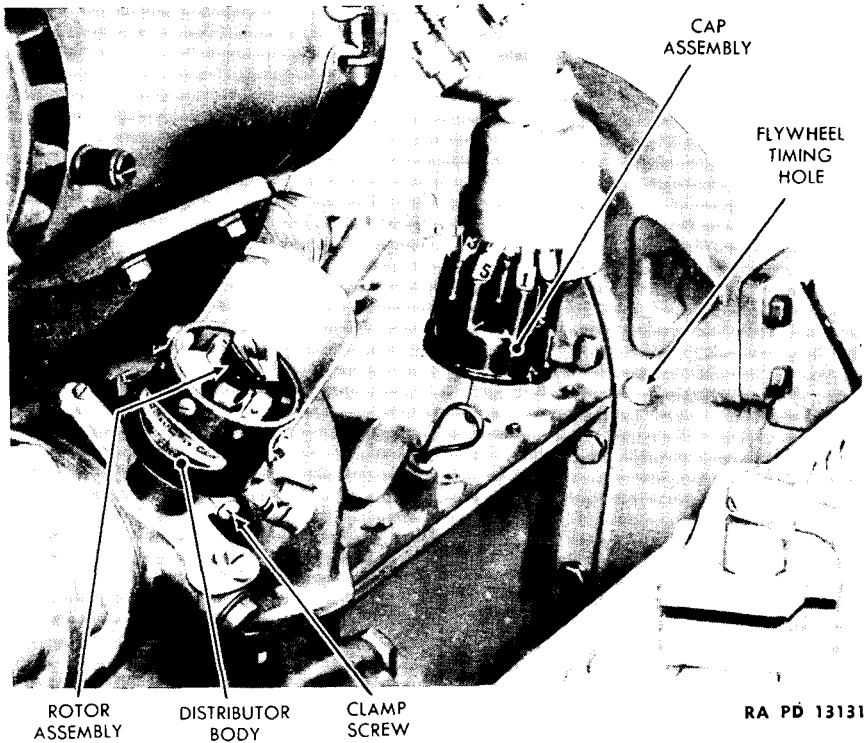

Figure 96 — Timing the Engine - (Gasoline Engine)

107. TIMING.

a. The correct ignition timing is of the utmost importance for the proper operation of the engine. In consequence, the ignition unit should not be disturbed until it is positively known to be inoperative or out of adjustment.

b. **Adjustment.** The timing should be checked and adjusted as follows:

(1) First remove the cap assembly (fig. 96). Check the breaker points carefully to make sure that they are in good condition and have the correct gap of 0.020 inch maximum, when fully separated (par. 104 b (2)).

(2) Turn the engine over by hand in the direction of normal running (counterclockwise looking at fan from driver's seat) until the No. 1 piston reaches top dead center on the compression stroke, as indicated by the centering of the flywheel DC mark in the flywheel timing hole (fig. 96).

(3) Pull the spark control button out to the full limit for the manually retarded position.

SCOUT CAR M3A1

(4) With the spark plug wires, trace the lead from No. 1 plug; the rotor contact should have a position opposite the No. 1 terminal in the cap. If this is not the case, loosen the advance arm clamp screw (fig. 96) and rotate the distributor body around the shaft until the No. 1 terminal is opposite the rotor assembly contact (fig. 96), with the points just beginning to open. The opening can be checked by a feeler of a very thin strong paper, or by the ammeter when the ignition switch is turned on. Be sure to tighten the advance arm clamp screw after making the adjustment. On this position, therefore, the No. 1 cylinder will fire at idling speed with fully retarded spark at top dead center. The firing order is 1-5-3-6-2-4.

108. IGNITION TROUBLE SHOOTING.

A systematic analysis of fundamentals is of great value in locating trouble. An accurate low scale direct-current ammeter will aid in localizing difficulties. The following is a suggested routine for trouble shooting:

a. Coil Distributor Circuit. Remove the coil distributor high-tension (secondary) cable, and hold it $\frac{3}{8}$ inch from ground (any convenient metal part of the engine, free of gasoline, oil, etc.). Make and break the primary circuit with the ignition turned on, either by using the starting motor or by moving the cam inside the distributor back and forth. A hot, snappy spark should result and, if so, proceed to test as given in **b** in this paragraph. If no spark occurs, check the coil distributor wire to make sure it can conduct current, or substitute a wire known to be good, and repeat. If a weak spark is obtained, either the condenser or coil, or both, are at fault. Turn the engine over with the starting motor, and look for excessive arcing at the breaker points, which would indicate a bad condenser. Replace condenser and repeat original test. If spark is still weak, coil replacement is indicated.

b. Distributor Cover. With the coil distributor wire inserted in the center well of the distributor cover, remove cover, and turn engine over to produce current in the secondary circuit. Observe cover interior for cracks and moisture, and watch for leakage or a short circuit wherein sparks jump from the center terminal to the spark plug terminals. Carbon paths, which resemble cracks, will also be apparent in the bakelite of the cover. To test whether the secondary circuit is established through the center brush or terminal inside the distributor cover, hold one end of a high-tension cable against this point, with its other end $\frac{3}{8}$ inch from the ground. A spark should jump to ground when secondary current is induced.

c. Distributor Rotor. A grounded rotor will interrupt the passage of current between the center segment and the spark plug cables. To test

ELECTRICAL SYSTEM AND ACCESSORIES (GASOLINE ENGINE POWERED VEHICLES)

the insulation of the rotor, detach the cable leading from the coil (detach at cover). Then, remove the distributor cover, and hold the coil distributor cable approximately $\frac{3}{8}$ inch from the rotor. Induce a secondary voltage by making and breaking the primary circuit, and if a spark occurs, the rotor is grounded and must be cleaned or replaced.

d. Spark Plug Cables. Having proved that the secondary current reaches the spark plug cables, check the cables by removing each one in turn from its plug, holding it approximately $\frac{3}{8}$ inch from the ground, and inducing a secondary voltage by turning over the engine with the starting motor. If a spark does not occur with regularity in any cable, the cable must be replaced.

e. Spark Plug Testing. With the secondary current checked as far as the plugs, the latter must be tested to make sure that the spark jumps its gap and ignites the charge in the cylinder. There are several ways in which faulty plugs may be detected.

(1) A commercial spark plug tester may be used. This instrument requires the plug to fire in a chamber of compressed air whose pressure may be regulated. A mirror arrangement permits observation of sparks, occurring at the electrodes, and external sparking or leaking may be noted for faulty plugs.

(2) A spark that will jump the point or gap of a spark plug, when the plug is out of the cylinder, may not have enough strength to jump when the plug is screwed in the cylinder and under compression.

(3) If a plug does not fire satisfactorily after it has been cleaned and adjusted for the correct gap setting, replace it.

f. Ammeter Indicates Constant Normal Discharge. Under such circumstances, the primary circuit is complete, but it is not being interrupted to induce a secondary discharge. Several tests can be made for checking troubles of this kind in circuits beyond the ignition coil.

(1) **DISTRIBUTOR.** Disconnect the primary wire where it enters the distributor; and if the ammeter needle returns to zero, the distributor or condenser is at fault. Remove the distributor cover and watch for opening of contact points; look for presence of foreign matter as a shunt around the points; inspect terminal insulation to insure that the movable point is not grounded; check condenser. If the condenser is shorted, a spark will occur when the condenser "pigtail" is disconnected from the distributor and touched to the live wire.

(2) **COIL DISTRIBUTOR WIRE.** If the ammeter needle does not return to zero when the primary circuit is opened at the distributor as above, reconnect the wire to the distributor and disconnect the end at the pri-

SCOUT CAR M3A1

mary exit of the coil to check for a grounded coil distributor wire. If the needle still does not return to zero, examine the coil terminal for a ground, foreign material, etc. If no ground is found externally, the trouble must be inside the coil where one of the primary windings near the exit may be grounded. Coil replacement is necessary.

g. Ammeter Shows No Discharge. A zero reading on the ammeter, with the ignition switch closed, indicates an open circuit. Ground the terminal where the primary winding enters the distributor, and if a spark results, the trouble is in the distributor. If no spark occurs, the fault lies back toward the coil.

(1) **DISTRIBUTOR.** Check the points for closing and make sure that there is a continuous path for the current through the points to ground (distributor base).

(2) **PRIMARY CIRCUIT.** Test for current on the *battery side* of the ammeter (hold one end of test wire at the terminal being checked and strike the other end on a convenient ground). If the starting motor turned the engine, current must be available, and by starting at the ammeter, the trouble may be traced from there.

(a) If a spark is obtained on the battery side of the ammeter, *place this lead on the opposite terminal of the ammeter to shunt the ammeter during remainder of the test* and protect against excessive test currents.

(b) Continue the tests for the fuse, the battery (hot) side of the ignition switch, the dead side with the switch closed, and so on to complete the circuit to the distributor. The break or defect will be found between the last terminal that showed the presence of current and the next succeeding one that denoted its absence. After satisfactory repair or replacement has been accomplished, the ammeter should be reconnected in the circuit.

h. Ammeter Shows Abnormal Discharge. Such a discharge may be caused by a ground before the primary current passes through the majority of the primary windings of the coil. The trouble can be localized by observing the ammeter while turning the ignition switch.

(1) **SWITCH "OFF."** If the dash ammeter registers zero with the switch "off," trouble must be past the switch but short of the coil exit terminal.

(2) **SWITCH "ON," OR "OFF."** If the discharge exists with the switch either "on" or "off," the trouble lies between the ammeter and switch, involving an examination of the generator circuit and lead to the fuse box. Remove the respective wires to note effect on ammeter and localize fault. A large discharge or *direct* short should burn out a fuse.

109. FUSES.

Conventional automotive-type, glass-tube-inclosed fuses are mounted

ELECTRICAL SYSTEM AND ACCESSORIES (GASOLINE ENGINE POWERED VEHICLES)

on a fuse and junction block which is secured behind the instrument panel within the instrument shielding box. Access to the fuses is obtained by loosening the wing nuts below the box and removing the cover plate. A set of spare fuses should always be available.

110. SWITCHES.

a. **Starter.** Foot-operated. To remove, disconnect leads and remove screws from toeboard.

b. **Ignition.** Key type.

c. **Stop Light.** Pressure type. To remove, disconnect leads and unscrew from master cylinder fitting.

d. **Head Lamp Beam.** Foot-operated, push-button type. To remove, disconnect leads and remove two screws from toeboard.

e. **Panel Lights.** Controlled from lighting switch.

f. **Heater.** Rheostat type. To remove, disconnect leads; pull off knob, loosen and remove lock nut at front of panel with a $\frac{3}{4}$ -inch wrench; pull out rheostat to the rear.

g. **Voltmeter.** Toggle type. To remove, disconnect leads; loosen lock nut at rear of panel with $\frac{5}{8}$ -inch open-end wrench; unscrew and remove knurled lock nut at front of panel by hand; pull out switch at rear.

h. **Fuel Gage.** Double-throw toggle type. To remove, disconnect leads; loosen and remove two screws, nuts and lock washers with a screwdriver and $\frac{13}{32}$ -inch wrench.

i. **Horn Button.** Refer to section XXXII, paragraph 217 a and b for removal and installation procedure.

j. **Light.** Pull-out type with positions, "Off," "Blackout" and "Service." To remove, disconnect leads; loosen small screw in switch knob boss by inserting a small screwdriver; unscrew knob by hand; loosen and back off switch-mounting nut behind panel, using a $\frac{3}{4}$ -inch open-end wrench; push down on lock-out button and slide off knob. Remove switch to the rear.

111. TERMINAL BOX.

A radio terminal box, with several terminals for extending the battery connections to a convenient point for the radio hook-up, is mounted on the bulkhead, facing the crew compartment.

112. HEAD LAMPS.

a. **Description.** Two types of head lamps are mounted on each vehicle: the service head lamp, used during normal operating conditions, and the blackout head lamp.

SCOUT CAR M3A1

(1) **THE SERVICE HEAD LAMP.** Two single bulb head lamp assemblies are employed. A high or low beam can be obtained from the Mazda lamps No. 1122 (32/21 c.p., 12-16 V., double-contact, Candelabra-bayonet type). Lens are removable to facilitate removing the lamp and cleaning the reflectors by loosening the screw at bottom of molding and removing molding with the lens. The head lamps are the prefocused type, so the only adjustment is the position in which the light is mounted. This can be adjusted by loosening the mounting nut under the fender, and properly positioning the lamp.

(2) **THE BLACKOUT LAMP.** Two small separate front marker lamps equipped with standard blackout devices are provided, comprising Mazda lamps No. 67 (3 c.p., 12-16 V., single-contact, Candelabra-bayonet type). The marker lamp can be changed by removing screw at bottom of molding and removing molding with lens.

(3) Late production vehicles are being equipped with a new type blackout reflector lamp which is constructed to give the appearance of one point of light at distances of 60 feet in advance of the vehicle, and of two points of light at distances less than 60 feet, indicating caution to the approaching driver.

b. Maintenance and Adjustments. Great care should be exercised in dismantling and replacing lens and lamps because of their fragility. Prying or grasping with tools, unless protected by some soft buffer material, should be avoided. Lighting circuits should not be energized while such equipment is being replaced, to protect against short circuits and unnecessary blowing of fuses. In cases where lamps must be operated without lenses, cover the fixture body to protect interior reflectors and sockets against the atmosphere. Head lamps are protected by metal guards. The head lamp wiring is disconnected at the base by pulling out a plug.

113. TAIL LAMPS.

The units are of two types:

a. Left. Combination blackout tail lamp (upper element), service tail and stop light (lower element) unit is provided at the left rear of the vehicle. It includes a Mazda lamp No. 67 (3 c.p., 12-16 V., double-contact, Candelabra-bayonet type) and a Mazda lamp No. 1176 (21/6 c.p., 12-16 V., double-contact, Candelabra-bayonet type).

b. Right. Combination blackout tail lamp (upper element) and blackout stop light (lower element) unit is provided at the right rear of the vehicle. It includes Mazda lamps No. 67 (3 c.p., 12-16 V., single-contact, Candelabra-bayonet type).

c. Current-production vehicles are equipped with improved rear

**ELECTRICAL SYSTEM AND ACCESSORIES
(GASOLINE ENGINE POWERED VEHICLES)**

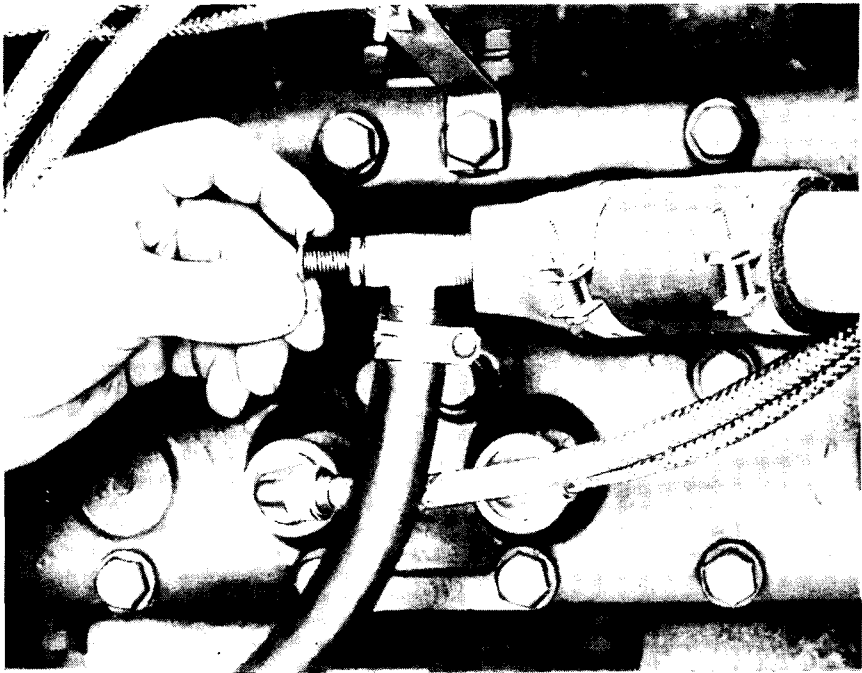

RA PD 13057

Figure 97 — Heater Hose Shut-off Cock - (Gasoline Engine)

lamps as follows: Combination service tail and stop light (upper unit) and blackout taillight (lower unit) is provided at the left rear of the vehicle; combination blackout stop light (upper unit) and blackout taillight (lower unit) is provided at the right rear of the vehicle. The upper and lower units are separately sealed replaceable units. The rear blackout lamp is so constructed that when viewed from distances of 180 feet or more, a single beam of light is seen. When viewed from between 60 and 180 feet, two beams of light are seen, and at distances less than 60 feet, four beams of light can be seen. This feature enables drivers to follow vehicles at safe distances.

114. HEATER.

A conventional hot water heater is provided. Water circulation may be shut off from the engine by a shut-off cock where the inlet hose connects to the engine (fig. 97), but there is no valve or shut-off cock at the outlet. Repair or replacement of the heater or its hose usually will require drainage of cooling system.

SCOUT CAR M3A1

a. Removal.

(1) DETACH HOSE CONNECTIONS.

Screwdriver

Close shut-off valve at top of engine. Loosen two hose clamps at heater tubes and disconnect hose. Loosen two similar clamps at engine to remove hose for replacement purposes.

(2) DISCONNECT MOTOR LEAD. Remove cable from connector.

(3) REMOVE HEATER FROM DASH.

Wrench, open-end, $\frac{9}{16}$ -in.

Remove three nuts, three lock washers and three plain washers mounting heater to dash and remove heater.

b. Installation.

(1) MOUNT HEATER ON INSIDE OF DASH.

Wrench, open-end, $\frac{9}{16}$ -in.

Pass tubes of core outward through holes in dash. See that spacers are on three attaching studs of housing; slip studs through holes in dash. Attach plain and lock washers and nuts at front of dash and tighten nuts.

(2) CONNECT HEATER TO ENGINE.

Screwdriver

Slip hose ends on tubes in front of dash and replace hose clamps. Mount hose in supporting clips and tighten nuts on screws.

115. HORN.

A dual-type (high and low note) vibrator horn is provided and mounted on the engine side of the dash at the right. A horn relay is also required and installed therewith.

Section XX

**ELECTRICAL SYSTEM AND ACCESSORIES
(DIESEL ENGINE POWERED VEHICLES)**

	Paragraph
General description	116
Batteries	117
Starting motor	118
Generator	119
Voltage regulator and filter.....	120
Series-Parallel switch	121
Shielding	122
Fuses	123
Electrical system trouble shooting.....	124
Switches	125
Terminal box	126
Head lamps	127
Tail lamps	128
Heater	129
Horn	130

116. GENERAL DESCRIPTION.

The electrical system of the Diesel-powered vehicle is different from that of gasoline-powered unit in that a 12-24 volt system is employed. The extra horsepower required to crank the Diesel engine necessitates a cranking unit of heavy construction, both mechanically and electrically. To comply with this, special switches and controls are used. Due to the torque and speed required to start a Diesel, a 24-volt starter unit is used. A series-parallel switch connects the two 12-volt batteries in series for starting the engine and when the starter button is released, the switch connects the batteries in parallel. The batteries, in series, give the 24 volts necessary for starting, and in parallel, the 12 volts normal vehicle voltage. The starter motor is energized through a solenoid starting switch. The electrical wiring diagram of the system is shown in figure 98. The system includes the two batteries, starting motor, generator, voltage regulator, filter, series-parallel switch, solenoid switch and the miscellaneous lighting, protective and control equipment.

117. BATTERIES.

The two 6-cell, 12-volt batteries are located in separate compartments, one on each side of the frame, directly behind the front fenders. Radio connection terminals are provided. Each cell of the battery contains 25 plates.

SCOUT CAR M3A1

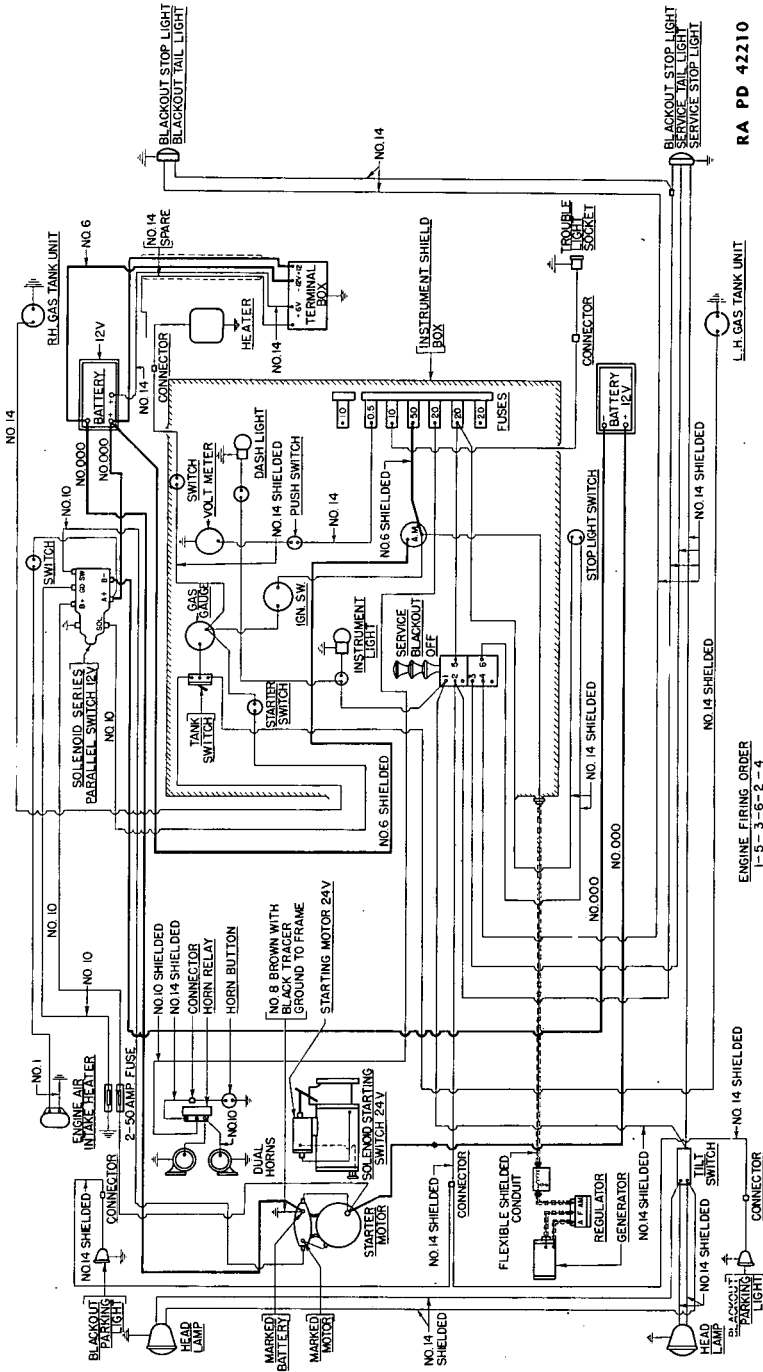

RA PD 42210

ENGINE FIRING ORDER
1-5-3-6-2-4

Figure 98 — Wiring Diagram - Diesel Engine Vehicles

ELECTRICAL SYSTEM AND ACCESSORIES (DIESEL ENGINE POWERED VEHICLES)

- a. **Voltmeter Check.** The direct-current voltmeter may be used to indicate, to some degree, the condition of each battery insofar as its capacity to supply current is concerned. With the engine shut down and no load on the battery, the open circuit reading should be approximately 12 volts.
- b. **Battery Fluid.** Refer to section XIX, paragraph 99 b of this manual for information relative to inspection and care of battery fluid.
- c. **Maintenance.** See section XIX, paragraph 99 c.
- d. **Temperature Effects and Storage.** See section XIX, paragraph 99 d.
- e. **Removing Battery from Compartment.** See section XIX, paragraph 99 e for removal of right-hand battery. The left-hand battery is removed in the same way.
- f. **Replacing Battery in Compartment.** See section XIX, paragraph 99 f for installing right-hand battery in compartment. The left-hand battery is installed in the same way.

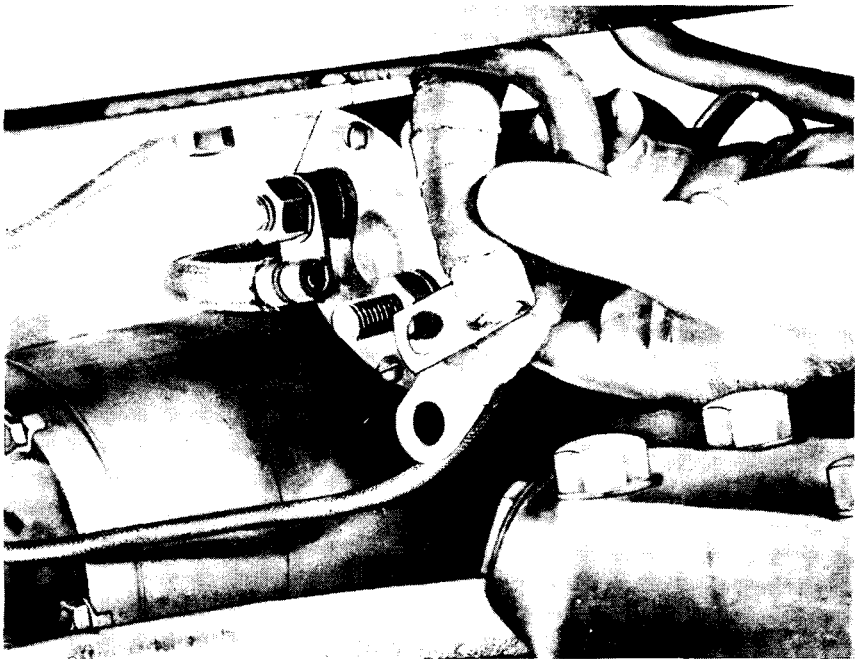

RA PD 13138

**Figure 99 — Disconnecting Cables from Starting Motor -
(Hercules Diesel)**

SCOUT CAR M3A1

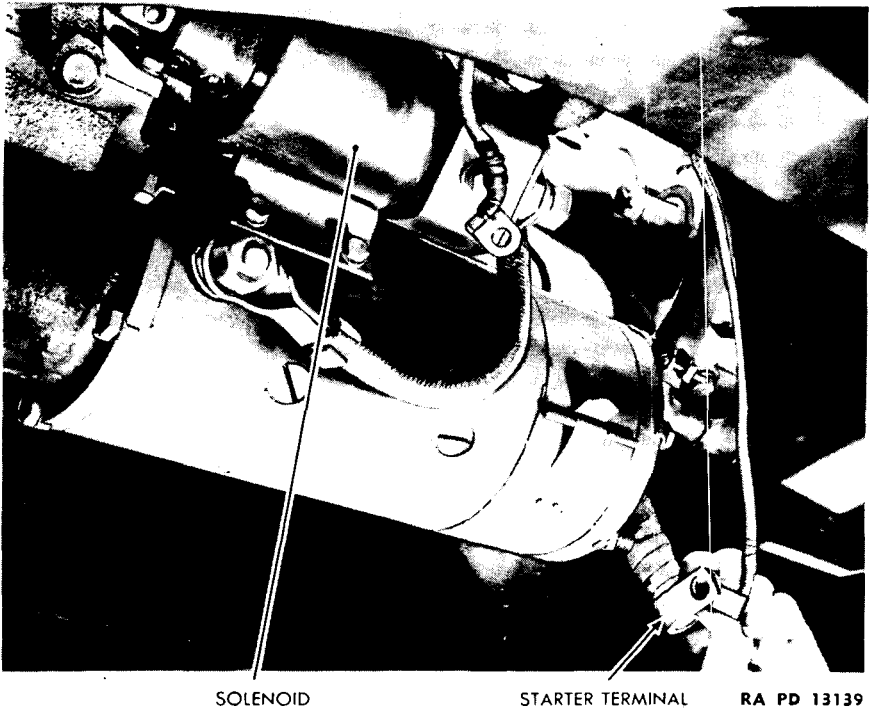

**Figure 100 — Disconnecting Starting Motor Terminals -
(Hercules Diesel)**

118. STARTING MOTOR.

a. Description. The starting motor is a 6-pole, 12-brush, 24-volt unit which is mounted to the flywheel housing. It has the Dyer-type drive which engages the pinion with the flywheel ring gear. The Dyer drive provides for positive engagement of the starting motor pinion with the flywheel before the starting motor switch contacts are closed, or the armature is rotated. This eliminates clashing and the possibilities of broken or burred teeth on either the pinion or flywheel. **CAUTION:** Cranking of the motor should never be attempted for more than 30 seconds continuously without stopping and waiting 2 minutes or longer for the starting motor to cool. If the engine does not start after one or two attempts, do not continue to crank, as this is injurious to the starting motor. Investigate and determine the condition that is preventing the engine from starting.

b. Maintenance and Adjustments. See section XIX, paragraph 100 b.

c. Trouble Shooting. If the cranking motor does not develop rated torque, and cranks the engine slowly or not at all, check the batteries,

**ELECTRICAL SYSTEM AND ACCESSORIES
(DIESEL ENGINE POWERED VEHICLES)**

battery terminals and connections, ground cables and battery to cranking motor cables. Check the series-parallel switch and the solenoid switch connections. The starter switch should be checked for burned contacts. Check the brushes and commutator. Clean the commutators with PAPER, sand, No. 00 (never use emery cloth). If such an inspection fails to locate the trouble, replace the starting motor.

d. To Remove Starting Motor.

Wrench, open-end, $\frac{7}{8}$ -in.

Wrench, open-end, $\frac{7}{8}$ -in.

Wrench, open-end, $\frac{3}{4}$ -in.

Disconnect the two large terminals, using a $\frac{3}{4}$ -inch open-end wrench; and disconnect the small terminal, using a $\frac{7}{8}$ -inch open-end wrench (figs. 99 and 100). Remove the three mounting cap screws and lock washers with a $\frac{7}{8}$ -inch open-end wrench (fig. 101). Remove the starting motor and solenoid as an assembly. The adapter will come off with the starting motor.

e. To Install the Starting Motor.

Wrench, open-end, $\frac{7}{8}$ -in.

Wrench, open-end, $\frac{7}{8}$ -in.

Wrench, open-end, $\frac{3}{4}$ -in.

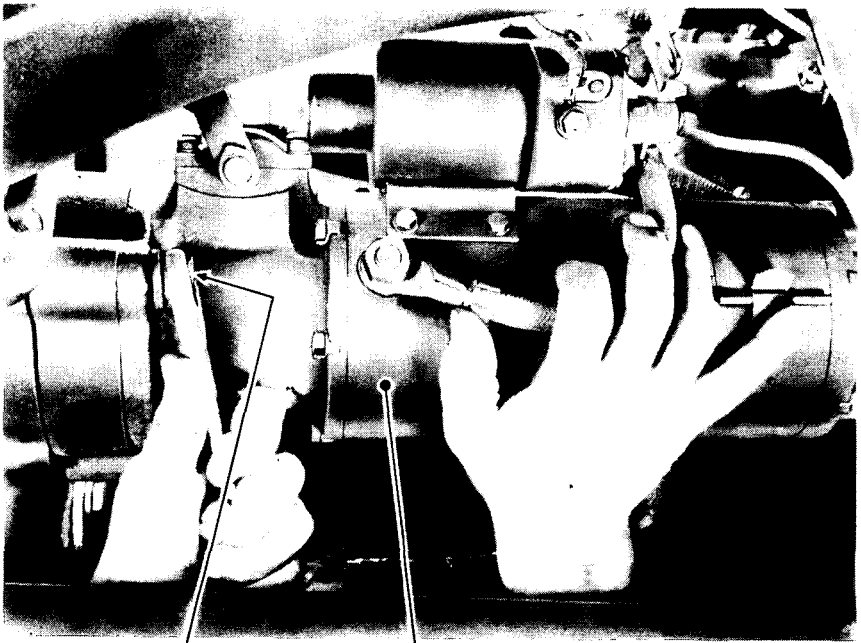

MOUNTING CAP SCREW
AND LOCK WASHER

STARTING MOTOR

RA PD 13055

Figure 101 — Starting Motor - Removal - (Hercules Diesel)

SCOUT CAR M3A1

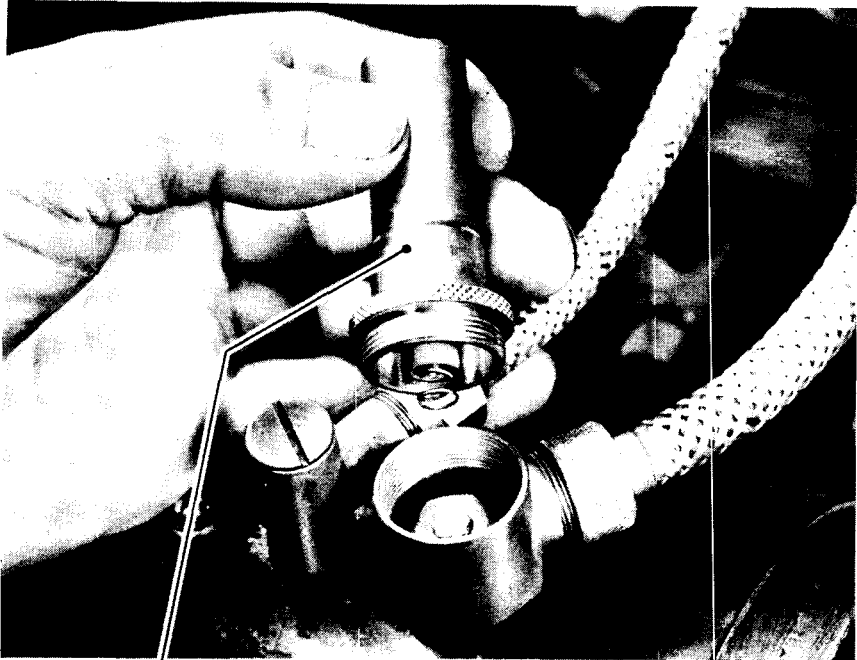

CONDENSER

RA PD 13141

Figure 102 — Removing Condenser from Armature Terminal

Place the starting motor and adapter in position on the bell housing, and using a $\frac{1}{8}$ -inch open-end wrench, tighten the three cap screws and lock washers (fig. 101). Connect the two large terminals, using a $\frac{3}{4}$ -inch open-end wrench, and the small terminal, using a $\frac{7}{16}$ -inch open-end wrench.

119. GENERATOR.

a. Description. The generator is a heavy-duty, four-brush unit, and is belt driven clockwise with the radiator fan pulley from the engine crankshaft. Belt tension is maintained by adjusting the slotted supporting strap. The terminals are shielded to reduce radio interference. Maximum cold output under control of the regulator is 55 amperes. A removable cover band around the field frame permits the inspection of the commutator and brush connections.

b. Maintenance and Adjustments. Refer to section XIX, paragraph 101 b.

c. Trouble Shooting. Refer to section XIX, paragraph 101 c.

**ELECTRICAL SYSTEM AND ACCESSORIES
(DIESEL ENGINE POWERED VEHICLES)**

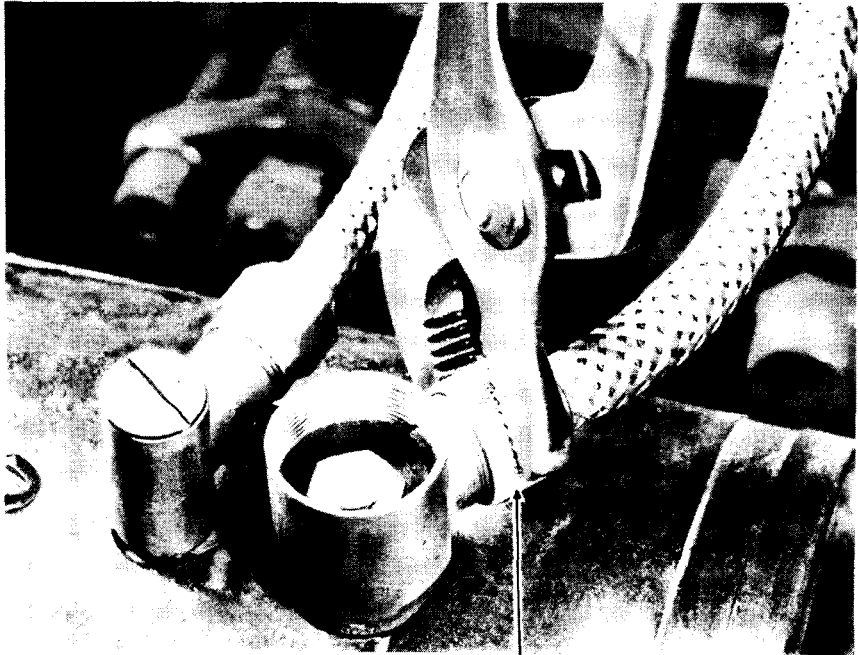

COUPLING NUT

RA PD 13142

Figure 103 — Removing Coupling Nut from Armature Terminal

d. Removal of Generator.

- | | |
|--------------------------------------|--------------------------------------|
| Pliers | Wrench, open-end, $\frac{3}{4}$ -in. |
| Screwdriver | Wrench, open-end, $\frac{7}{8}$ -in. |
| Screwdriver, heavy | Wrench, socket, $\frac{3}{8}$ -in. |
| Wrench, open-end, $\frac{5}{8}$ -in. | Wrench, socket, $\frac{1}{16}$ -in. |

(1) DISCONNECT THE ARMATURE TERMINAL.

- | | |
|--------|--|
| Pliers | Wrench, socket, $\frac{9}{16}$ -in., with ratchet handle |
|--------|--|

Using pliers, unscrew the condenser from the armature terminal (fig. 102). This is the larger terminal. Use pliers to unscrew the coupling nut (fig. 103). Using a $\frac{9}{16}$ -inch socket wrench with ratchet handle, remove the nut holding the wire to the terminal (fig. 104). Remove the wire from the generator terminal.

(2) DISCONNECT FIELD TERMINAL.

- | | |
|--------------------------------------|---|
| Screwdriver | Wrench, socket, $\frac{3}{8}$ -in., with $\frac{1}{4}$ -in. drive |
| Wrench, open-end, $\frac{5}{8}$ -in. | |

SCOUT CAR M3A1

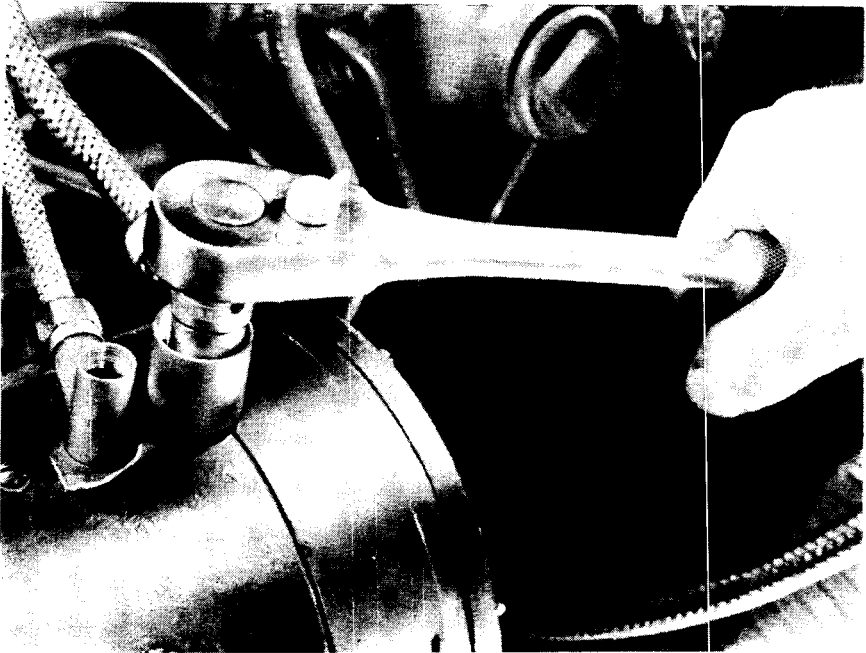
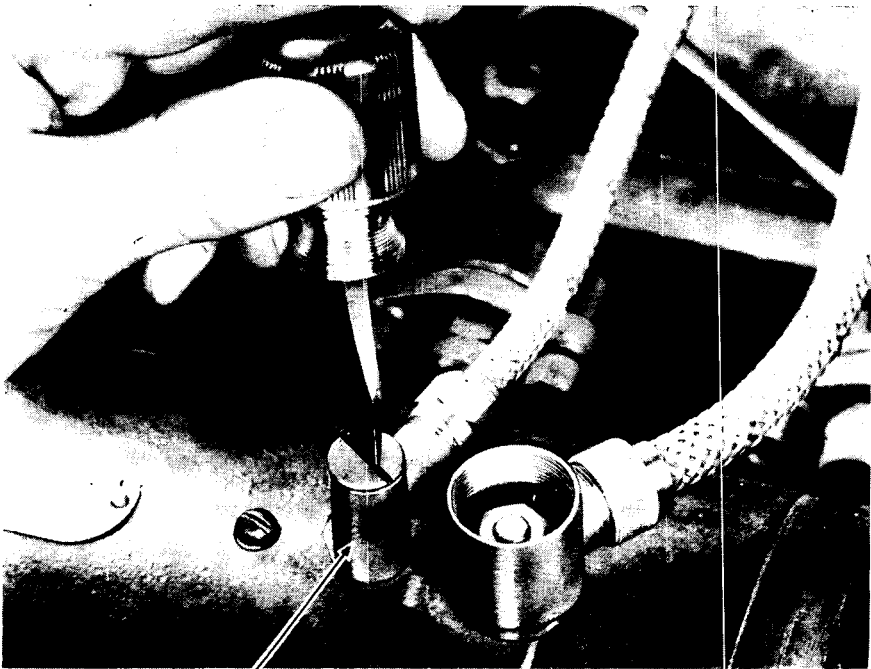

Figure 104 — Removing Armature Terminal

RA PD 13143



FIELD TERMINAL

Figure 105 — Removing Plug from Field Terminal

RA PD 13144

**ELECTRICAL SYSTEM AND ACCESSORIES
(DIESEL ENGINE POWERED VEHICLES)**

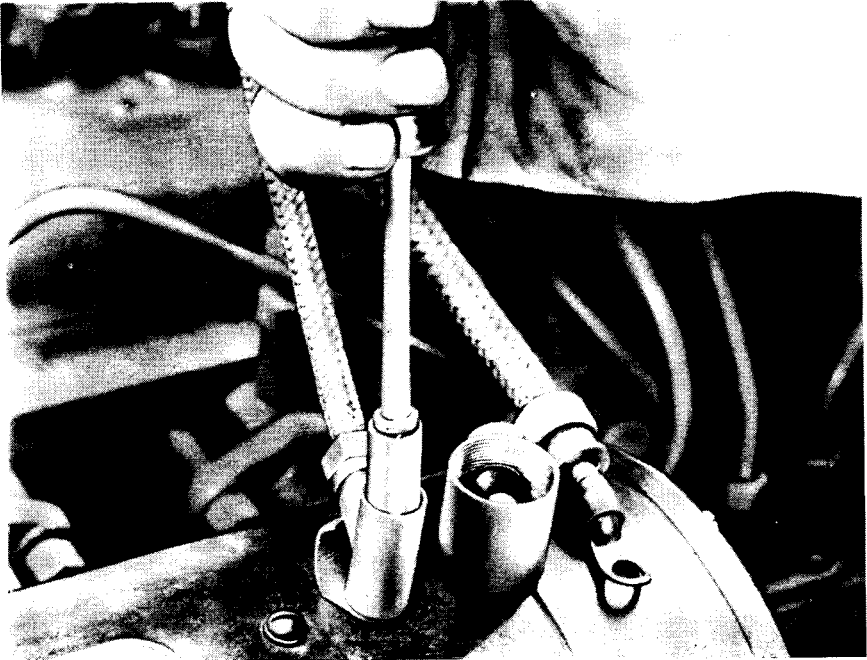

Figure 106 — Disconnecting Generator Field Terminal

RA PD 13145



Figure 107 — Removing Coupling Nut on Field Terminal

RA PD 13146

SCOUT CAR M3A1

Using a screwdriver, remove the plug from the field terminal (fig. 105), which is the smaller terminal. Using a special $\frac{1}{4}$ -inch drive with a $\frac{3}{8}$ -inch socket, remove the nut holding the lead to the field terminal (fig. 106), and with a $\frac{5}{8}$ -inch open-end wrench, unscrew wire shielding and remove the field wire (fig. 107).

(3) LOOSEN AND REMOVE THE GENERATOR BELTS.

Wrench, open-end, $\frac{3}{4}$ -in.

Using a $\frac{3}{4}$ -inch open-end wrench, remove the bolt, nut and lock washer from the generator adjusting strap (fig. 108). Then, using the same wrench, loosen the bracket at the fan base assembly, and move the bracket out of the way. Loosen the bolts on the generator base, using the $\frac{3}{4}$ -inch open-end wrench, and rotate the generator toward the engine. Slip the generator belts off the generator pulley (fig. 111).

(4) REMOVE GENERATOR FROM GENERATOR SUPPORT.

Wrench, open-end, $\frac{3}{4}$ -in.

Wrench, open-end, $\frac{7}{8}$ -in.

Swing the generator away from the engine block, resting it on the



RA PD 13030

Figure 108 — Loosening Fan Belt Adjusting Strap Bolt - (Hercules Diesel)

**ELECTRICAL SYSTEM AND ACCESSORIES
(DIESEL ENGINE POWERED VEHICLES)**

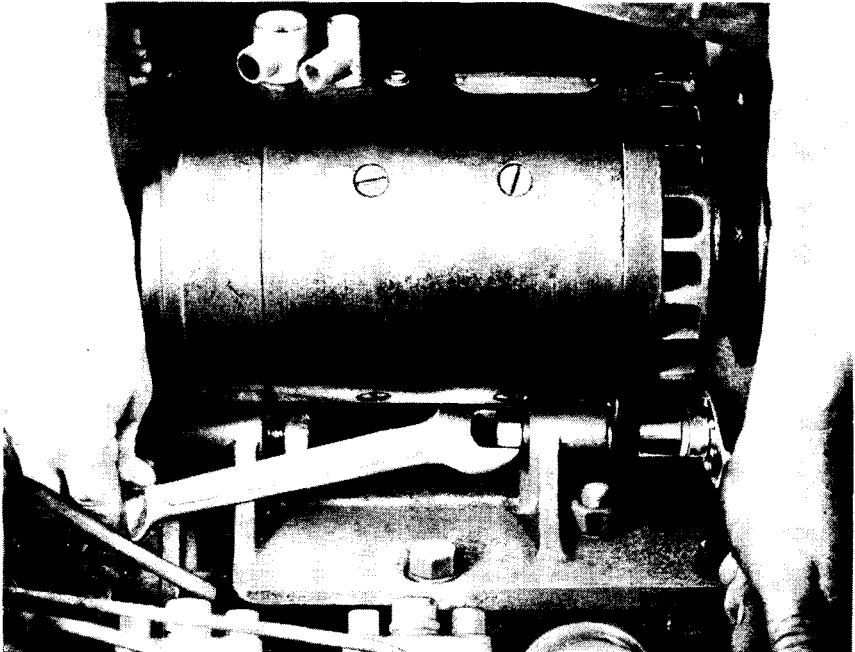

RA PD 13147

**Figure 109 — Removing Generator Bracket Holding Bolts -
(Hercules Diesel)**

frame. Remove the two nuts, lock washers and bolts that hold the generator to the generator support, using a $\frac{3}{4}$ -inch open-end wrench on the bolt heads, and a $\frac{7}{8}$ -inch open-end wrench on the nuts (figs. 109 and 110). Lift out the generator.

e. Installing Generator on Engine.

Screwdriver

Wrench, open-end, $\frac{3}{8}$ -in.

Wrench, open-end, $\frac{5}{8}$ -in.

Wrench, open-end, $\frac{7}{8}$ -in.

Wrench, open-end, $\frac{3}{4}$ -in.

Wrench, socket, $\frac{3}{8}$ -in., with
 $\frac{1}{4}$ -in. drive

(1) INSTALL GENERATOR BELTS.

Wrench, open-end, $\frac{3}{4}$ -in.

Wrench, open-end, $\frac{7}{8}$ -in.

Place the generator in position and line up the holes in the generator end cover bosses with the holes in the bracket base. Insert the bolts. Place lock washers and nuts on the bolts. Use hands, as nuts should not be tightened. Push the generator towards the engine as far as it will go and put on generator drive belts. Insert bolt with plain washer through

SCOUT CAR M3A1

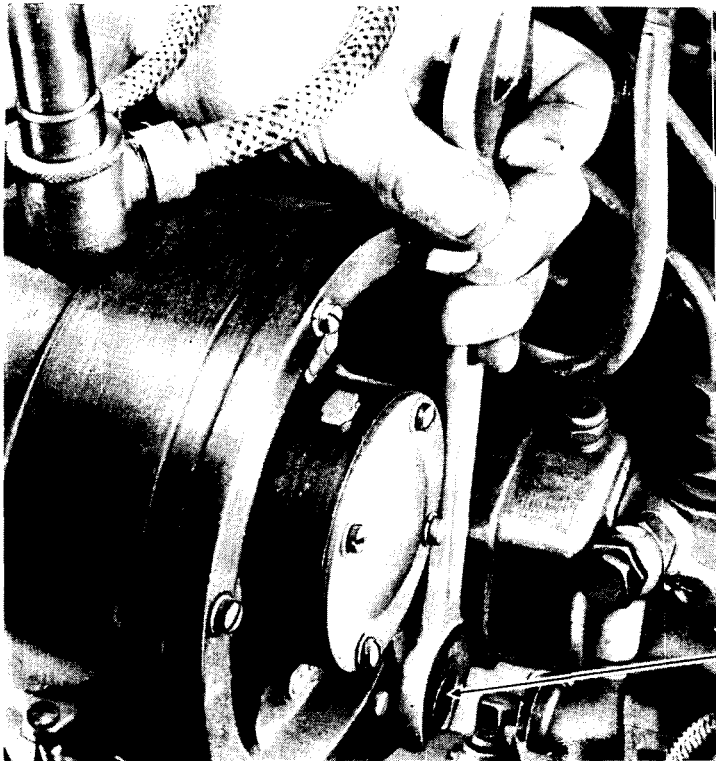

RA PD 13032

**Figure 110 — Removing Generator Bracket Holding Bolt -
(Hercules Diesel)**

the slotted end of the adjusting strap and generator housing boss. Place the lock washer and nut on the bolt with the hands. Pull the generator away from the engine until the fan belts may be moved up and down about $\frac{1}{2}$ inch, halfway between the fan pulley and generator pulley at the top. Tighten the adjusting strap bolt nut with a $\frac{3}{4}$ -inch open-end wrench. Then tighten the two lower bracket base bolt nuts with the $\frac{7}{8}$ -inch open-end wrench.

(2) CONNECT THE FIELD TERMINAL.

Screwdriver

Wrench, open-end, $\frac{5}{8}$ -in.

Wrench, socket, $\frac{3}{8}$ -in., with

$\frac{1}{4}$ -in. drive

Install the field wire and screw the wire shielding into place, using a $\frac{5}{8}$ -inch open-end wrench. Then, using a special $\frac{1}{4}$ -inch drive with a $\frac{3}{8}$ -inch socket, install the nut holding the lead to the field terminal. Install the plug in the field terminal, using a screwdriver.

**ELECTRICAL SYSTEM AND ACCESSORIES
(DIESEL ENGINE POWERED VEHICLES)**

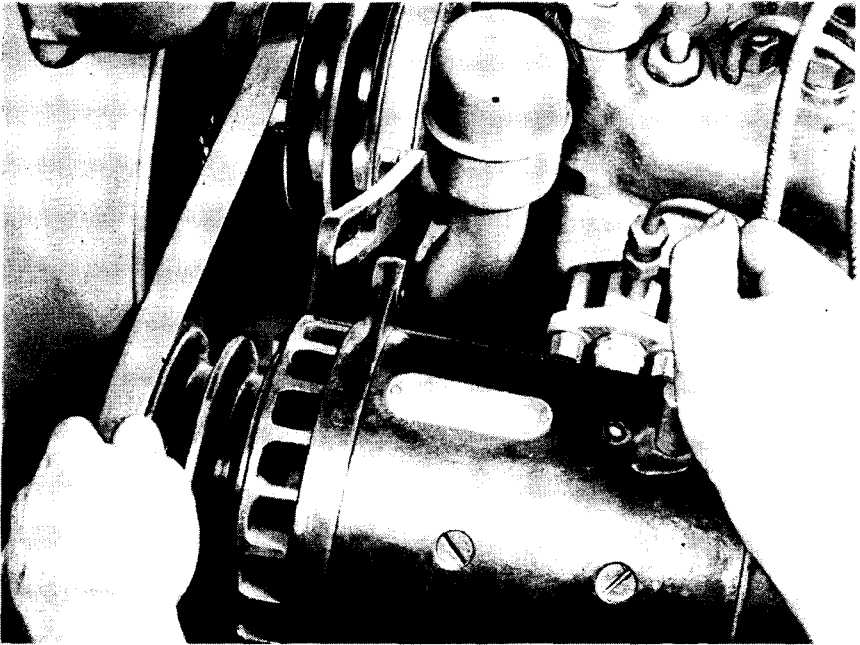

RA PD 13148

**Figure 111 — Removing Belts from Generator Fan Pulley -
(Hercules Diesel)**

(3) CONNECT THE ARMATURE TERMINAL.

Pliers

Wrench, socket, $\frac{9}{16}$ -in., with
ratchet handle

Install the wire on the generator terminal (the large terminal) and, using a $\frac{9}{16}$ -inch socket wrench with ratchet handle, install the nut holding the wire to the terminal, and screw on the coupling nut. Screw the condenser onto the armature terminal, using pliers.

120. VOLTAGE REGULATOR AND FILTER.

See section XIX, paragraph 102.

121. SERIES-PARALLEL SWITCH (figs. 112 and 113).

The series-parallel switch is provided for 12-volt operation of lights, horn, etc., with the full 24-volt capacity of the electrical system available for starting. The operation of the switch to the 24-volt system is automatic with the depression of the starter button. To replace the

SCOUT CAR M3A1

switch, disconnect the seven leads and remove the four nuts, lock-washers and bolts ($\frac{7}{16}$ -in. wrench).

122. SHIELDING.

a. **Description.** In order that sensitive radio equipment may be operated without interference, the wiring system of the vehicle is completely shielded and the shielding is grounded. Standard unshielded automotive cable, with eyelet terminals and rubber sleeves, is within the flexible metallic conduit. Knurled coupling nuts may be turned by hand.

b. **Precautions.** See section XIX, paragraph 106 b.

c. **Maintenance.** See section XIX, paragraph 106 c.

123. FUSES.

See section XIX, paragraph 109.

124. ELECTRICAL SYSTEM TROUBLE SHOOTING.

See section XIX, paragraphs 100 c and 101 c.

125. SWITCHES.

a. **Starter.** This switch, located on the instrument panel, operates the magnetic switch which controls the starting motor.

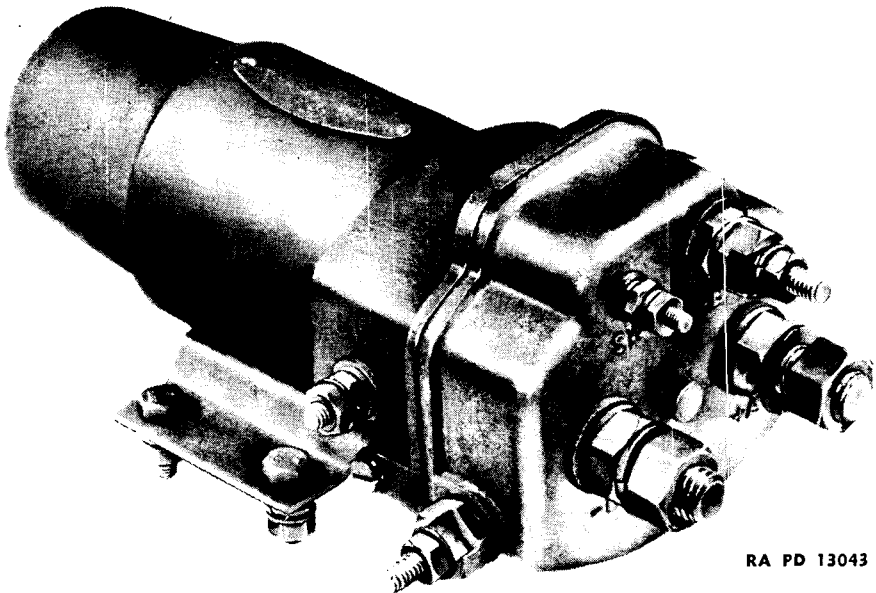

**Figure 112 — Series Parallel Switch - Right Side View -
(Hercules Diesel)**

**ELECTRICAL SYSTEM AND ACCESSORIES
(DIESEL ENGINE POWERED VEHICLES)**

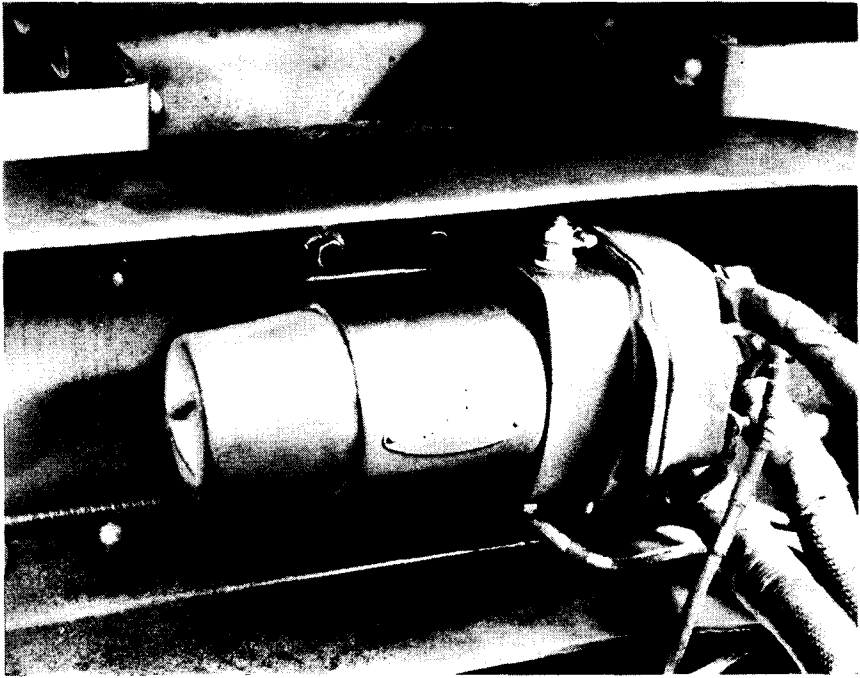

RA PD 13031

Figure 113 — Series Parallel Switch - Installed - (Hercules Diesel)

b. For stop light, head lamp beam, panel lights, heater, voltmeter, fuel gage, horn button, and light switches see section XIX, paragraph 110.

126. TERMINAL BOX.

See section XIX, paragraph 111.

127. HEAD LAMPS.

See section XIX, paragraph 112.

128. TAIL LAMPS.

See section XIX, paragraph 113.

129. HEATER.

See section XIX, paragraph 114.

130. HORN.

See section XIX, paragraph 115.

SCOUT CAR M3A1

Section XXI

ENGINE (HERCULES GASOLINE)

	Paragraph
General description	131
Characteristics	132
Trouble shooting	133
Tune up	134
Cylinder head removal.....	135
Cylinder head installation.....	136
Flywheel marking	137
Removal and installation of manifold.....	138
Removal and installation of oil pan.....	139
Oil pump	140
Valves	141
Removal and installation of valves.....	142
Cleaning carbon	143
Engine removal	144
Engine installation	145

131. GENERAL DESCRIPTION.

The gasoline engine is of the four-cycle, six-cylinder-in-line, L-head type. The engine serial number is stamped on a name plate on the right-side of the engine. Cylinders are numbered from front to rear, the engine front (fan and timing gear end) being toward the front of the vehicle. As viewed from the front end, engine crankshaft rotation is clockwise.

132. CHARACTERISTICS.

Model.....	Hercules JXD
Cylinders	6
Bore	4-in.
Stroke	4 $\frac{1}{4}$ -in.
Displacement (cubic inches).....	320
Compression ratio	5.88 to 1
Automotive Manufacturers' Association horsepower.....	38.4
Brake horsepower at 3,000 rpm.....	110
Maximum torque at 1,100 rpm (foot-pounds).....	241
Crankcase capacity (quarts)	6
Oil filler location.....	Front upper left side
Oil drain location.....	Bottom of oil pan
Oil pressure regulation.....	Spring-regulated valve
Water drain locations.....	Bottom of water pump and rear lower left side
Cooling system capacity, quarts.....	19
*Weight in pounds (less accessories).....	650

* Includes engine, flywheel, timing drive, oil and water pumps.

ENGINE (HERCULES GASOLINE)

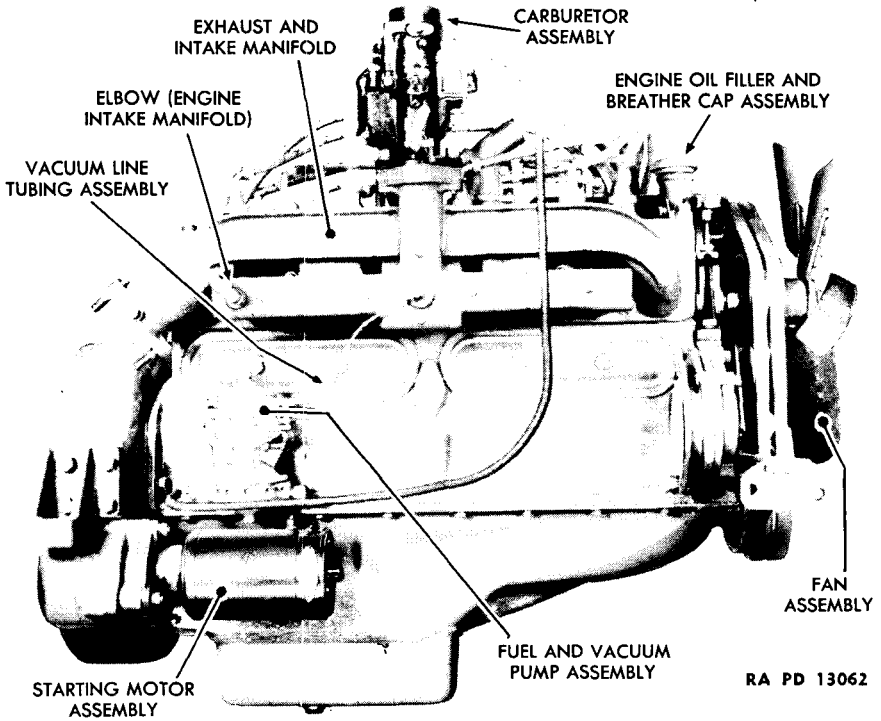

Figure 114 — Hercules Gasoline Engine - Right Side

133. TROUBLE SHOOTING.

In order to locate and correct a malfunction or fault in an engine, operating personnel should understand the fundamental principles of engine operation, recognize and identify fundamental trouble symptoms, and be prepared to follow a systematic procedure of diagnosis to eliminate the tedious guess work of a hit-or-miss search for the difficulty. The essential factors necessary for an engine to operate comprise cranking; fuel and air; compression; ignition; exhaust; proper lubrication and cooling; correct adjustments. Symptoms within the scope of this publication concern some of those indicated below.

a. Lack of Power.

- (1) **IGNITION SYSTEM DEFECTIVE.** Refer to section XIX, paragraph 108.
- (2) **CARBURETOR OR FUEL PUMP FUNCTIONING IMPROPERLY.** Refer to section XXVI, paragraph 187 b and c.
- (3) **FUEL FILTER FOREIGN MATTER.** Empty and clean.
- (4) **AIR CLEANER RESTRICTION.** Renew oil and clean.

SCOUT CAR M3A1

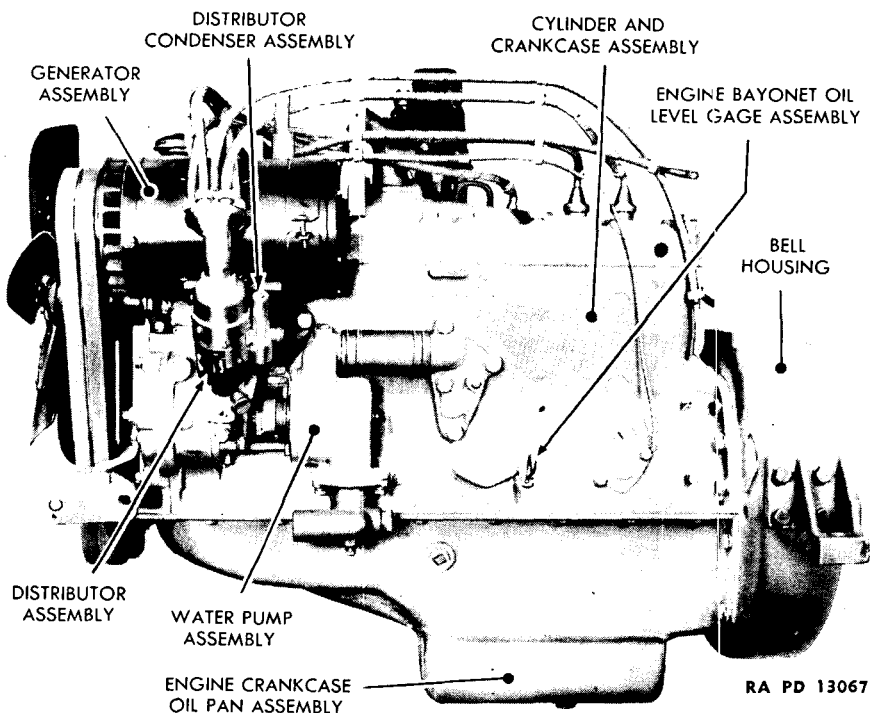

Figure 115 — Hercules Gasoline Engine - Left Side

- (5) OVERHEATING. Refer to section XVI, paragraph 76 a and 80.
- (6) TOO COLD. Refer to section XVI, paragraph 81.

h. Overheating.

- (1) COOLING SYSTEM DEFECTIVE. Refer to section XVI, paragraph 76 a.
- (2) FUEL MIXTURE. (Refer to section XXVI, paragraph 187 b (4)).
- (3) IGNITION SYSTEM DEFECTIVE. Refer to section XIX.

c. Excessive Oil Consumption.

- (1) OVERHEATING. Refer to section XVI.
- (2) IMPROPER GRADE OF OIL. Change oil.
- (3) OIL LEAKS AT GASKETS AND SEALS. Check and tighten, or replace.

d. Low Oil Pressure.

- (1) IMPROPER GRADE OF OIL. Change.
- (2) OIL PUMP SCREEN CLOGGED. Remove oil pan and clean.

ENGINE (HERCULES GASOLINE)

e. Popping, Spitting, and Spark Knock.

(1) **MANIFOLD HEAT CONTROL DEFECTIVE.** Refer to ordnance personnel.

(2) **IGNITION SYSTEM DEFECTIVE.** Refer to section XIX, paragraph 108.

(3) **CARBURETOR IMPROPERLY ADJUSTED.** Refer to ordnance personnel.

(4) **EXCESSIVE CARBON DEPOSITS.** Clean.

(5) **INFERIOR GRADE OF FUEL.** Change.

134. TUNE-UP.

Before an engine tune-up is accomplished, a test of the engine compression should be made, since excessively uneven compression in the cylinders makes successful tuning impossible.

a. **Spark Plugs.** Check for proper size and heat range; fouled gap; cracked porcelain; gap settings.

b. **Battery and Ignition Cables.** Inspect ground strap and starter cable; check ignition wiring and shielding; terminals must be tight and clean.

c. **Distributor.** Inspect points for evidence of pitting or burning; check gap and cam; inspect cap for cracks and pitted posts; check operation and movement of centrifugal weights; check condenser.

d. **Carburetor.** Clean air cleaner and filter; check for leaks; adjust idling screws, if necessary; check manifold heat control; check connections of controls.

e. **Timing.** Check ignition timing.

135. CYLINDER HEAD REMOVAL

Hammer, fiber

Wrench, open-end, 1/2-in.

Handle, speed

Wrench, open-end, 5/8-in.

Pail

Wrench, socket, 3/4-in.

Pliers

Wrench, spark plug

Screwdriver

a. Drain Block.

Pail

Pliers

Open drain cock and drain water or antifreeze into pail.

b. Remove Upper Radiator Hose Connection.

Screwdriver.

Loosen clamp on upper radiator hose and pull hose loose from cylinder head.

SCOUT CAR M3A1**c. Remove Heater Inlet Hose.**

Screwdriver.

Loosen clamp holding inlet hose to cylinder head connection and pull off hose.

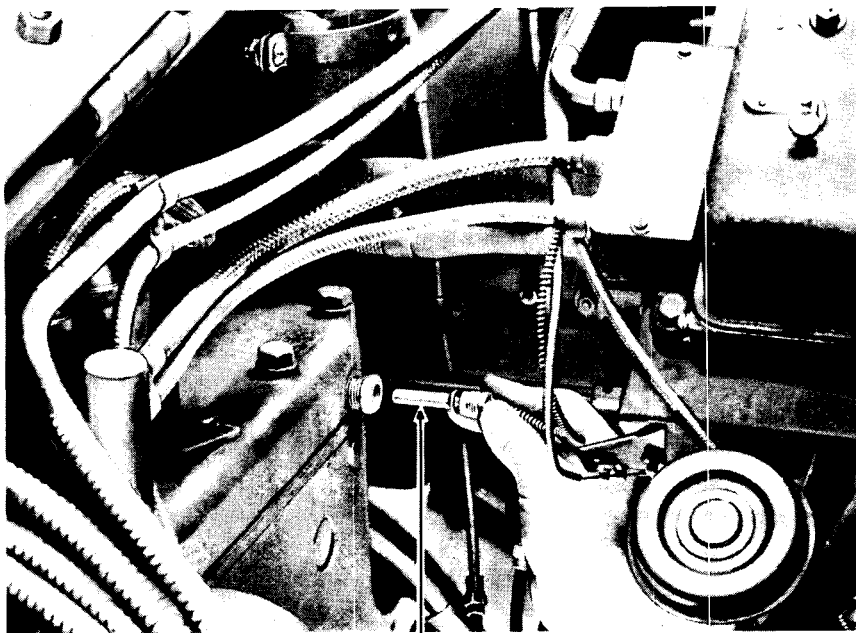

HEAT
INDICATOR
UNIT

RA PD 13024

Figure 116 — Removing Heat Indicator Unit from Cylinder Head - (Gasoline Engine)

d. Remove Heat Indicator Unit Assembly (fig. 116).Wrench, open-end, $\frac{5}{8}$ -in.

Loosen temperature gage bulb adapter nut at rear left side of engine cylinder head and pull out bulb from adapter.

e. Disconnect Spark Plug Shielding.

Pliers

Wrench, socket, $\frac{3}{4}$ -in.

Unscrew shielding nuts at all spark plug shieldings. Remove cap screws that hold the shielding conduit support bracket to cylinder head. Remove brackets and shielding assembly.

f. Remove Spark Plugs.

Wrench, spark plug

Remove all spark plugs and their shielding.

ENGINE (HERCULES GASOLINE)

g. Remove Oil Filler and Breather Extension Pipe.

Hammer, fiber

Wrench, open-end, $\frac{1}{2}$ -in.

Remove cap screw and plain washer that hold the pipe to the engine head clip. Then tap pipe with hammer, and lift out filler and breather extension pipe, and cap assembly.

h. Remove Cylinder Head.

Wrench, socket, $\frac{3}{4}$ -in., with speed handle

Loosen the cylinder head cap screws with a $\frac{3}{4}$ -inch socket wrench. After they have been loosened, they can be removed faster with a $\frac{3}{4}$ -inch socket wrench fitted with a speed handle. The oil filler and breather clip and heater hose brackets come off when their respective cap screws are removed. After the cap screws have been removed, the cylinder head and gasket can be removed.

136. CYLINDER HEAD INSTALLATION.

Hammer, fiber

Wrench, open-end, $\frac{5}{8}$ -in.

Handle, speed

Wrench, socket, $\frac{3}{4}$ -in.

Pliers

Wrench, spark plug

Screwdriver

Wrench, tension

Wrench, open-end, $\frac{1}{2}$ -in.

a. Install the Cylinder Head.

Wrench, socket, $\frac{3}{4}$ -in.

Wrench, tension

Use a new gasket when installing the cylinder head. Place the cylinder

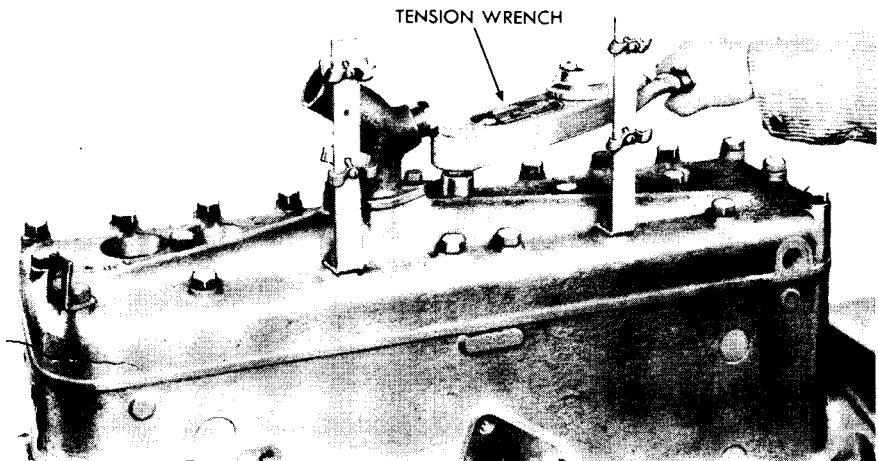

RA PD 13028

Figure 117 — Tightening Cylinder Head Cap Screws -
(Gasoline Engine)

SCOUT CAR M3A1

head in position on the cylinder block and secure with the cap screws. No lock washers are used. Be sure to install the two conduit brackets and the oil filler and breather clip in their proper locations with the cylinder head cap screws. The cylinder head cap screws should be tightened in rotation, a few turns at a time, beginning at the center of the head and working to the outside. They should be tightened with a tension wrench to a tension of $52\frac{1}{2}$ foot-pounds (fig. 117). The final tightening should be done after the engine has been run and is thoroughly warmed up, and the tension readings should be checked after 500 miles of vehicle operation.

b. Install Oil Filler and Breather Extension Pipe.

Hammer, fiber Wrench, open-end, $\frac{1}{2}$ -in.

Tap oil filler and breather extension pipe into position in engine block and fasten to clip on cylinder head with a cap screw and plain washer.

c. Install Spark Plugs.

Wrench, spark plug

Install spark plugs with gaskets and shielding in cylinder head. Care should be taken not to make spark plugs too tight, to prevent damage to cylinder head threads.

d. Connect Spark Plug Shielding.

Pliers

Attach spark plug conduits to respective spark plug shields with shielding nuts.

e. Install Heat Indicator Unit Assembly.

Wrench, open-end, $\frac{5}{8}$ -in.

Insert bulb into adapter at rear left side of engine cylinder head and secure by tightening adapter nut (fig. 116).

f. Connect Heater Inlet Hose.

Screwdriver

Force hose onto cylinder head heater connection and secure with clamps. Then clamp hoses to cylinder head hose brackets.

g. Connect Upper Radiator Hose.

Screwdriver

Force the hose cylinder head connections and secure with clamps.

137. FLYWHEEL MARKING.

The flywheel is marked "DC" to indicate top dead center for No. 1 piston, and is visible through the flywheel timing hole which is located on the left side of the engine in the flywheel housing.

ENGINE (HERCULES GASOLINE)

138. REMOVAL AND INSTALLATION OF MANIFOLD.

a. Removal.

Wrench, open-end, $\frac{3}{8}$ -in.

Wrench, open-end, $\frac{7}{8}$ -in.

Wrench, open-end, $\frac{5}{8}$ -in.

Wrench, socket, $\frac{5}{8}$ -in.

(1) REMOVE CARBURETOR. Refer to paragraph 185.

(2) DISCONNECT LINE.

Wrench, open-end, $\frac{3}{8}$ -in.

Wrench, open-end, $\frac{7}{8}$ -in.

Wrench, open-end, $\frac{5}{8}$ -in.

Disconnect vacuum line to dash at the rear of intake manifold. Disconnect vacuum line to fuel pump at intake manifold. Remove two brass nuts holding exhaust pipe to manifold.

(3) REMOVE MANIFOLD.

Wrench, socket, $\frac{5}{8}$ -in.

Remove the ten brass nuts and washers from the manifold studs and lift off manifold and gaskets.

b. Installation.

Wrench, open-end, $\frac{3}{8}$ -in.

Wrench, open-end, $\frac{7}{8}$ -in.

Wrench, open-end, $\frac{5}{8}$ -in.

Wrench, socket, $\frac{5}{8}$ -in.

(1) SECURE MANIFOLD IN PLACE.

Wrench, open-end, $\frac{5}{8}$ -in.

Wrench, socket, $\frac{5}{8}$ -in.

Place the manifold in position on the studs, using a new gasket. Install the plain washers, and secure the manifold in position with the brass nuts.

(2) CONNECT LINES.

Wrench, open-end, $\frac{3}{8}$ -in.

Wrench, open-end, $\frac{7}{8}$ -in.

Wrench, open-end, $\frac{5}{8}$ -in.

Connect the exhaust pipe to the manifold with the two nuts. Connect the vacuum line to the fuel pump at the manifold. Connect the vacuum line to dash at the rear of the intake manifold.

(3) INSTALL THE CARBURETOR. Refer to paragraph 185.

139. REMOVAL AND INSTALLATION OF OIL PAN.

~~Wrench~~ Wrench, open-end, $\frac{3}{4}$ -in.

Wrench, socket, $\frac{9}{16}$ -in., with speed handle.

a. Removal.

Wrench, open-end, $\frac{3}{4}$ -in.

Wrench, socket, $\frac{9}{16}$ -in., with speed handle.

Drain oil. Remove the 20 cap screws and lock washers that hold the oil pan to the crankcase ($\frac{9}{16}$ -inch socket wrench with speed handle). Using a $\frac{3}{4}$ -inch open-end wrench remove the five cap screws and lock

SCOUT CAR M3A1

washers that hold the oil pan to the flywheel housing. Lift off the oil pan with its gasket.

b. Installation.

Wrench, open-end, $\frac{3}{4}$ -in.

Wrench, socket, $\frac{9}{16}$ -in., with speed handle.

Shellac a new gasket to the mounting flange of the oil pan. Place the oil pan in position on the crankcase and up against the face of the bell housing. Insert the five cap screws fitted with lock washers in the pan and bell housing. Tighten with a $\frac{3}{4}$ -inch open-end wrench. Install the 20 cap screws, fitted with lock washers, in the pan and crankcase. Tighten these with a $\frac{9}{16}$ -inch socket wrench fitted with a speed handle.

140. OIL PUMP.

a. **Description.** The lubricating oil pump is of the gear type, bolted to the center main bearing web and driven from the camshaft. The suction tube extends into the oil reservoir in the oil pan and needs no priming, but its oil strainer must not become clogged. Oil pressure should be 26 pounds at normal engine speed, and about 35 pounds at high speed.

b. Removal.

Wrench, open-end, $\frac{9}{16}$ -in.

Remove oil pan (par. 139). Remove three cap screws and lock washers that hold the oil pump to main bearing web. Turn pump $\frac{1}{4}$ turn counterclockwise and lift out pump assembly and gasket.

c. Installation.

Wrench, open-end, $\frac{9}{16}$ -in.

Place pump and new gasket in position and turn pump $\frac{1}{4}$ turn clockwise. Install three cap screws and lock washers to hold pump to main bearing web. Install oil pan (par. 139).

141. VALVES.

Valves are of the poppet type with a 45-degree angle seat. The inlet valves are of chrome-nickel steel, and the exhaust valves are of ~~silchrome~~ steel. The valves are actuated by the cams through the valve tappets which are of the mushroom type and provided with a suitable screw and lock nut to facilitate adjustment of the valve stem clearance. Valve tappet adjustment or clearance should be made with the engine hot and should be set at 0.006 inch for both intake and exhaust. When checking or setting the valve clearance, crank the engine to the firing position for each cylinder before setting the valves on that cylinder.

ENGINE (HERCULES GASOLINE)

142. REMOVAL AND INSTALLATION OF VALVES.

Lifter, valve spring
Pliers, round-nosed
Rack, valve

Screwdriver
Wrench, socket, 3/4-in.

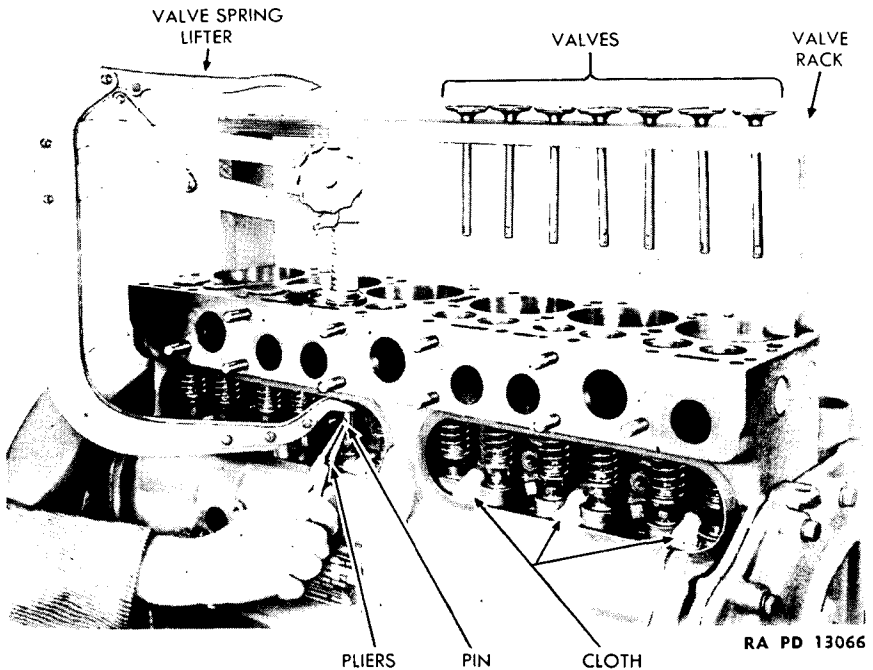

Figure 118 — Removing Valves - (Gasoline Engine)

a. Valve Removal.

Lifter, valve spring
Pliers, round-nosed

Rack, valve

- (1) Remove cylinder head (par. 135).
- (2) Remove valve chamber cover.
- (3) Place pieces of cloth in the openings in the crankcase (fig. 118), so that none of the parts being removed can drop down into the crankcase and oil pan.
- (4) Place the valve spring lifting tool in position, with the jaw of the tool under the valve spring retaining washer and the top of the tool centered on the valve head (fig. 118).
- (5) Press down on the handle of the tool until the valve spring is

SCOUT CAR M3A1

fully compressed, so that the valve pin will be accessible for removal. Remove the pin with round-nosed pliers or with the fingers.

(6) Lift out the valves and place them in a rack suitably marked, so that the valves will be put back in their proper places.

(7) NOTE: It is advisable to rotate the crankshaft to a position where each valve to be removed is in the fully closed position; otherwise the valve spring will not be compressed enough to allow removal of the keeper or pin.

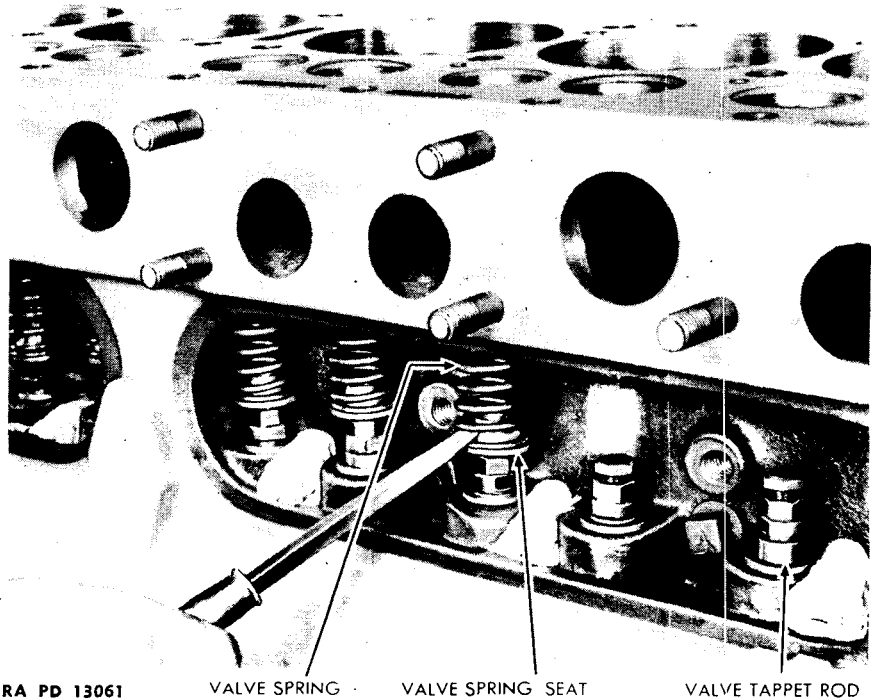

Figure 119 — Removing Valve Springs - (Gasoline Engine)

b. Valve Spring Removal.

Screwdriver

(1) To remove the valve springs and valve spring seats, place a screwdriver under one of the lower coils of the spring (fig. 119). Be sure the screwdriver is in far enough to get a "purchase" on the top of the spring seat.

(2) Pry up with the screwdriver until the spring and spring seat clear the valve tappets.

(3) Pull outward, and the spring and seat will come out (fig. 120).

ENGINE (HERCULES GASOLINE)

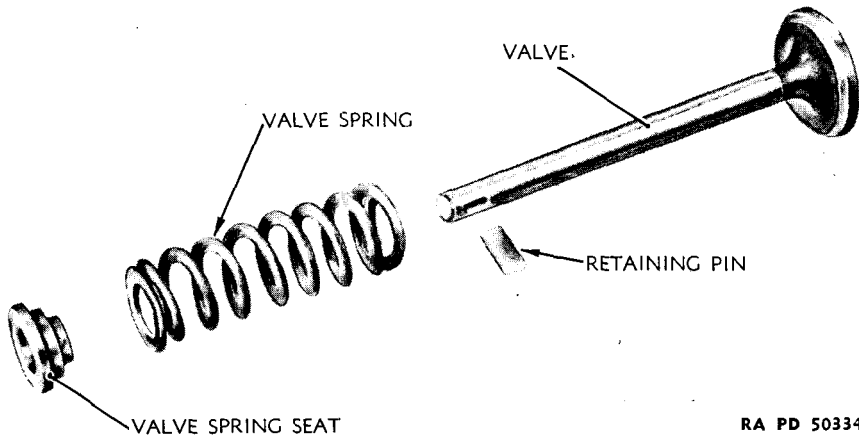

RA PD 50334

Figure 120 — Valve Group Details - (Gasoline Engine)

c. Grinding Valves. Valves and seats may be ground (lapped) as follows:

(1) Place each valve in its proper valve opening in the cylinder block.

(2) Place a small amount of lapping compound around the face of the valve.

(3) Rotate the valve back and forth on its seat with a hand or electric valve grinding tool until a finished surface is secured (fig. 121).

(4) Remove the valve and clean the compound from the valve and valve seat.

(5) Test valve for perfect contact with seat in cylinder block by marking lines about $\frac{1}{4}$ inch apart on the face of valve with a lead pencil. Insert valve in guide and give $\frac{1}{2}$ turn to the right and $\frac{1}{2}$ turn to the left. If all pencil marks are removed, the operation may be considered satisfactory. If one or more pencil marks remain untouched, the valve and seat should be reground until it seats properly.

d. Valve Installation.

Compressor, valve spring
Gage, feeler
Pliers

Wrench, open-end, $\frac{3}{4}$ -in.
Wrench, open-end, tappet adjusting $\frac{1}{2}$ -in.

SCOUT CAR M3A1

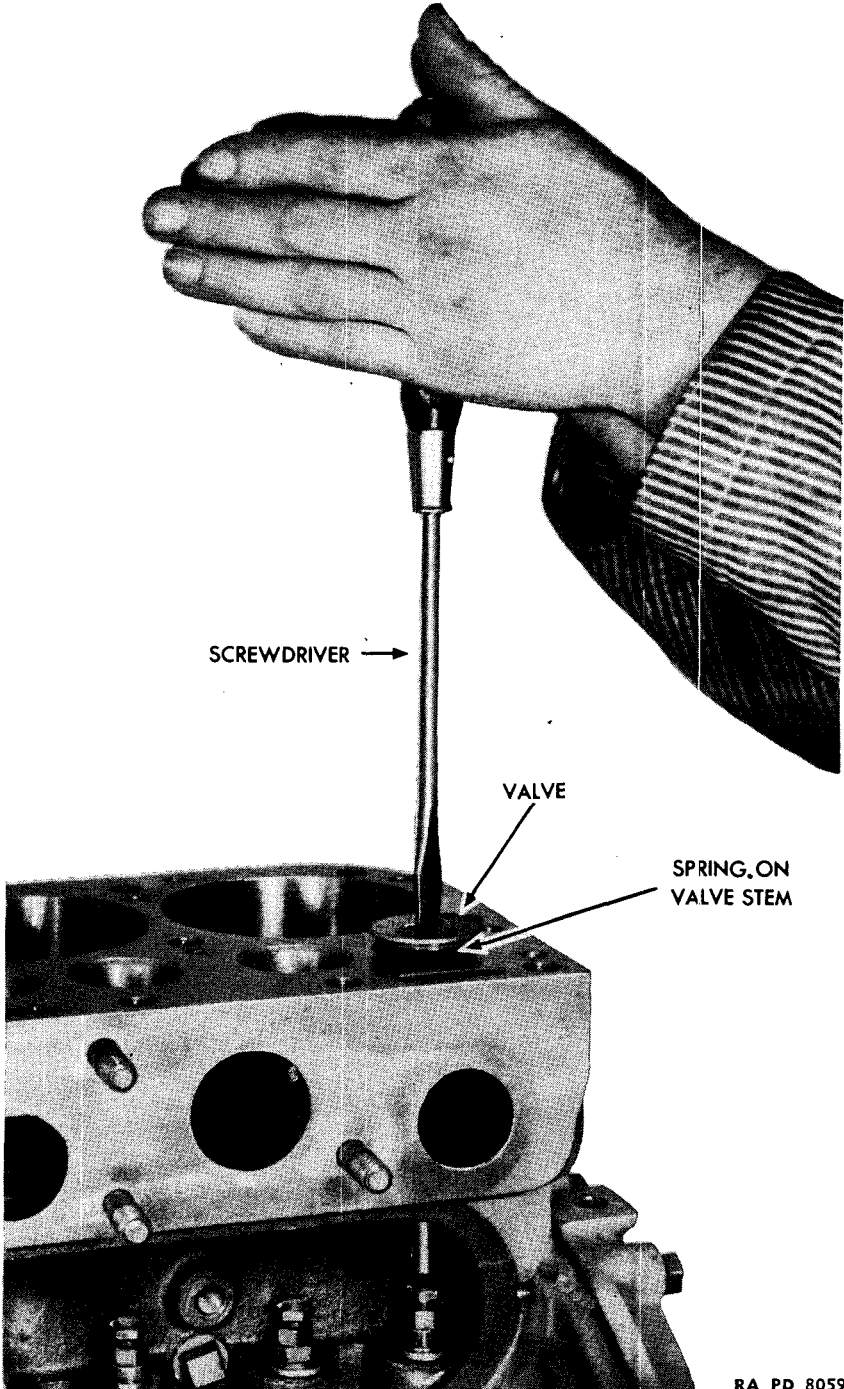

RA PD 8059

Figure 121 — Valve Grinding - (Gasoline Engine)

ENGINE (HERCULES GASOLINE)

- (1) Place the valve springs and seats in position over the ends of the valve tappets.
- (2) Place the valves in their respective positions in the cylinder block.
- (3) Place the valve spring compressor in position, with the jaw of the tool under the valve spring retaining washer or seat and the top of the tool on the valve head. Press down on the handle of the tool until the valve spring is fully compressed (fig. 118).
- (4) Insert the valve retaining pin in the valve stem with pliers, and release the tool.
- (5) Repeat this procedure until all valves are installed.
- (6) Remove the pieces of cloth from the crankcase openings.

e. Valve Tappet Adjustment (fig. 122).

Gage, feeler

Wrench, tappet adjusting (three)

Place feeler gage between the tappet and valve stem and adjust the tappet and lock nut with $\frac{1}{2}$ -inch open-end tappet adjusting wrenches. Adjust the valves at 0.008 in. to 0.010 in. with the engine COLD. The result will then be approximately 0.006-in. clearance with the engine

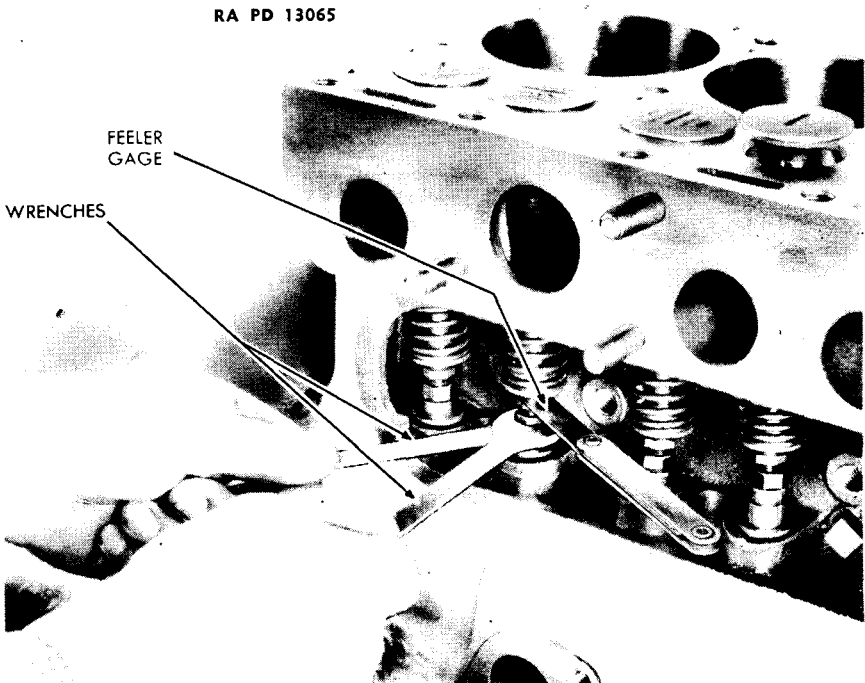

Figure 122 — Adjusting Valve Clearance - (Gasoline Engine)

SCOUT CAR M3A1

HOT. Tighten the lock nut when proper clearance is obtained. The valve tappet body and the adjusting screw must be held from turning when the lock nut is being tightened.

143. CLEANING CARBON.

Scraper
Screwdriver

Tool, carbon

a. Whenever the engine cylinder head is removed, the combustion chambers should be scraped clean of carbon accumulations. Any areas on top of the motor block which show carbon should be scraped and cleaned. Also scrape and clean the valve tops. When valves are removed, remove any accumulation from the stems.

b. Instead of hand-scraping, carbon can also be removed by using a wire brush designed for this work and fitted to a small electric drill tool.

144. ENGINE REMOVAL.

Blocks, wood	Wrench, open-end, $\frac{9}{16}$ -in. (two)
Hammer	Wrench, open-end, $\frac{5}{8}$ -in.
Handle, ratchet	Wrench, open-end, $\frac{3}{4}$ -in.
Hoist	Wrench, open-end, $\frac{7}{8}$ -in.
Pail	Wrench, open-end, $1\frac{1}{8}$ -in.
Pliers	Wrench, socket, $\frac{9}{16}$ -in.
Pliers, channellock	Wrench, socket, $\frac{3}{4}$ -in.
Rope, length of	Wrench, socket, $1\frac{5}{8}$ -in.
Screwdriver, heavy-duty square shank	Wrench, socket, $\frac{3}{8}$ -in. thin-walled
Screwdriver, thin	Wrench, socket, $\frac{7}{16}$ -in., thin-walled
Wrench, box, $\frac{9}{16}$ -in.	Wrench, socket, $\frac{9}{16}$ -in., with speed handle
Wrench, open-end, $\frac{3}{8}$ -in.	Wrench, socket, $\frac{7}{8}$ -in., with universal attachment
Wrench, open-end, $\frac{7}{16}$ -in.	
Wrench, open-end, $\frac{1}{2}$ -in.	

a. Drain Radiator.

Pail

Pliers

Open drain cocks on radiator, water pump and engine block and drain water or antifreeze into a pail.

b. Remove Hood.

Hoist

Rope, length of

Screwdriver, heavy-duty square shank

Wrench, open-end, $\frac{3}{16}$ -in.

Remove three elastic stop nuts and bolts at rear of center panel of hood. Remove nut and bolt on inside of shutter frame, near the top, on

ENGINE (HERCULES GASOLINE)

each side of frame. Use rope and hoist to lift off hood, with top of shutter frame left on hood. Hood can also be slipped over front of car by three men.

c. Remove Shutter Assembly.

Hoist, chain
Screwdriver, heavy-duty

Wrench, box, $\frac{9}{16}$ -in.
Wrench, open-end, $\frac{1}{2}$ -in.

Remove bolts and nuts that hold the shutter frame to the engine side-armor plates. Disconnect shutter control on lower right side of radiator. Lift shutter frame straight up and out.

d. Remove Radiator Hose Connections.

Screwdriver

Loosen clamps that secure the inlet and outlet radiator hoses, and pull hoses loose from radiator.

e. Remove Radiator.

Hoist, chain
Wrench, socket, $\frac{3}{4}$ -in.

Wrench, socket, $\frac{7}{8}$ -in., with
universal attachment

Disconnect radiator from cross member by removing holding stud nuts, springs, washers and pads. Then disconnect stay rods at frame by removing nuts from stay rod bolts underneath car on the bottom side of the top frame flange. Remove radiator assembly from car by lifting upward and slightly forward (fig. 48).

f. Remove Heater Inlet and Return Hoses.

Screwdriver

Loosen clamp that holds the inlet hose to the cylinder head connection and pull off hose. Then loosen clamp that holds the return hose to the water pump connection and the clip that holds the hose at the cylinder head. Pull hose from water pump connection.

g. Disconnect Battery.

Wrench, open-end, $\frac{9}{16}$ -in.

Remove cap screws and lock washers that secure the battery compartment cover. Loosen nuts that clamp the cables to battery terminals and pull off cables from terminals. Always pull off negative cable first (fig. 68). Tape cable terminals (fig. 69).

h. Remove Carburetor Air Intake Pipe.

Screwdriver
Wrench, open-end, $\frac{1}{2}$ -in.

Loosen clamp that holds hose to air cleaner outlet. Then loosen cap screws that hold air intake to carburetor air inlet. Lift intake pipe from carburetor and remove (fig. 123).

i. Remove Pipe Assembly (Fuel Pump to Carburetor).

Wrench, open-end, $\frac{1}{2}$ -in.

Disconnect flanged tube nuts at fuel filter inlet connection and at fuel pump outlet connection, and remove pipe assembly.

SCOUT CAR M3A1

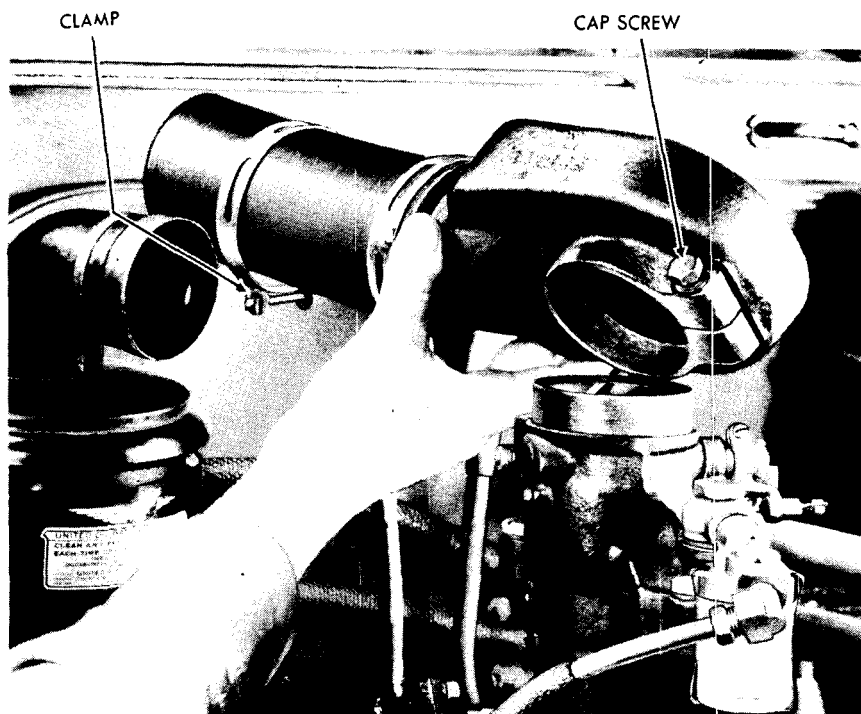

RA PD 13064

Figure 123 — Removing Air Intake Pipe from Air Filter - (Gasoline Engine)

j. Disconnect Carburetor Controls.

Screwdriver

Wrench, open-end, $\frac{7}{16}$ -in.

Remove nut and lock washer that hold throttle control rod to throttle lever, and lower rod. Then loosen screws that hold choke and throttle controls at carburetor, and pull out controls (fig. 124).

k. Remove Pipe Assembly (Check Valve to Intake Manifold).

Wrench, open-end, $\frac{7}{8}$ -in.

Disconnect flared tube nuts at check valve intake fitting and at intake manifold fitting, and remove pipe assembly.

(1) DISCONNECT FUEL FEED LINE AND WINDSHIELD WIPER PIPE ASSEMBLY AT FUEL PUMP.

Wrench, open-end, $\frac{3}{8}$ -in.Wrench, open-end, $\frac{1}{2}$ -in.

Disconnect main fuel line fitting at fuel pump inlet fitting. Then disconnect inverted flared tube nut that holds windshield wiper pipe assembly to vacuum side of fuel pump (fig. 125).

ENGINE (HERCULES GASOLINE)

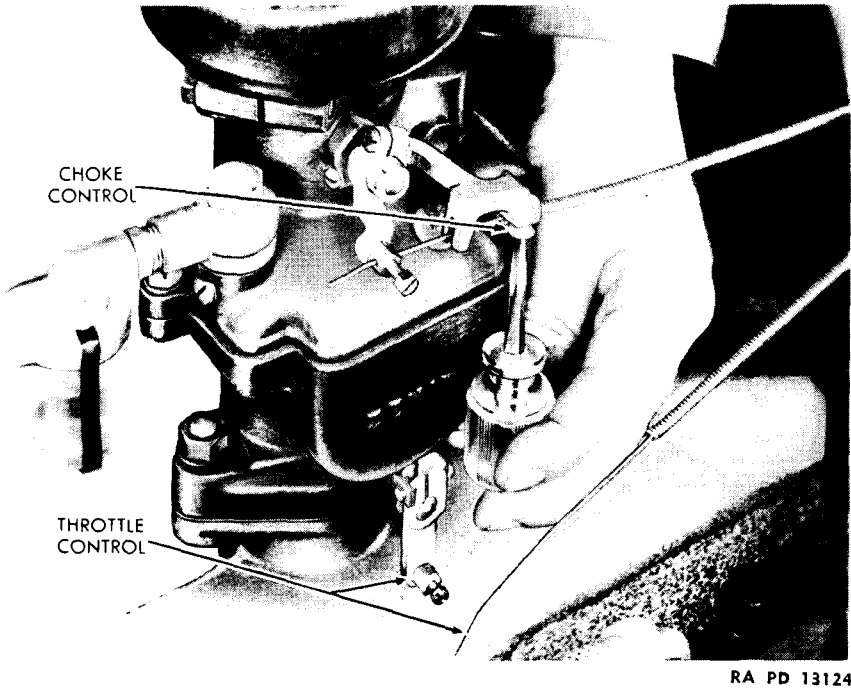

RA PD 13124

**Figure 124 — Disconnecting Control at Carburetor -
(Gasoline Engine)**

m. Remove Right-Hand Air Funnel Assembly.

Screwdriver

Wrench, open-end, $\frac{1}{16}$ -in.

Loosen clamp that holds funnel assembly to ventilator box. Remove cap screw and lock washer which hold funnel support bracket to frame, and lower funnel assembly.

n. Disconnect Exhaust Pipe at Manifold.

Wrench, open-end, $\frac{5}{8}$ -in.

Remove two brass nuts that hold exhaust pipe flange to manifold flange.

o. Disconnect Cable from Starting Motor.

Wrench, open-end, $\frac{9}{16}$ -in.

Remove terminal nut and pull cable from terminal.

SCOUT CAR M3A1

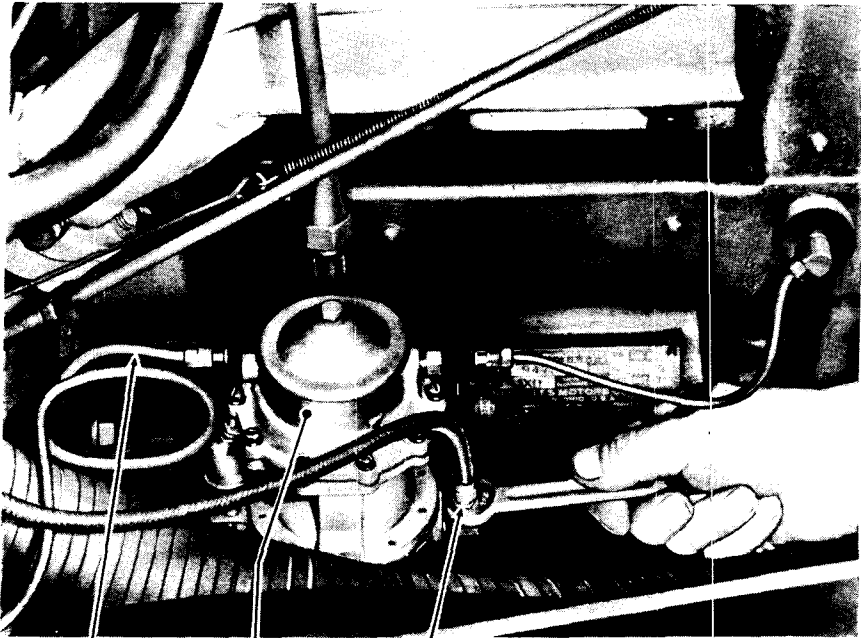
WINDSHIELD WIPER
PIPE ASSEMBLY

FUEL PUMP

MAIN FUEL
LINE FITTING

RA PD 13150

**Figure 125 — Removing Main Gas Line to Fuel Pump -
(Gasoline Engine)**

p. Disconnect High-Tension and Low-Tension Wires from Ignition Coil.

Screwdriver

Wrench, open-end, $\frac{3}{8}$ -in.

Remove two coil shielding cover screws and remove cover. Pull out high-tension wire from coil. Remove nut that holds low-tension wire to coil terminal and pull off wire.

q. Disconnect Manual Spark Control.

Screwdriver

Loosen screw that holds control wire to spark control arm and loosen clamp screws at bracket. Pull out spark control.

r. Disconnect Armature Conduit and Wire Assembly at Generator.

Pliers, channellock

Wrench, socket, $\frac{9}{16}$ -in.

Screwdriver, thin

Remove armature condenser from housing and screw off armature conduit nut from housing. Then remove armature terminal post nut,

ENGINE (HERCULES GASOLINE)

lift off cable terminal from armature terminal post and pull out conduit and wire assembly (figs. 74, 75 and 76).

s. Remove Generator Field Conduit and Wire Assembly at Generator.

Screwdriver	Wrench, socket, $\frac{3}{4}$ -in., thin-walled
Wrench, open-end, $\frac{3}{8}$ -in.	
Wrench, open-end, $\frac{5}{8}$ -in.	

Remove generator field terminal housing plug and screw off conduit nut from housing. Then remove field terminal post nut and pull out conduit and wire assembly. Loosen clamp that holds generator field and armature conduits to engine bracket, and free conduits (figs. 77, 78 and 79).

t. Disconnect Oil Filter and Pressure Gage Line Assemblies.

Wrench, open-end, $\frac{7}{16}$ -in.	Wrench, open-end, $\frac{1}{2}$ -in.
---------------------------------------	--------------------------------------

Disconnect oil filter inlet line assembly and oil pressure gage line assembly by unscrewing inverted flared tube nuts from fittings at rear left side of engine block. Break oil filter return line assembly at flared tube fitting located between rear of block and filter.

u. Remove Temperature Gage Bulb Assembly.

Wrench, open-end, $\frac{5}{8}$ -in.

Loosen temperature gage bulb adapter nut at rear left side of engine cylinder head and pull out bulb from adapter (fig. 116).

v. Remove Vacuum Line Assembly from Check Valve to Booster Hose.

Screwdriver	Wrench, open-end, $\frac{7}{8}$ -in.
Wrench, open-end, $\frac{3}{4}$ -in.	

Unscrew inverted flared tube nut at check valve. Remove cap screw and lock washer that hold line clip to rear of engine block. Loosen booster hose clamp screw and pull out line assembly.

w. Remove Left-Hand Air Funnel Assembly.

Screwdriver	Wrench, open-end, $\frac{7}{16}$ -in.
-------------	---------------------------------------

Loosen clamp that holds funnel assembly to ventilator box. Remove nut, cap screw and lock washer that hold funnel support clamp to bracket, and lower assembly.

x. Disconnect Brake Vacuum Booster and Bracket Assembly.

Wrench, socket, $\frac{9}{16}$ -in., with speed handle

Remove three cap screws and lock washers that hold booster bracket to engine crankcase, and lower bracket and booster assembly.

SCOUT CAR M3A1**y. Remove Floor Plate over Transmission.**

Screwdriver

Unscrew and remove the transfer case shift lever ball. Remove seven machine screws that hold center floor plate and remove the plate. **NOTE:** Cover is easily removed by first lifting front section over extended section of dash and then lifting rear section.

z. Disconnect Propeller Shaft.Wrench, open-end, $\frac{5}{8}$ -in. (two)

Remove four nuts, lock washers and bolts that hold propeller shaft to the companion flange on transmission, and separate propeller shaft from companion flange.

aa. Remove Clutch Release Bearing Outer Oil Tube.Wrench, open-end, $\frac{7}{16}$ -in.Wrench, socket, $\frac{9}{16}$ -in.

Unscrew inverted flared tube nut from elbow on bell housing. Remove cap screw and lock washer holding oil tube clip to bell housing and lift out oil tube.

bb. Remove Transfer Case Shift Lever.Wrench, socket, $\frac{9}{16}$ -in.

Remove two cap screws and lock washers securing transfer case shift lever to transmission and lift assembly out of the way.

cc. Remove Hand Brake Lever.

Screwdriver

Wrench, socket, $\frac{9}{16}$ -in.

Release hand brake and remove the two nuts and lock washers that secure the hand brake lever assembly to transmission. Pry hand brake lever assembly away from studs on transmission (screwdriver) and allow it to drop down out of the way.

dd. Remove Transmission Shift Lever.Wrench, socket, $\frac{9}{16}$ -in.

Remove four cap screws and lock washers and lift off shift lever and top assembly. Cover opening to prevent dirt from entering transmission.

ee. Remove Clutch Release Pedal Shaft Lever.

Hammer

Wrench, open-end, $\frac{9}{16}$ -in. (two)

Pliers

Remove cotter pin and pull out clevis pin at clutch release pedal shaft lever. Loosen nut on cap screw clamping lever to shaft and drive off lever. Remove lubricating fitting from shaft support to prevent it from breaking off when removing engine.

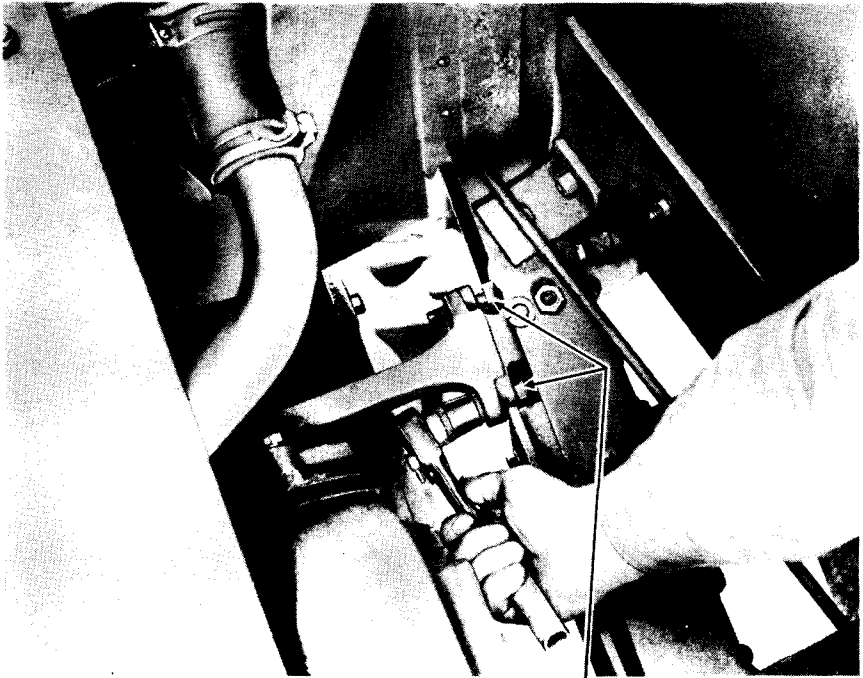
ENGINE (HERCULES GASOLINE)

FRONT ENGINE SUPPORT BOLTS

RA PD 13085

Figure 126 — Removing Front Engine Support Bolts**ff. Prepare Engine for Removal.**

Hoist

Rope, Manila, $\frac{3}{4}$ -in. (at least
14 ft.)

Tie rope around engine in a figure eight. Place hoist hook in balanced place of rope (slightly to rear of engine) and remove slack in rope by raising hook.

gg. Disconnect Engine Supports.

Handle, ratchet

Wrench, open-end, $\frac{1}{2}$ -in.

Pliers

Wrench, socket, $\frac{3}{4}$ -in.Wrench, open-end, $\frac{3}{4}$ -in.Wrench, socket, $\frac{1}{2}$ -in.

Remove cotter pins from castellated nuts at rear support bolts and remove the nuts, bolts, washers and right support spring. Remove four nuts, lock washers and cap screws from the front engine supports (fig. 126).

hh. Remove Engine Assembly. Lift engine until free of supports and move straight forward until transmission is clear of dash. **NOTE:** Use care in guiding engine out, to prevent clutch lever shaft from catch-

SCOUT CAR M3A1

ing on engine support brackets. Lift engine, with transmission, out of vehicle and place in stand or on blocks.

145. ENGINE INSTALLATION.

Crank	Wrench, open-end, $\frac{7}{16}$ -in.
Handle, ratchet	Wrench, open-end, $\frac{1}{2}$ -in.
Handle, speed	Wrench, open-end, $\frac{9}{16}$ -in. (two)
Hoist	Wrench, open-end, $\frac{5}{8}$ -in.
Pail, large, (or water hose)	Wrench, open-end, $\frac{3}{4}$ -in.
Pliers, channellock	Wrench, open-end, $\frac{7}{8}$ -in.
Rope, Manila, $\frac{3}{4}$ -in.	Wrench, open-end, $1\frac{5}{8}$ -in.
Screwdriver	Wrench, socket, $\frac{9}{16}$ -in.
Screwdriver, heavy-duty	Wrench, socket, $\frac{3}{4}$ -in.
Screwdriver, heavy-duty square shank	Wrench, socket, $1\frac{5}{8}$ -in.
Wrench, box, $\frac{9}{16}$ -in.	Wrench, socket, $\frac{3}{8}$ -in., thin-walled
Wrench, open-end, $\frac{3}{8}$ -in.	Wrench, socket, $\frac{7}{8}$ -in., with universal attachment

a. Place Engine Assembly in Vehicle.

Hoist

Rope, Manila, $\frac{3}{4}$ -in.

With transmission mounted on engine, place rope around the assembly in a figure eight. Place hoist hook in balanced position on rope and raise engine assembly high enough to clear front frame cross member. Carefully guide engine assembly into position on rear engine support brackets. NOTE: Place pads on support brackets before engine is finally positioned.

b. Bolt Engine Assembly to Frame.

Handle, ratchet

Wrench, open-end, $1\frac{5}{8}$ -in.

Pliers

Wrench, socket, $\frac{3}{4}$ -in.

Wrench, open-end, $\frac{3}{4}$ -in.

Wrench, socket, $1\frac{5}{8}$ -in.

Secure rear engine supports with plain washers, bolt and castle nut on left side and plain washers, bolt, spring and castle nut on right side. Install cotter pins in castle nuts and lock pins. Bolt front trunnion to frame with four cap screws, lock washers and nuts.

c. Install Transmission Shift Lever Assembly.

Wrench, socket, $\frac{9}{16}$ -in.

Place lever and cover assembly over transmission cover, guiding lever into position on lugs in transmission cover. Secure lever and cover assembly with four cap screws and lock washers.

d. Install Clutch Release Bearing Outer Oil Tube.

Wrench, open-end, $\frac{7}{8}$ -in.

Wrench, socket, $\frac{9}{16}$ -in.

ENGINE (HERCULES GASOLINE)

Place oil tube in position and screw inverted flared tube nut into elbow on bell housing. Secure tube clip to bell housing with cap screw and lock washer.

e. Install Transfer Case Shift Lever.

Wrench, socket, $\frac{9}{16}$ -in.

Mount transfer case shift lever assembly on transmission cover and secure with two cap screws and lock washers.

f. Install Hand Brake Lever.

Wrench, socket, $\frac{9}{16}$ -in.

Slip hand brake lever assembly over studs on transmission and secure with two nuts and lock washers.

g. Connect Propeller Shaft.

Wrench, open-end, $\frac{5}{8}$ -in. (two)

Connect propeller shaft to transmission companion flange with four cap screws, lock washers and nuts.

h. Install Clutch Release Shaft Lever.

Hammer

Wrench, open-end, $\frac{9}{16}$ -in. (two)

Pliers

With Woodruff key in position on shaft, replace lever and secure with cap screw, nut and lock washer. Connect clevis to lever with clevis pin, and lock clevis pin with cotter pin. Check for proper travel of clutch pedal (par. 72).

i. Replace Floor Plate over Transmission.

Screwdriver

Place floor plate in position over transmission and secure with seven machine screws.

j. Connect Brake Vacuum Booster and Bracket Assembly.

Handle, speed

Wrench, socket, $\frac{9}{16}$ -in.

Raise booster and bracket assembly into position and bolt to crank-case with lock washers and cap screws.

k. Install Vacuum Line Assembly from Check Valve to Booster Hose.

Screwdriver

Wrench, open-end, $\frac{7}{8}$ -in.

Wrench, open-end, $\frac{3}{4}$ -in.

Insert line into booster hose and fasten by tightening hose clamp screw. Secure hose clip to engine block with lock washer and cap screw. Attach upper end of line to check valve with inverted flared tube nut.

SCOUT CAR M3A1**l. Install Temperature Gage Bulb Assembly.**

Wrench, open-end, $\frac{5}{8}$ -in.

Insert bulb into adapter at rear left side of engine cylinder head and secure by tightening adapter nut (fig. 116).

m. Connect Oil Filter and Pressure Gage Line Assemblies.

Wrench, open-end, $\frac{7}{16}$ -in.

Wrench, open-end, $\frac{1}{2}$ -in.

Connect oil filter inlet line assembly and oil pressure gage line assembly to fittings in left rear side of engine block by means of their inverted flared tube nuts. Connect oil filter return line assembly between rear of engine block and filter.

n. Connect Generator Field Conduit and Wire Assembly at Generator.

Screwdriver

Wrench, socket, thin wall, $\frac{3}{8}$ -in.

Wrench, open-end, $\frac{5}{8}$ -in.

Slide wire through shielding housing; place it on field post, and secure with nut. Fasten conduit to housing with conduit nut. Install field terminal housing plug (figs. 77, 78 and 79). Clamp field and armature conduits to engine bracket.

o. Connect Armature Conduit and Wire Assembly at Generator.

Pliers, channellock

Wrench, socket, $\frac{9}{16}$ -in.

Slide wire through shielding housing; place it on armature post, and secure with nut. Fasten conduit to housing with conduit nut. Install condenser in housing (figs. 74, 75 and 76).

p. Connect Manual Spark Control at Distributor.

Screwdriver

Insert wire through nut at spark control arm and tighten holding screw. Fasten spark control, holding clip to bracket with screw.

q. Connect High-Tension and Low-Tension Wires at Ignition Coil.

Screwdriver

Wrench, open-end, $\frac{3}{8}$ -in.

Place low-tension wire on coil terminal and secure with nut. Insert high-tension wire into coil opening. Install coil shielding cover and secure with screws (fig. 86).

r. Connect Cable to Starting Motor.

Wrench, open-end, $\frac{9}{16}$ -in.

Place cable on starting motor terminal and secure with terminal nut.

s. Connect Exhaust Pipe to Manifold.

Wrench, open-end, $\frac{5}{8}$ -in.

Place a new gasket between exhaust and manifold flanges and secure flanges with brass nuts.

ENGINE (HERCULES GASOLINE)

t. Connect Fuel Feed Line and Windshield Wiper Pipe Assembly to Fuel and Vacuum Pump.

Wrench, open-end, $\frac{3}{8}$ -in.

Wrench, open-end, $\frac{1}{2}$ -in.

Connect fuel feed line to inlet fitting of fuel pump, and connect windshield wiper pipe assembly to vacuum side of fuel pump with inverted flared tube nut (fig. 125).

u. Connect Pipe Assembly (Check Valve to Intake Manifold).

Wrench, open-end, $\frac{7}{8}$ -in.

Install the vacuum line from intake manifold to check valve and secure with flared tube nuts.

v. Connect Carburetor Controls.

Screwdriver

Wrench, open-end, $\frac{7}{16}$ -in.

Insert choke and throttle controls into their respective control levers, and clamp them by tightening clamp screws (fig. 124). Insert throttle foot control rod into throttle lever, and secure with lock washer and nut.

w. Install Carburetor Air Horn and Rubber Hose Assembly.

Screwdriver

Wrench, open-end, $\frac{1}{2}$ -in.

Force hose onto air cleaner outlet and place air horn over carburetor air inlet. Tighten hose clamp at air filter, and air horn clamp at carburetor (fig. 123).

x. Connect Heater Inlet and Return Hoses to Engine Outlets.

Screwdriver

Force hoses onto water pump and cylinder head heater connections and secure with clamps. Then clamp hoses to cylinder head hose brackets.

y. Install Left-Hand Air Funnel Assembly.

Screwdriver

Wrench, open-end, $\frac{7}{16}$ -in.

Place funnel assembly over ventilator box inlet and secure with clamp screw. Bolt funnel support clamp to bracket with cap screw, lock washer and nut.

z. Install Right-Hand Air Funnel Assembly.

Screwdriver

Wrench, open-end, $\frac{9}{16}$ -in.

Place funnel assembly over ventilator box inlet and secure with clamp screw. Attach funnel support bracket to frame with lock washer and cap screw.

aa. Install Radiator Assembly.

Hoist, chain

Wrench, socket, $\frac{7}{8}$ -in., with
universal attachment

Wrench, socket, $\frac{3}{4}$ -in.

SCOUT CAR M3A1

Set radiator in position on pads, so that mounting studs pass through holes in pads and frame member. Connect stay rods at frame with stay rod stud nuts (fig. 48). Place springs and washers on mounting studs and secure with nuts and cotter pins.

bb. Install Radiator Hose Assemblies.

Screwdriver

Install pipe and hose assemblies between cylinder head and radiator inlet connections and secure hose clamps. Then install pipe and hose assemblies between radiator outlet and water pump inlet connections, and secure hose clamps.

cc. Install Shutter Assembly.

Hoist, chain

Wrench, box, $\frac{9}{16}$ -in.

Screwdriver, heavy-duty

Wrench, open-end, $\frac{1}{2}$ -in.

Place shutter assembly in position with hoist. Secure shutter side plates to body side plates by installing holding screws and nuts. Connect shutter control at lower right side of radiator.

dd. Install Hood Assembly.

Hoist

Screwdriver, heavy-duty

Rope, length of

square shank

Wrench, open-end, $\frac{9}{16}$ -in.

Place hood assembly and top shutter louver in position on cowl and shutter assembly. Install bolts and elastic stop nuts, securing rear of hood to cowl and front of hood to shutter assembly. Remove rope from shutter.

ee. Connect Battery.

Wrench, open-end, $\frac{9}{16}$ -in.

Place cable terminals on battery terminals and secure clamp nuts (fig. 68). Be sure all terminals are clean and that cable terminals are placed on correct battery terminals. Install battery compartment cover.

ff. Prepare Vehicle for Road.

Pail (or water hose), large

Fill cooling system with liquid. Check oil level in crankcase. Start engine and check oil pressure. Check cooling system and lubricating system for leaks.

Section XXII

ENGINE (HERCULES DIESEL)

	Paragraph
General description	146
Characteristics	147
Trouble shooting	148
Cylinder head removal	149
Cylinder head installation	150
Flywheel marking	151
Removal and installation of manifold	152
Removal and installation of oil pan	153
Oil pump	154
Valve mechanism	155
Cleaning carbon	156
Vacuum pump	157
Engine vacuum pump oil separating tank	158
Oil filter	159
Engine removal	160
Engine installation	161

146. GENERAL DESCRIPTION.

The Hercules Diesel engine is a six-cylinder, compression-ignition type of engine. It has overhead valves and operates on the four-stroke principle. The cylinders and crankcase are cast in a single block. The cylinder head is detachable and contains the valves and rocker arm assemblies.

147. CHARACTERISTICS.

Model	Hercules DJXD
Cylinders	6
Bore	4-in.
Stroke	4½-in.
Displacement (cubic inches)	339
Compression ratio	14.5 to 1
Automotive Manufacturers' Association horsepower	38.4
Brake horsepower at 2,600 rpm	103
Maximum torque at 1,600 rpm (foot-pounds)	233
Crankcase capacity, including oil filter (quarts)	9½
Weight (including accessories)	3,380 lb.

SCOUT CAR M3A1

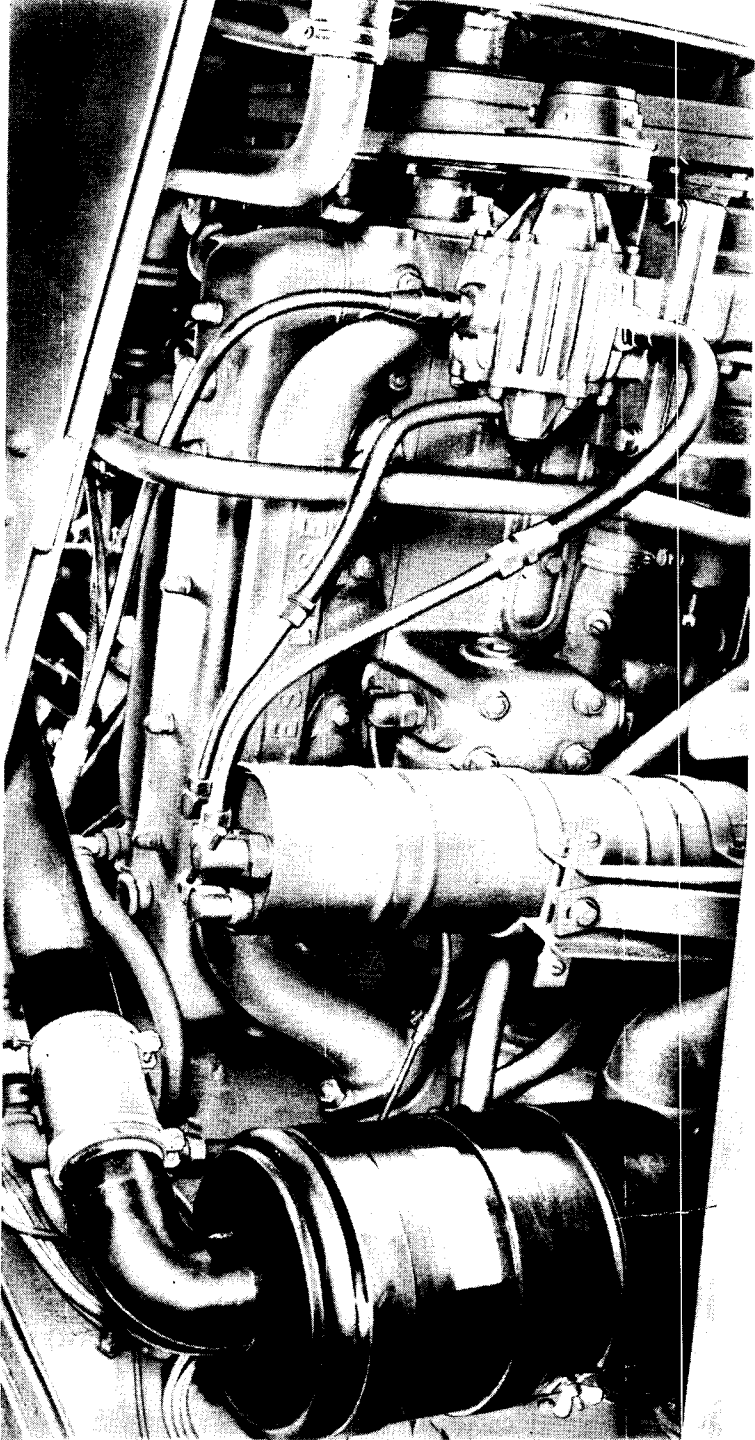

RA PD 13151

Figure 127 — Hercules Diesel Engine - Installed -Right Side

ENGINE (HERCULES DIESEL)

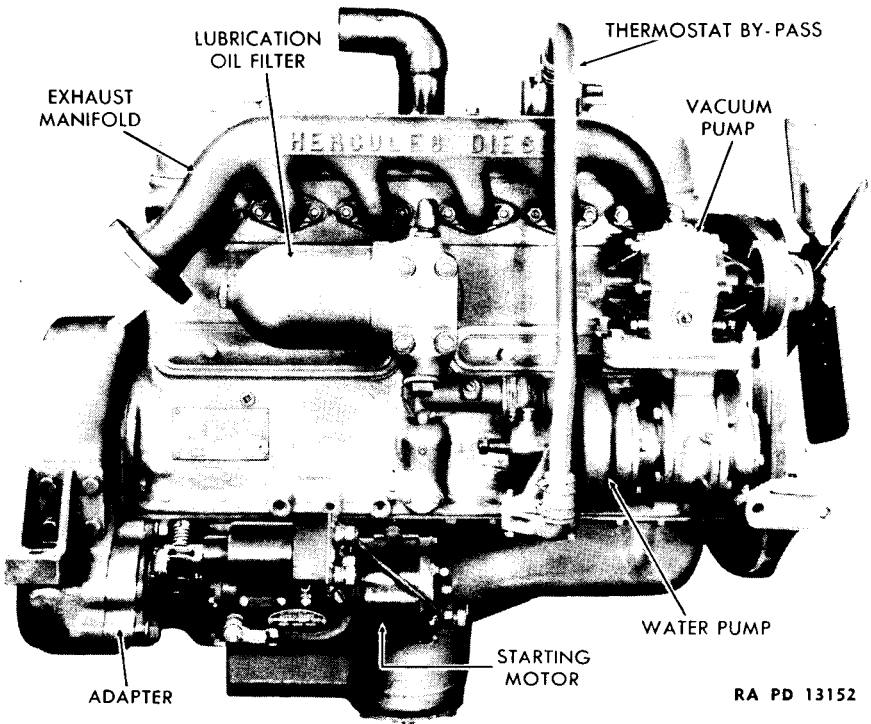

RA PD 13152

Figure 128 — Right Side View of Hercules Diesel Engine

148. TROUBLE SHOOTING.

a. Engine Won't Start or Hard Starting

Symptom and Probable Cause	Probable Remedy
No fuel in tank.	Fill tank.
No fuel in fuel pump.	See section XXVII.
Not properly prepared for starting at the atmospheric temperature being encountered.	See section II.
Weak batteries will not turn the engine over rapidly enough.	Recharge batteries.
Fuel too heavy to flow through pipes properly.	Use fuel specified.
Water in fuel.	Drain fuel system and tanks.
Leaking head gasket.	Replace gasket.
Air cleaner plugged, not allowing sufficient air to pass through.	Clean air cleaner.
Governor stop lever stuck in shut-off or stop position.	Refer to ordnance maintenance personnel.

SCOUT CAR M3A1

h. Engine Stops Suddenly.

Symptom and Probable Cause

- No fuel.
- Fuel pumps or lines air or gas bound.
- Fuel filter plugged.
- Obstruction in, or broken fuel lines.
- Water in fuel.

Probable Remedy

- Fill tank, prime, and start. See section XXVII.
- Clean filter, then prime lines.
- Check, starting with fuel tank to strainer.
- Drain entire system including tank and clean. Fill with clean fuel. Then proceed as in section II.
- Replace with new chain and

Broken fuel pump driving chain

Replace with new chain and

retime engine. See section XXVII.

Fuel pump adjustable coupling slipped due to not being properly tightened.

Retime pump, See section XXVII.

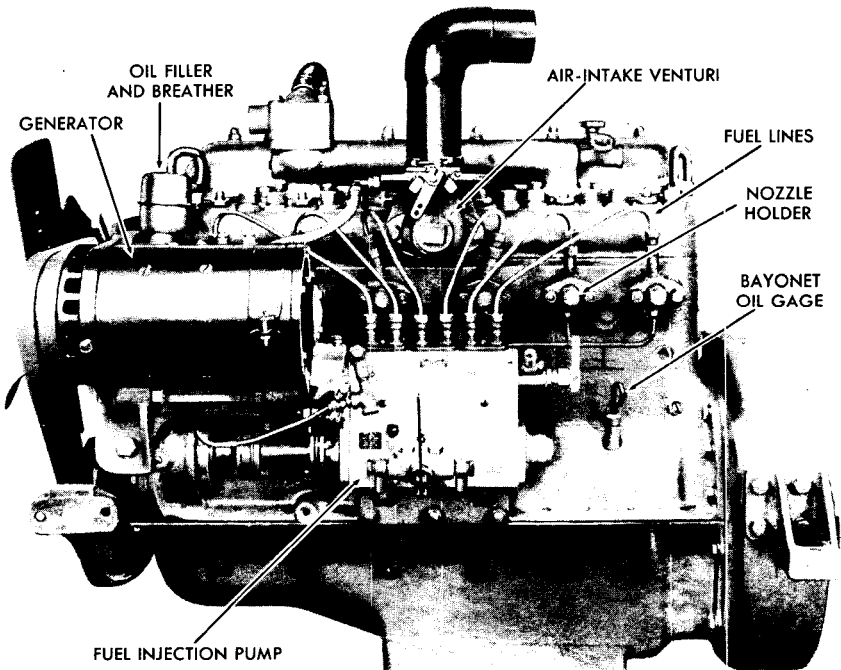

ENGINE (HERCULES DIESEL)

c. Engine Missing Erratically or Intermittently on All Cylinders.

Symptom and Probable Cause

Probable Remedy

Improper fuel.

Drain system, including tank, and refill with clean fuel.

Water in fuel.

Drain system, including tank, of all water and sediment. Refill with clean fuel.

Plugged air cleaner, reducing air admitted to cylinders.

Clean air cleaner.

d. Engine Missing on One or Two Cylinders. To determine which cylinder or cylinders are missing, loosen the nuts connecting the fuel lines to the fuel nozzles, one at a time. If the engine speed remains the same and exhaust sounds the same, that means that the cylinder on which the fuel line is loosened is missing. If the engine speed slows down and the exhaust loses its rhythm, then the cylinder is functioning.

Fuel valve stuck in body.

Remove and clean, or install new injector.

Air or gas binding in fuel pump lines.

Usually, when testing to see what cylinder is missing this condition will be cleared up, as opening the nut allows the air or gas to escape.

Exhaust or intake valve stuck.

Remove valve cover and check to locate which one is stuck. Free with SOLVENT, dry cleaning, or alcohol poured down the stem. Alcohol is the quickest solvent. If still stuck, remove head and determine cause.

Exhaust or intake valve spring or spring retainer lock broken.

Replace with a new one.

Improper exhaust or intake valve clearance between valve and rocker arm.

Check clearance and reset to proper clearance.

e. Brown or Black Smoke in Exhaust Gases.

Leaky cylinder head gasket.

Remove and clean, or replace.

Leaky valves.

Regrind.

SCOUT CAR M3A1

Symptom and Probable Cause	Probable Remedy
Dirty spray nozzles.	Clean.
Improper fuel oil.	Use specified fuel oil.
Fuel injection timing too early, usually accompanied with fuel knocks or noisy engine.	Adjust timing of injection.
Fuel injection timing too late, accompanied with loss of power but smooth and quiet running engine.	Adjust timing of injection.
Fuel pump drive chain too loose.	Tighten and retime engine.

f. Fuel Knocks in One Cylinder Only.

Spray nozzle valve sticking from dirt or corrosion.	Clean valve with a cloth (not abrasives), and clean body with a piece of wood. Turn valve stem in body until free, then coat with clean engine oil and replace.
Spray nozzle spring broken.	Replace complete holder. Never attempt to change nozzle springs in the field, as they must be accurately calibrated with instruments.
Fuel delivery valve in pump stuck open from dirt or corrosion.	Clean valve stem with cloth and valve seat with small piece of wood. Do not use abrasives or metallic tools as they will spoil these delicate parts.
Broken delivery valve spring in fuel pump.	Replace.
Leaky cylinder head gasket.	Clean or replace.

g. Fuel Knocking in More Than One Cylinder and Erratic and Intermittent.

Sticking nozzle valve.	Dismantle and cleanse parts and also fuel strainers.
Water in fuel oil.	Drain fuel oil strainer sump and fuel tank of all water and sediment.

ENGINE (HERCULES DIESEL)

149. CYLINDER HEAD REMOVAL.

- | | |
|---------------------------------------|--|
| Bar, small | Wrench, open-end, $\frac{9}{16}$ -in. |
| Hammer, fiber | Wrench, open-end, $\frac{5}{8}$ -in. |
| Pail | Wrench, open-end, $\frac{3}{4}$ -in. |
| Pliers | Wrench, socket, $\frac{7}{8}$ -in., with
long handle |
| Screwdriver | Wrench, socket, $\frac{5}{8}$ -in., with
speed handle |
| Screwdriver, heavy-duty | |
| Wrench, open-end, $\frac{7}{16}$ -in. | |

a. Drain Radiator.

- | | |
|------|--------|
| Pail | Pliers |
|------|--------|

Open drain cocks at the bottom of the radiator and on engine block, and drain water into pail or on ground (save antifreeze if used).

b. Remove Hood.

- | | |
|-------------------------|---------------------------------------|
| Screwdriver, heavy-duty | Wrench, open-end, $\frac{9}{16}$ -in. |
|-------------------------|---------------------------------------|

Remove three elastic stop nuts and bolts at rear of center panel of hood. Remove nut and bolt from inside of shutter frame, near the top, on each side of frame. Lift off hood.

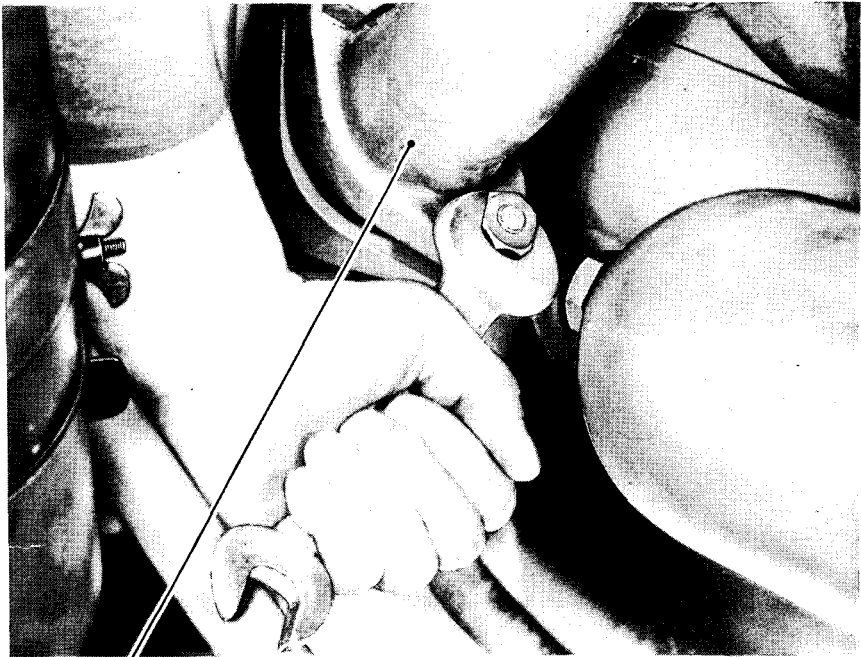

EXHAUST MANIFOLD

RA PD 13130

Figure 130 — Disconnecting Exhaust Pipe - (Hercules Diesel)

SCOUT CAR M3A1**c. Remove Radiator Hose Connection.**

Screwdriver.

Loosen hose clamps on upper radiator connection, and remove tube with hoses.

d. Remove Intake Hose and Tube.

Screwdriver

Loosen clamp on rubber hose at air cleaner, and clamp on elbow at Venturi. Lift up and remove air intake hose and tube.

e. Remove Heater Hose.

Screwdriver

Loosen hose clamp and slip off heater hose from shut-off cock at rear of heater outlet manifold.

f. Remove Thermostat Bypass.

Screwdriver

Loosen two hose clamps, one at top and one at bottom of bypass, and remove thermostat bypass.

g. Disconnect Vacuum Line to Dash.

Screwdriver

Wrench, open-end, $\frac{1}{8}$ -in.

Remove line and hose from vacuum pump to vacuum pump air cleaners. Unscrew vacuum pump air cleaner.

h. Disconnect Manifold at Exhaust Pipe.Wrench, open-end, $\frac{3}{4}$ -in.Wrench, open-end, $\frac{1}{8}$ -in.

Disconnect exhaust pipe flange from exhaust manifold flange (fig. 130).

i. Disconnect Generator Cables.

Screwdriver

Loosen screw on clamp fastening generator cables to thermostat housing, and pull cables out of the way.

j. Disconnect Venturi Controls.

Screwdriver

Wrench, open-end, $\frac{7}{16}$ -in.

Disconnect the hand-operated throttle wire and the foot-operated throttle rod from the Venturi.

k. Disconnect Venturi Heater Cable.Wrench, open-end, $\frac{7}{16}$ -in.

Unscrew nut securing cable to Venturi and remove cable.

l. Disconnect Heat Indicator Unit.Wrench, open-end, $\frac{5}{8}$ -in.

ENGINE (HERCULES DIESEL)

Loosen temperature gage bulb adapter nut at rear of water outlet manifold and pull out bulb from adapter.

m. Disconnect Venturi Vacuum Line.

Wrench, open-end, $\frac{9}{16}$ -in.

Disconnect vacuum line from Venturi to fuel injection pump governor at elbow on Venturi.

n. Remove Cylinder Head Cover.

Wrench, open-end, $\frac{5}{8}$ -in.

Remove the six acorn cylinder head cover nuts, plain washers and copper gaskets. Lift off cylinder head cover and gasket. Knobs on cover provide for easy removal (figs. 131 and 136).

o. Remove Water Outlet Manifold.

Wrench, open-end, $\frac{9}{16}$ -in.

Remove four cap screws and lock washers from the two mounting flanges and remove water outlet manifold and thermostat housing as a unit.

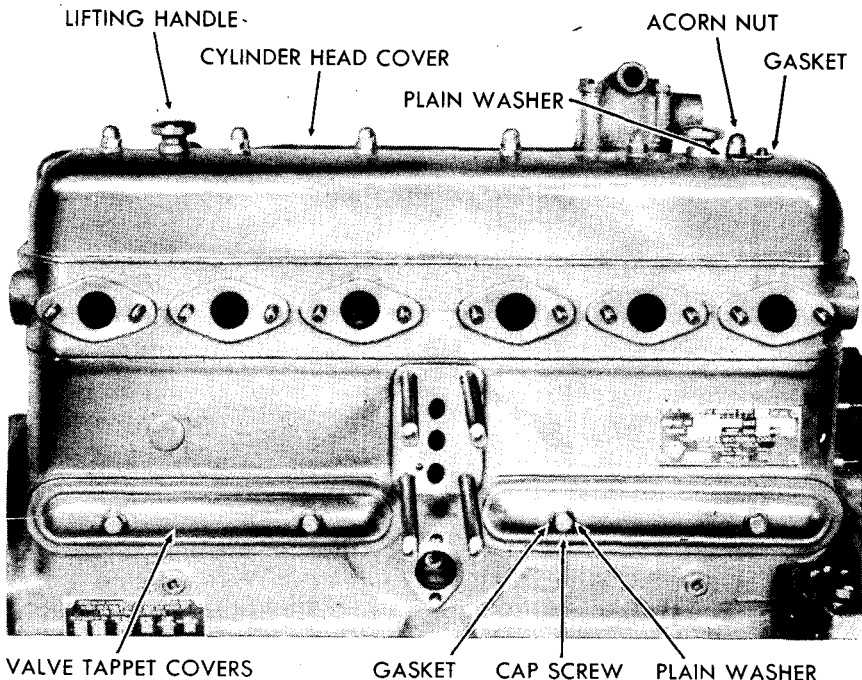

RA PD 13155

Figure 131 — Removing Cylinder Head Cover - (Hercules Diesel)

SCOUT CAR M3A1

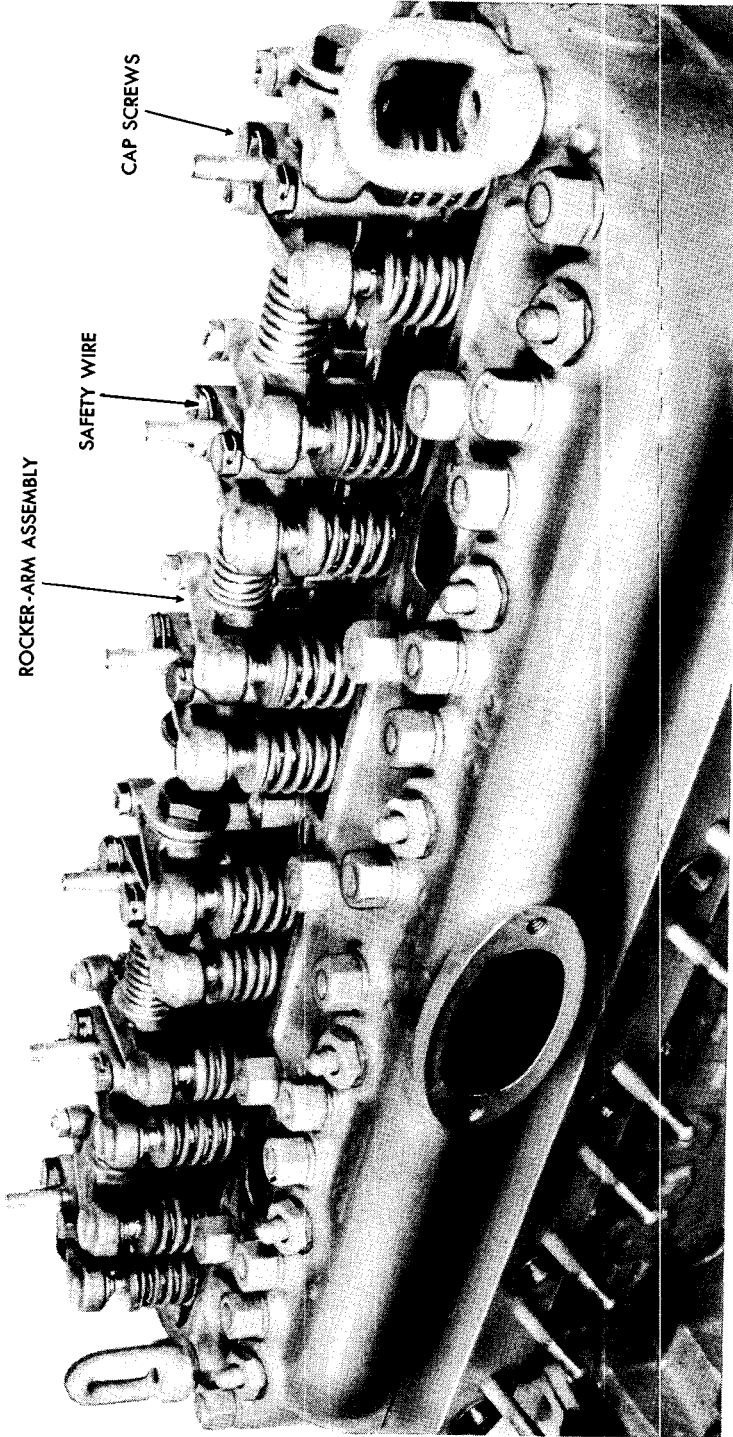

RA PD 13156

Figure 132 — Removing Rocker Arm Assemblies - (Hercules Diesel)

ENGINE (HERCULES DIESEL)

p. Remove Rocker Arm Assemblies.

Pliers
Wrench, socket, $\frac{5}{8}$ -in., with speed handle

The rocker arms are mounted on the cylinder head in the two assemblies. Each assembly is supported by three brackets which are held in place by two safety-wired cap screws. Remove safety wire and remove cap screw. Lift off rocker arm assemblies (fig. 132).

q. Remove Oil Filler Pipe.

Hammer, fiber

Lift off breather cap and remove filler pipe by tapping with hammer.

r. Remove Cylinder Head.

Bar, small
Wrench, socket, $\frac{7}{8}$ -in., with long handle

Using a small bar, remove engine lifting eyes. Remove 37 cylinder head stud nuts and remove all the plain washers. With much care, lift head straight up over studs and push rods. Lift off solid copper cylinder head gasket (fig. 133).

150. CYLINDER HEAD INSTALLATION.

Bar, small	Wrench, open-end, $\frac{7}{16}$ -in.
Gage, feeler	Wrench, open-end, $\frac{9}{16}$ -in.
Hammer, fiber	Wrench, open-end, $\frac{5}{8}$ -in.
Pail	Wrench, open-end, $\frac{3}{4}$ -in.
Pliers	Wrench, socket, $\frac{5}{8}$ -in.
Screwdriver	Wrench, socket, $\frac{7}{8}$ -in.
Screwdriver, heavy-duty	Wrench, tension

a. Install Cylinder Head.

Bar, small
Wrench, socket, $\frac{7}{8}$ -in.

Clean cylinder head and cylinder block surface and place a new solid copper gasket in position on cylinder block. Lift cylinder head over block studs and push rods and carefully lower into position on cylinder, taking care not to damage push rods or studs. Place plain washers under each nut and tighten the 37 stud nuts. The stud nuts should be progressively tightened, working from the center of cylinder head towards the sides and ends. These nuts should be tightened to 157½ foot-pounds or 1,890 inch-pounds (fig. 134).

b. Install Oil Filler Pipe.

Hammer, fiber

Place oil filler pipe in position and make secure by tapping with hammer. Put on breather cap.

SCOUT CAR M3A1

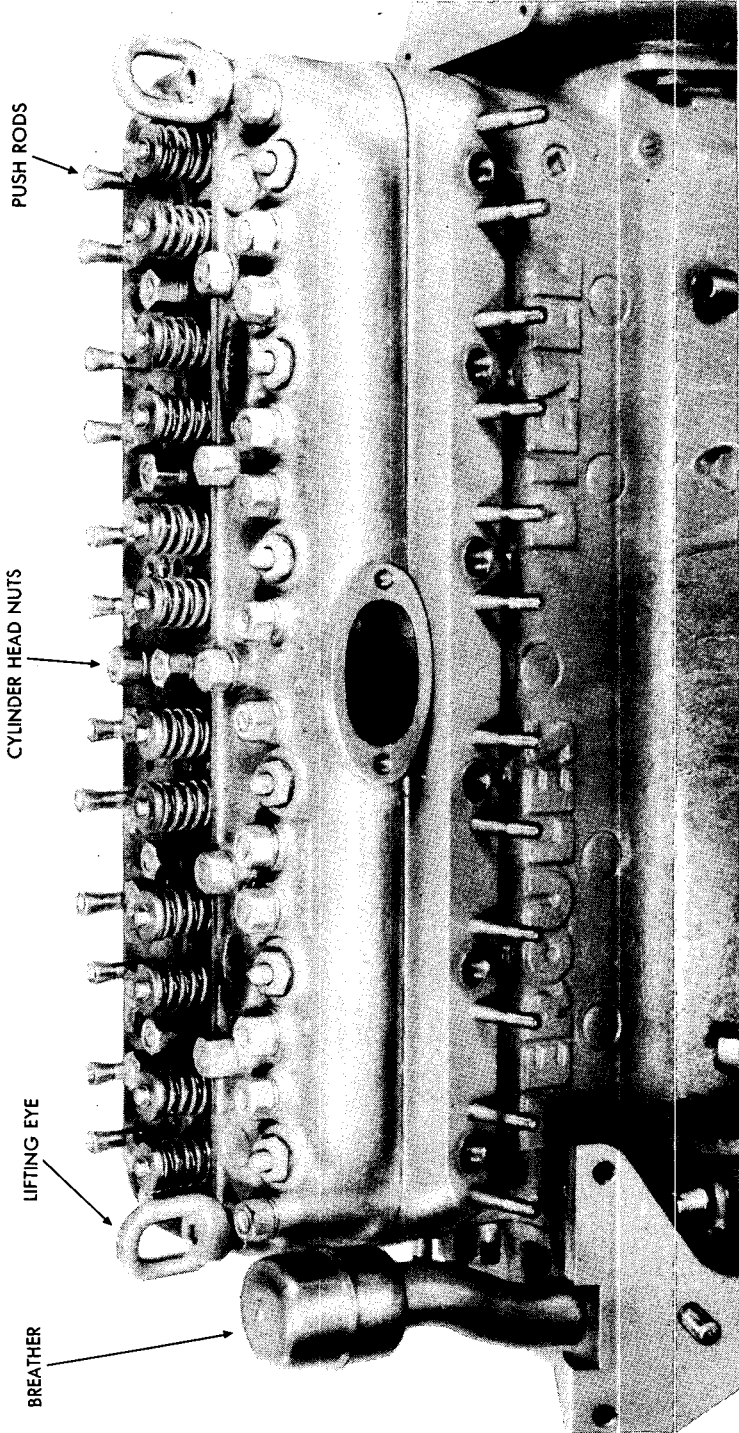

RA PD 13157

Figure 133 — Removing Cylinder Head - (Hercules Diesel)

ENGINE (HERCULES DIESEL)

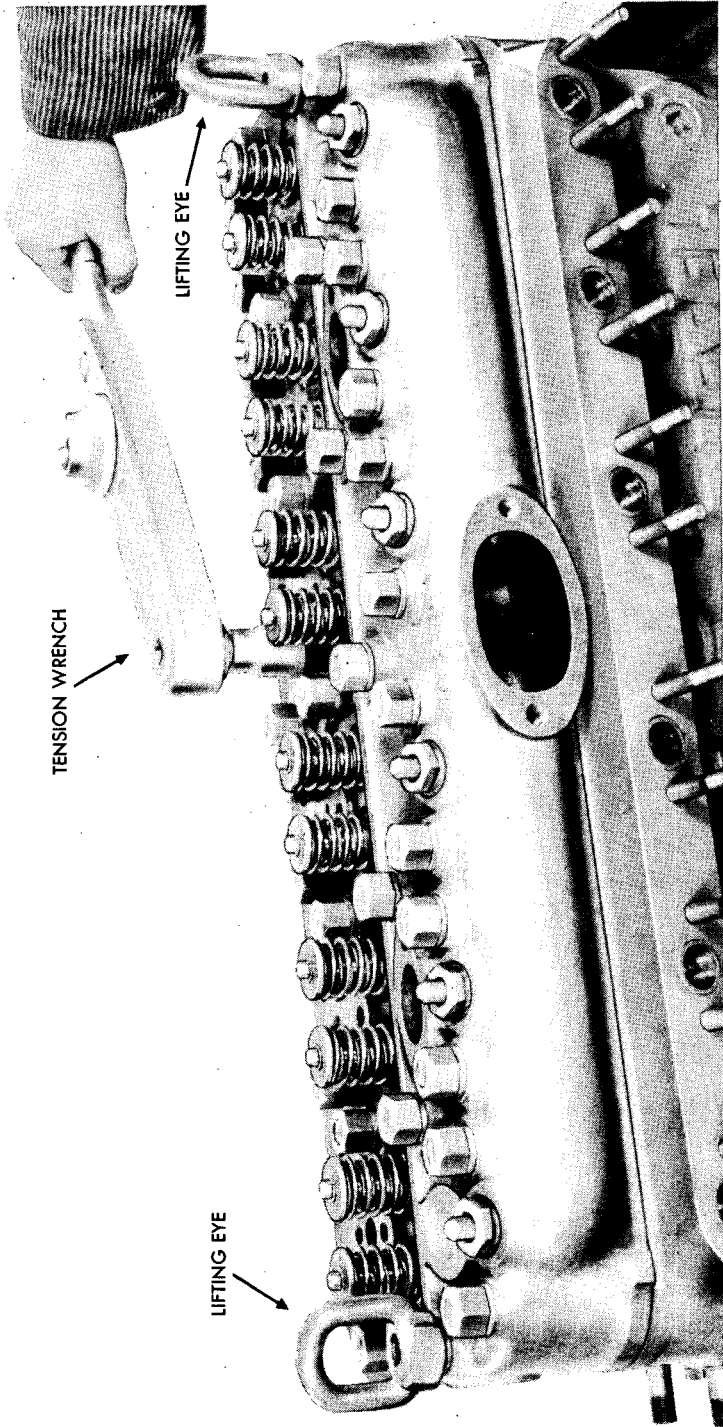

RA PD 13158

Figure 134 — Tightening Cylinder Head Nuts - (Hercules Diesel)

SCOUT CAR M3A1

c. Install Rocker Arm Assemblies.

Wrench, socket, $\frac{5}{8}$ -in.

Place the two rocker arm assemblies in position on the cylinder head. Be sure that the brackets having the base set screws are to the front of the engine. There are two recesses in the cylinder head for these set screws. Insert and tighten the 12 rocker arm bracket cap screws which secure the rocker arm assemblies to the cylinder head. Place safety wire through cap screw heads (fig. 132).

d. Adjust Valves.

Gage, feeler
Screwdriver

Wrench, open-end, $\frac{9}{16}$ -in.

Crank engine, so that the cylinder of which the valves are to be adjusted is in firing position. Place a 0.010-inch feeler gage between valve stem and rocker arm swivel (fig. 135). Loosen lock nut on rocker arm adjusting screw and turn adjusting screw until the feeler can be moved with a slight drag. Tighten lock nut. Proceed in this manner on all valves. NOTE: Valve clearances should be rechecked after engine has been thoroughly warmed up.

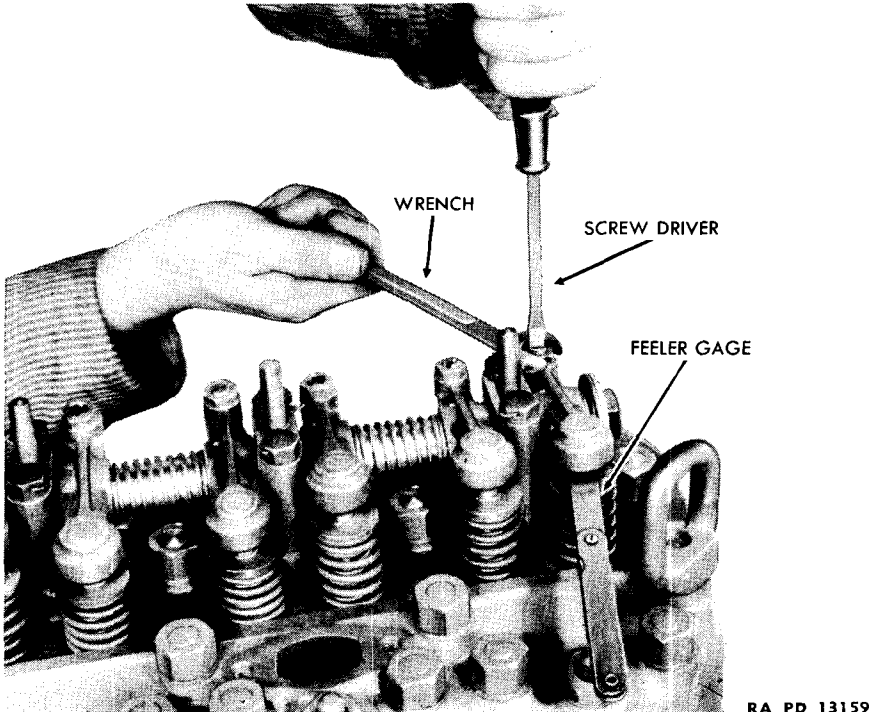

RA PD 13159

Figure 135 — Valve Adjustment - (Hercules Diesel)

ENGINE (HERCULES DIESEL)

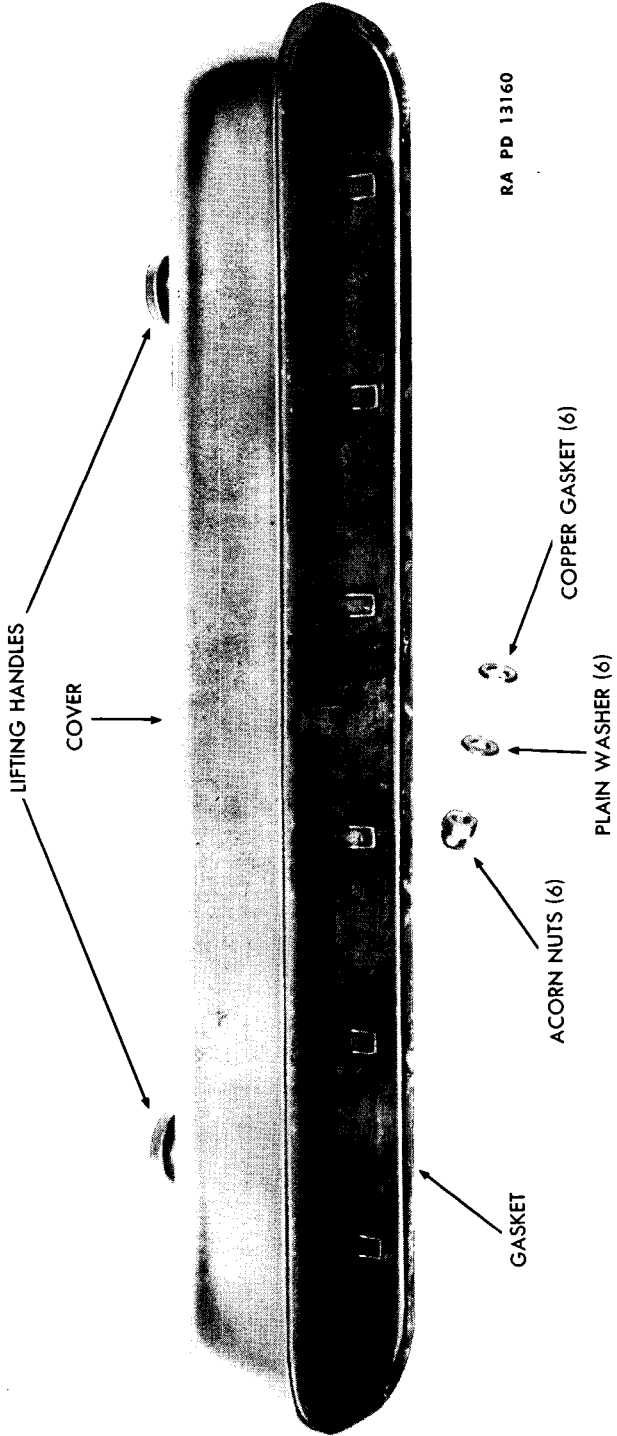

Figure 136 — Cylinder Head Cover - (Hercules Diesel)

SCOUT CAR M3A1**e. Install Water Outlet Manifold.**

Wrench, open-end, $\frac{9}{16}$ -in.

Place two new gaskets in position on cylinder head and secure water outlet manifold and thermostat housing with four cap screws and lock washers.

f. Install Cylinder Head Cover.

Wrench, open-end, $\frac{5}{8}$ -in.

Place cylinder head cover and gasket in position over studs on cylinder head. Place copper washer and plain washer on stud, and secure cover with acorn nuts (figs. 131 and 136).

g. Connect Heat Indicator Unit.

Wrench, open-end, $\frac{5}{8}$ -in.

Place temperature gage bulb into adapter on rear of water inlet manifold and secure with adapter nut.

h. Connect Vacuum Line at Venturi.

Wrench, open-end, $\frac{9}{16}$ -in.

Connect the flexible vacuum line from the fuel injection governor to the elbow fitting on the Venturi.

i. Connect Venturi Heater Cable.

Wrench, open-end, $\frac{7}{16}$ -in.

Place cable terminal over post in back of Venturi and secure with nut and lock washer.

j. Connect Venturi Controls.

Screwdriver

Wrench, open-end, $\frac{7}{16}$ -in.

Connect foot-operated throttle rod and hand-operated throttle wire to Venturi control lever.

k. Connect Generator Cables.

Screwdriver

Place generator cables in position on clamp secured to thermostat housing and tighten in position with screw.

l. Connect Manifold to Exhaust Pipe.

Wrench, open-end, $\frac{3}{4}$ -in.

Wrench, open-end, $\frac{7}{8}$ -in.

Place new gasket between exhaust pipe flange and exhaust manifold flange. Connect the two flanges.

m. Connect Vacuum Line to Dash.

Screwdriver

Wrench, open-end, $\frac{7}{8}$ -in.

Screw vacuum pump air cleaner in position on elbow fitting of check

ENGINE (HERCULES DIESEL)

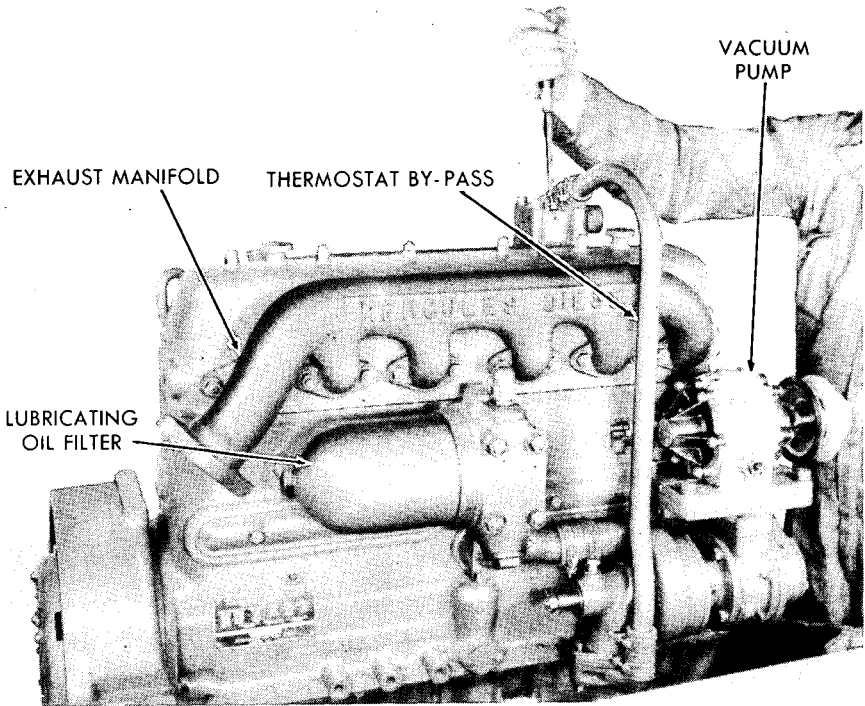

RA PD 13162

**Figure 137 — Attaching Thermostat Bypass to Engine -
(Hercules Diesel)**

valve mounted on dash. Connect vacuum hose to vacuum pump air cleaner, and vacuum line to vacuum pump.

n. Install Thermostat Bypass.

Screwdriver

Push the upper and lower hoses of the thermostat bypass in position on the thermostat housing and water pump connection and secure with hose clamps (fig. 137).

o. Connect Heater Hose.

Screwdriver

Push heater hose on shut-off cock fitting at rear of water outlet manifold and secure with hose clamp.

p. Install Intake Hose and Tube.

Screwdriver

Push hose over air cleaner outlet, and position elbow on Venturi. Secure assembly with clamps.

SCOUT CAR M3A1

q. Install Radiator Hose Connections.

Screwdriver

Place tube and hose in position on upper radiator connection and water outlet manifold. Secure hoses with hose clamps.

r. Fill Radiator.

Pail

Pliers

Shut off drain cock at bottom of radiator and fill radiator with water or suitable antifreeze solution.

s. Install Hood.

Screwdriver, heavy-duty

Wrench, open-end, $\frac{9}{16}$ -in.

Lift hood in position on engine compartment and secure the front section to shutter frame with nut, bolt and lock washer on each side, and the rear section with three elastic stop nuts and bolts.

151. FLYWHEEL MARKING.

The flywheel is marked "DC" indicating top dead center for No. 1 piston, and is visible through the flywheel timing hole which is located in the flywheel housing in front of the bell housing.

152. REMOVAL AND INSTALLATION OF MANIFOLD.

Wrench, open-end, $\frac{7}{8}$ -in.

Wrench, socket, $\frac{5}{8}$ -in., with speed handle

a. **Removal.** Use a $\frac{7}{8}$ -inch open-end wrench to loosen the manifold two nuts connecting the manifold to the exhaust pipes. Use a $\frac{5}{8}$ -inch socket wrench with speed handle for loosening and removing the other ten brass nuts from the manifold. Lift off the exhaust manifold and remove the six composition asbestos gaskets.

b. Installation.

Wrench, open-end, $\frac{7}{8}$ -in.

Wrench, socket, $\frac{5}{8}$ -in., with speed handle

Place six new asbestos gaskets on the exhaust manifold studs and slide the manifold in place. Secure the manifold to the engine with plain washers and brass nuts. Connect the manifold to the exhaust pipe with the two plain washers and brass nuts, using the $\frac{7}{8}$ -in. open-end wrench.

153. REMOVAL AND INSTALLATION OF OIL PAN.

Wrench, open-end, $\frac{3}{4}$ -in.

Wrench, socket, $\frac{9}{16}$ -in., with speed handle

a. **Removal.** Drain oil, remove the five cap screws and lock washers which secure the oil pan to the flywheel housing, using a $\frac{3}{4}$ -inch open-

ENGINE (HERCULES DIESEL)

end wrench. Remove the 28 cap screws and lock washers which hold the pan in position on the crankcase, using a $\frac{1}{16}$ -inch socket wrench with speed handle. Remove the oil pan with the gasket that is shellacked to it.

b. Installation.

Gage, feeler

Wrench, socket, $\frac{1}{16}$ -in., with
speed handle

Wrench, open-end, $\frac{3}{4}$ -in.

Shellac a new gasket to the mounting flange of the oil pan. Place the oil pan in position on the crankcase and up against the face of the bell housing. Insert the five cap screws, fitted with lock washers, in the pan and bell housing. Tighten with a $\frac{3}{4}$ -inch open-end wrench. Install the 28 cap screws, fitted with lock washers, in the pan and crankcase. Tighten these with a $\frac{1}{16}$ -inch socket wrench, fitted with a speed handle.

154. OIL PUMP.

a. **Description.** The oil pump is attached to the cylinder block, and is gear-driven by the camshaft. The lower end of the oil pump extends

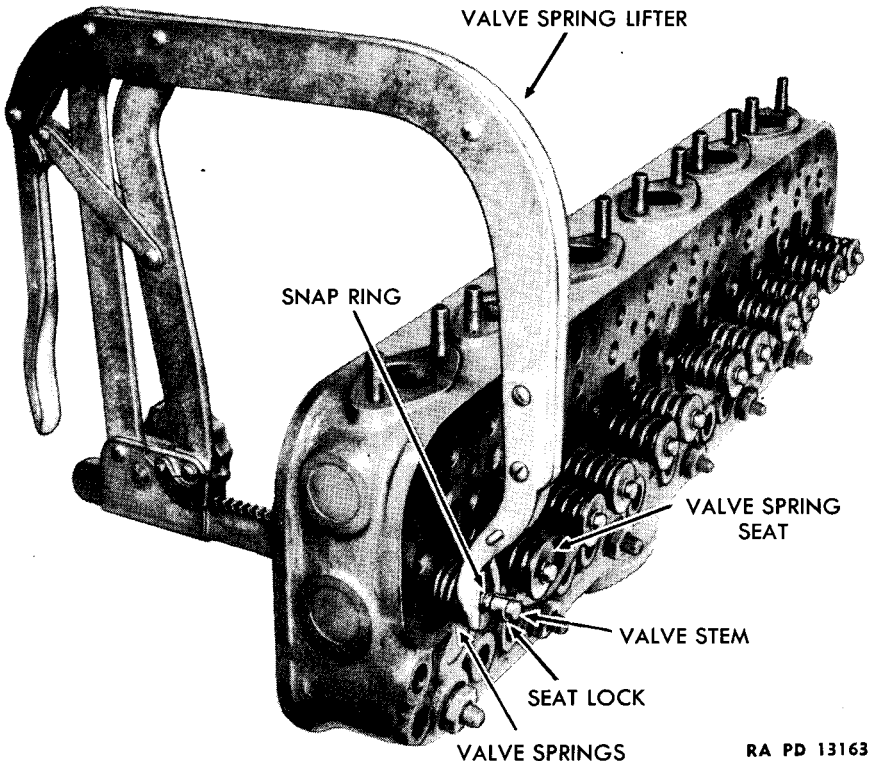

RA PD 13163

Figure 138 — Removing Valve - (Hercules Diesel)

SCOUT CAR M3A1

down in the oil pan, and oil is drawn into the pump through a large screen which prevents coarse dirt from being drawn into the lubricating pump. This strainer works in conjunction with the regular lubricating oil filter to remove foreign particles from the lubricating oil.

b. Removal.

Wrench, box, $\frac{9}{16}$ -in.

Wrench, open-end, $\frac{7}{8}$ -in.

Wrench, open-end, $\frac{3}{4}$ -in.

Drain the oil and remove the oil pan (par. 153). Use a $\frac{7}{8}$ -inch open-end wrench to loosen the union nut on the discharge tube coupling. Disconnect the discharge tube at both ends by loosening the nuts with a $\frac{3}{4}$ -inch open-end wrench. Remove the four cap screws and lock washers from the oil pump mounting flange, using a $\frac{9}{16}$ -inch box wrench. Rotate the pump $\frac{1}{2}$ turn to the right and lift it out.

c. Installation.

Wrench, box, $\frac{9}{16}$ -in.

Wrench, open-end, $\frac{7}{8}$ -in.

Wrench, open-end, $\frac{3}{4}$ -in.

Using a $\frac{9}{16}$ -inch box wrench, install the four lock washers and cap

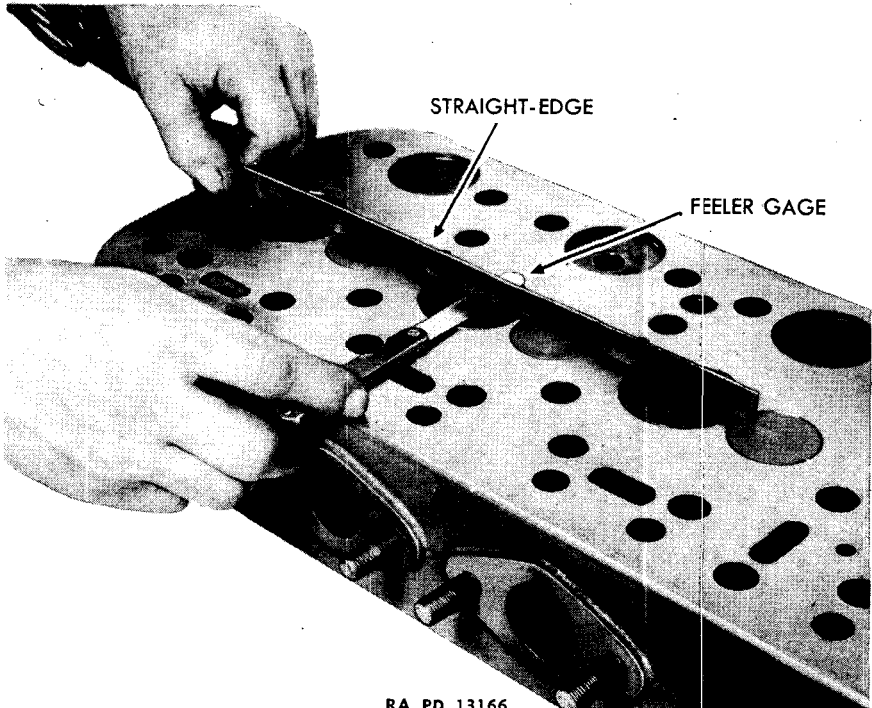

RA PD 13166

Figure 139 — Measuring Valve Head Clearance - (Hercules Diesel)

ENGINE (HERCULES DIESEL)

screws that secure the oil pump assembly to the under side of the crankcase on the center bearing web. Be sure the pump drive gear meshes properly with the gear on the camshaft. Connect the flexible line to the crankcase web and to the oil pump ($\frac{7}{8}$ -in. and $\frac{3}{4}$ -in. open-end wrenches). Install the oil pan (par. 153).

155. VALVE MECHANISM.

a. **Description.** The valves, located in the cylinder head, are operated by conventional type tappets with hollow push rods running from the tappets to the rocker arm. The rocker arms are lubricated by means of oil forced through the hollow shaft on which they rotate. The oil is forced through small holes in the rocker arms to the special ball cup over the valve stems. The valves are of the poppet type and have a 45-degree angle seat.

b. Valve Removal (fig. 138).

Bar

Hammer

Rack, valve

Screwdriver

Tool, valve spring lifting

(1) REMOVE THE CYLINDER HEAD ASSEMBLY. Refer to paragraph 150.

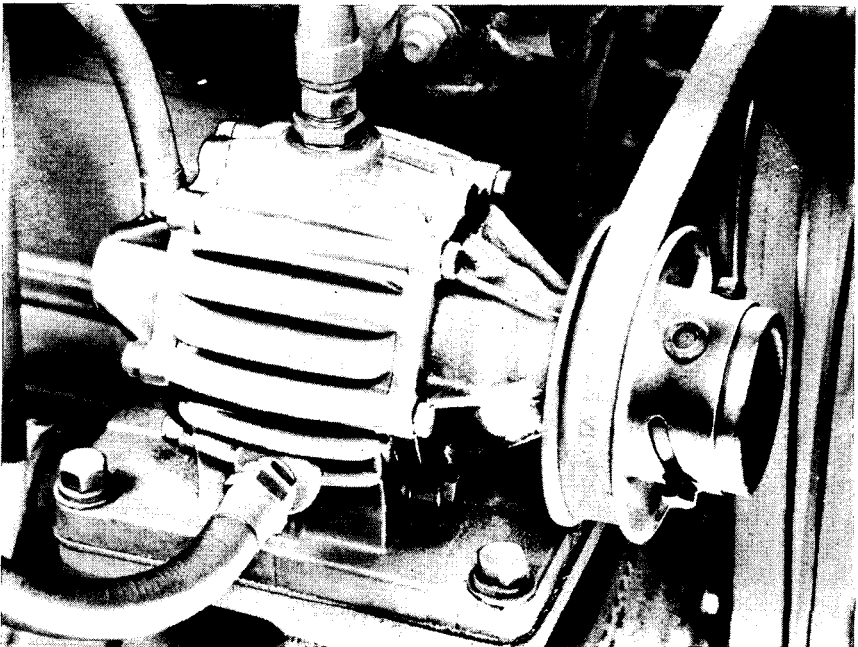

RA PD 13107

Figure 140 — Vacuum Pump - Installed - (Hercules Diesel)

SCOUT CAR M3A1

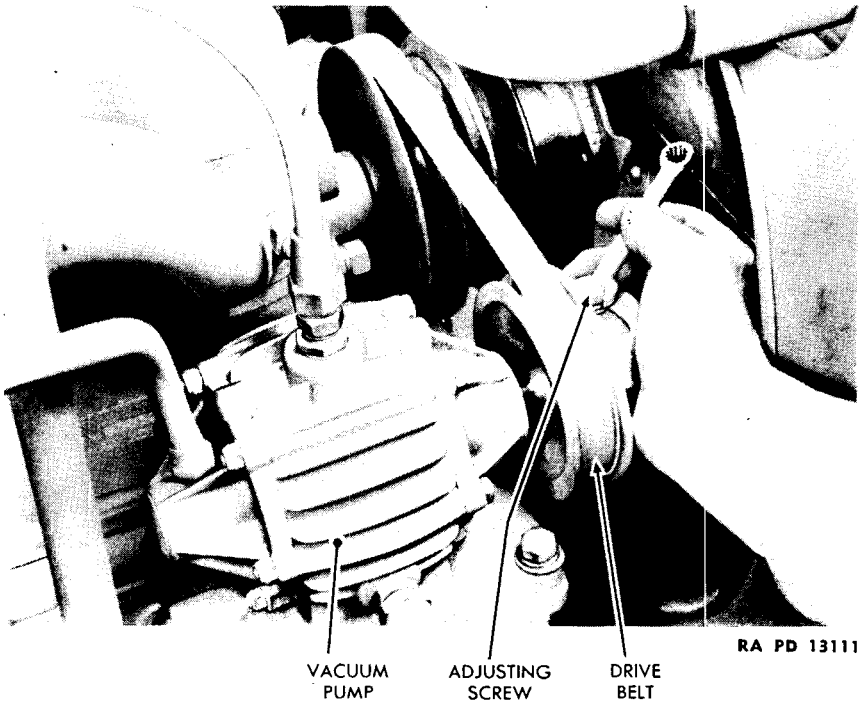

Figure 141 — Adjusting Vacuum Pump Drive Belt - (Hercules Diesel)

(2) REMOVE VALVE SPRINGS.

Tool, valve spring lifting

Place a valve spring lifting tool in position on the cylinder head assembly, as shown in figure 138. Remove the spring clip or snap ring with a screwdriver. Remove the split cone (keepers) seat lock. Release the spring lifting tool and remove the valve spring seat and concentric springs.

(3) REMOVE VALVES.

Rack, valve

Push the valve out. Repeat the same operations for the other eleven valves. As each valve is removed from the cylinder head, place it in a rack suitably marked, so that the valves will be put back in the same places.

c. For grinding valves refer to paragraph 142 c.

d. Valve Installation.

Compressor, valve spring

Straightedge

Gage, feeler

ENGINE (HERCULES DIESEL)

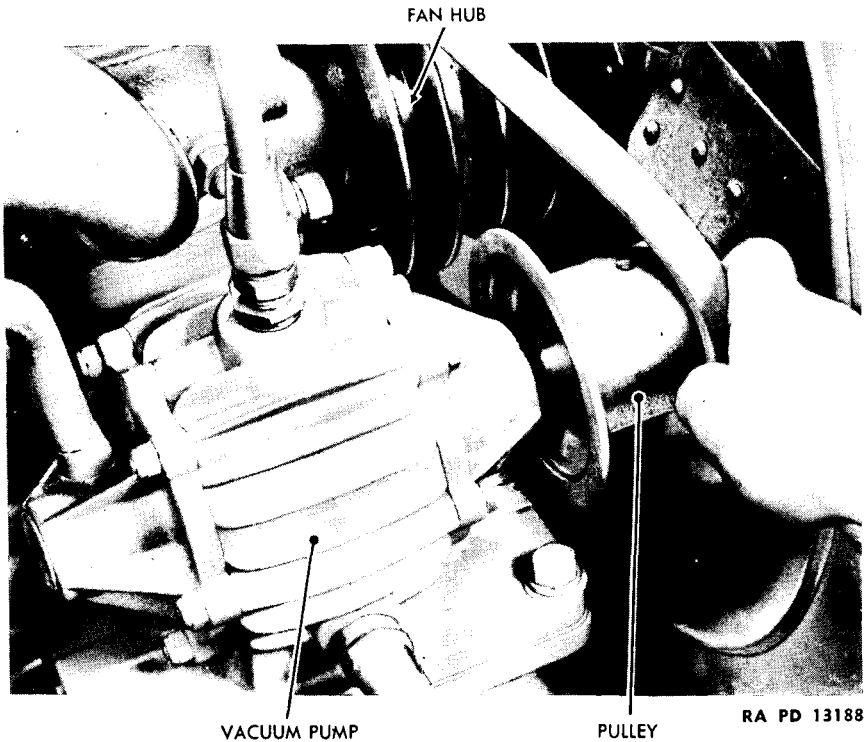

Figure 142 — Removing Belt from Vacuum Pump Drive Pulley - (Hercules Diesel)

(1) PLACE VALVES IN BLOCK AND CHECK CLEARANCE.

Gage, feeler

Straightedge

Install the valves in their correct openings and check clearance with head surface (fig. 139). Place a straightedge over the valve tops and rest it on the cylinder head surface. Use a feeler gage to check the clearance between the valve tops and the cylinder head surface. This clearance is measured between the bottom of the straightedge and the top of each valve and should be between 0.005 inch-0.007 inch. **NOTE:** If clearance is more than 0.007 inch, a new valve should be used. If clearance of a new valve is less than 0.005 inch, the valve should be ground until the 0.005-inch clearance is obtained. If the new valve has a clearance of more than 0.007 inch, ordnance personnel should be notified.

(2) INSTALL SPRING.

Compressor, valve spring

Place the concentric springs and the spring seats in position on the

SCOUT CAR M3A1

OIL LINE TO PUMP

LINE TO CHECK VALVE

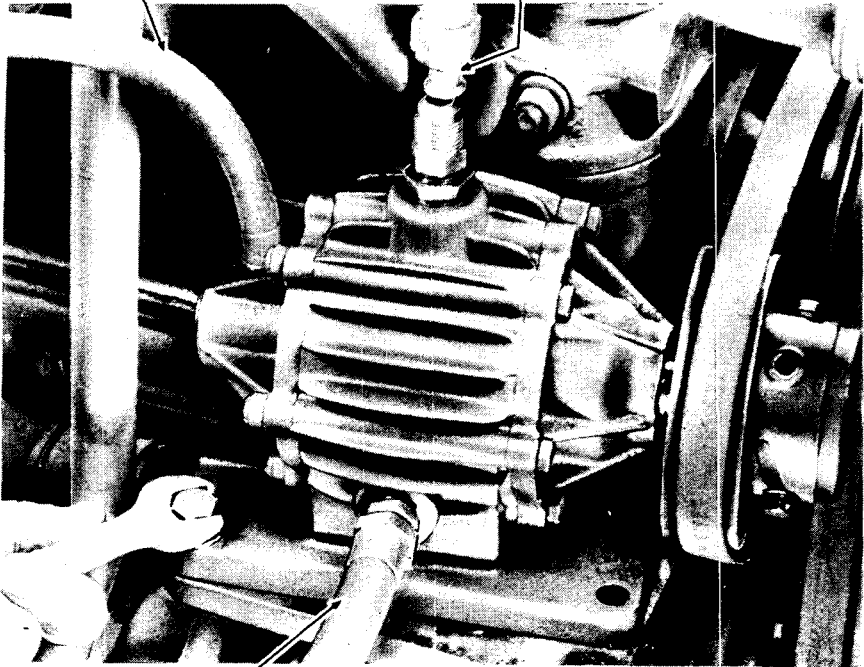

DISCHARGE LINE FROM PUMP

RA PD 13108

Figure 143 — Removal of Vacuum Pump - (Hercules Diesel)

valve stems. Place a valve spring compressing or lifting tool in position and compress the springs. Insert the split cone keepers in their respective grooves in the valve stem. Place a new snap ring in position and remove the tool (fig. 133).

(3) **INSTALL CYLINDER HEAD.** Refer to paragraph 150.

156. CLEANING CARBON.

Whenever the cylinder head is removed, the combustion chambers should be scraped clean of carbon accumulations. When valves are removed, clean the stems of any accumulations. Instead of hand scraping, carbon can be removed by using a wire brush designed for this work and fitted to a small electric drill tool.

157. VACUUM PUMP.

a. **Description** (fig. 140). The vacuum pump is mounted at the front of the engine on the right side, and is belt-driven from the fan pulley. It provides a source of vacuum for the booster brake system.

ENGINE (HERCULES DIESEL)

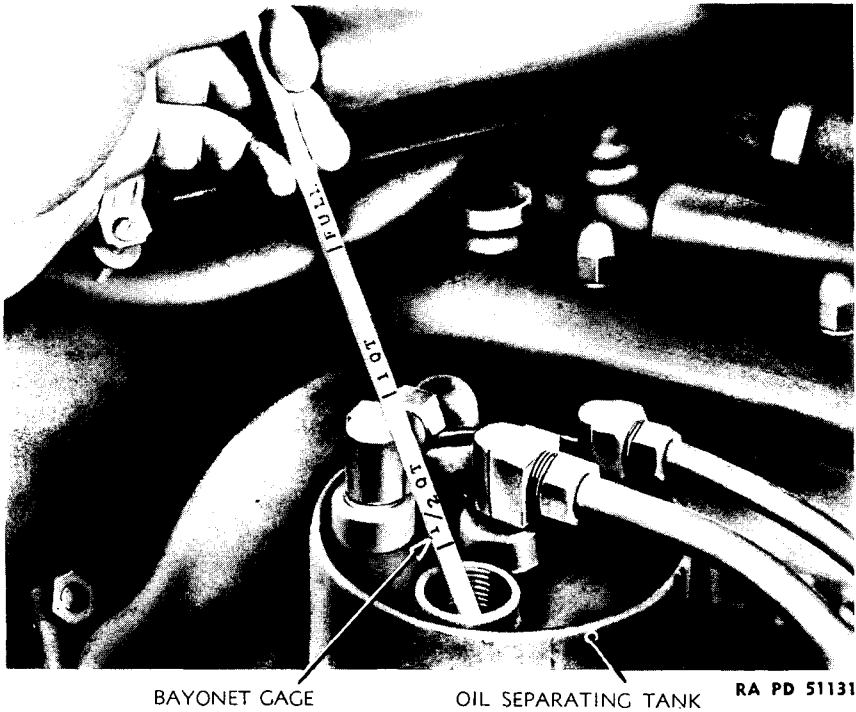

Figure 144 — Checking Oil Level in Vacuum Pump Oil Separating Tank - (Hercules Diesel)

b. Vacuum Pump Belt Adjustment (fig. 141).

Wrench, open-end, $\frac{7}{16}$ -in.

The vacuum pump belt is adjusted by means of an adjusting cap screw in the diagonal slot in the front pulley. The diagonal slot permits the front pulley to be moved forward or backward to secure the required tension on the belt. Adjust the belt to give between $\frac{1}{2}$ -inch and $\frac{3}{4}$ -inch deflection midway between the pulleys.

c. Vacuum Pump Belt Replacement (fig. 142).

Wrench, open-end, $\frac{7}{16}$ -in.

Remove the two adjusting cap screws (fig. 141) and slide the front pulley off the vacuum pump shaft. Slide the belt off the shaft and slip it over the fan (fig. 142). Install a new belt on the fan pulley and on the vacuum pump shaft. Set the front pulley on the shaft, and adjust the belt tension by means of the adjusting screw.

SCOUT CAR M3A1

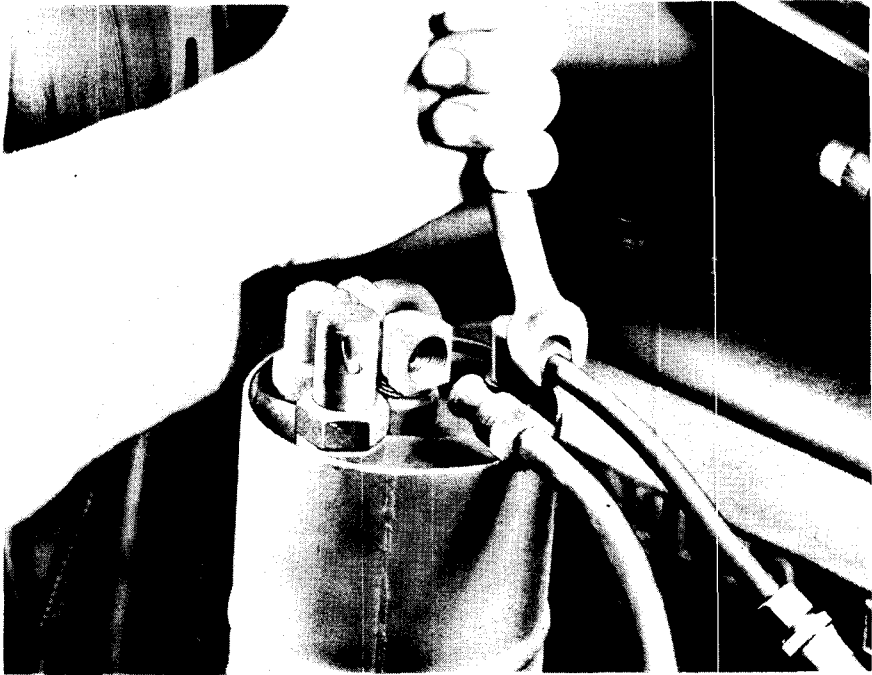

RA PD 13190

Figure 145 — Disconnecting Lines to Oil Separating Tank - (Hercules Diesel)

d. Vacuum Pump Removal.

Wrench, open-end, $\frac{5}{8}$ -in.

Wrench, open-end, $1\frac{3}{8}$ -in.

Wrench, open-end, $\frac{3}{4}$ -in.

Wrench, open-end, $\frac{7}{8}$ -in.

Disconnect the lines to the vacuum pump oil separating tank, using $1\frac{3}{8}$ -inch and $\frac{7}{8}$ -inch open-end wrenches on the union of the discharge line, and $\frac{5}{8}$ -inch and $\frac{3}{4}$ -inch open-end wrenches on the oil line union. Disconnect the tube nut at the top of the vacuum pump, using a $\frac{7}{8}$ -inch open-end wrench. Then use a $\frac{5}{8}$ -inch open-end wrench to remove the flange mounting cap screws (fig. 143). Lift off the vacuum pump.

e. Vacuum Pump Installation (fig. 143).

Wrench, open-end, $\frac{5}{8}$ -in.

Wrench, open-end, $1\frac{3}{8}$ -in.

Wrench, open-end, $\frac{3}{4}$ -in.

Wrench, open-end, $\frac{7}{8}$ -in.

Set the vacuum pump in position and install the flange mounting cap screws, using a $\frac{5}{8}$ -inch open-end wrench. Connect the lines to the oil separating tank, using $1\frac{3}{8}$ -inch and $\frac{7}{8}$ -inch open-end wrenches on the union of one line, and $\frac{5}{8}$ -inch and $\frac{3}{4}$ -inch open-end wrenches on the

ENGINE (HERCULES DIESEL)



ASSEMBLY
PLATES

OIL SEPARATING
TANK

RA PD 51132

**Figure 146 — Engine Vacuum Pump Oil Separating Tank -
(Hercules Diesel)**

SCOUT CAR M3A1

RA PD 41918

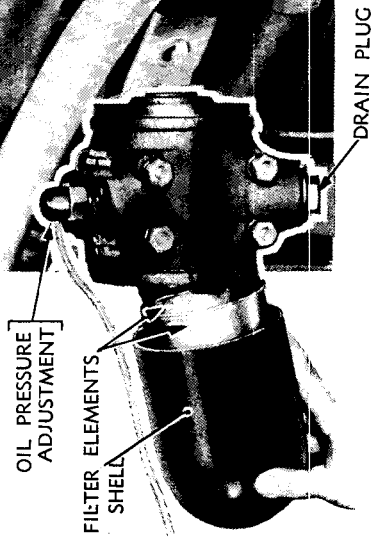
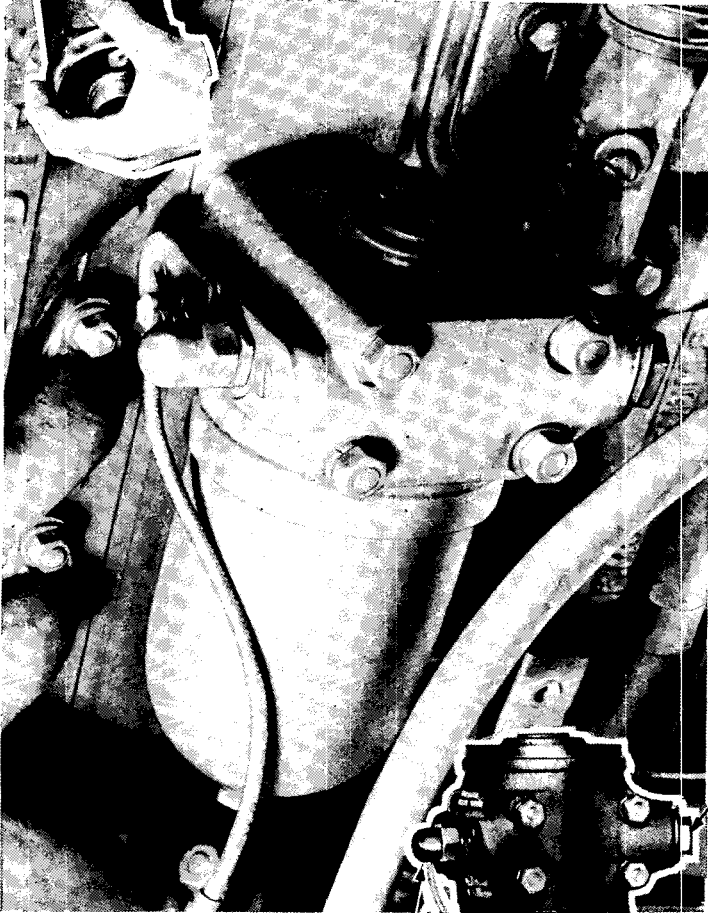

Figure 147 — Crankcase Oil Filter - (Hercules Diesel)

ENGINE (HERCULES DIESEL)

other union. Install the line connection at the top of the vacuum pump, using a $\frac{1}{8}$ -inch open-end wrench. Install and adjust belt to give between $\frac{1}{2}$ -inch and $\frac{3}{4}$ -inch deflection midway between the pulleys.

158. ENGINE VACUUM PUMP OIL SEPARATING TANK.

The oil level in this tank should be maintained at the "full" level on the gage at all times (fig. 144). After each 5,000 miles of operation, the tank should be drained and refilled to the "full" mark with $1\frac{1}{2}$ -quarts of OIL, engine, SAE 10. At least once each year, the tank should be removed and flushed thoroughly with SOLVENT, dry cleaning.

a. Removal.

Screwdriver

Wrench, open-end, $\frac{5}{8}$ -in.

Wrench, open-end, $\frac{7}{16}$ -in.

Wrench, open-end, $1\frac{3}{16}$ -in.

Disconnect the lines from the vacuum pump at the tank, using $\frac{5}{8}$ -inch and $1\frac{3}{16}$ -inch open-end wrenches (fig. 145). Use a screwdriver and a $\frac{7}{16}$ -inch open-end wrench to remove the screws from the assembly plates, and lift out the tank (fig. 146).

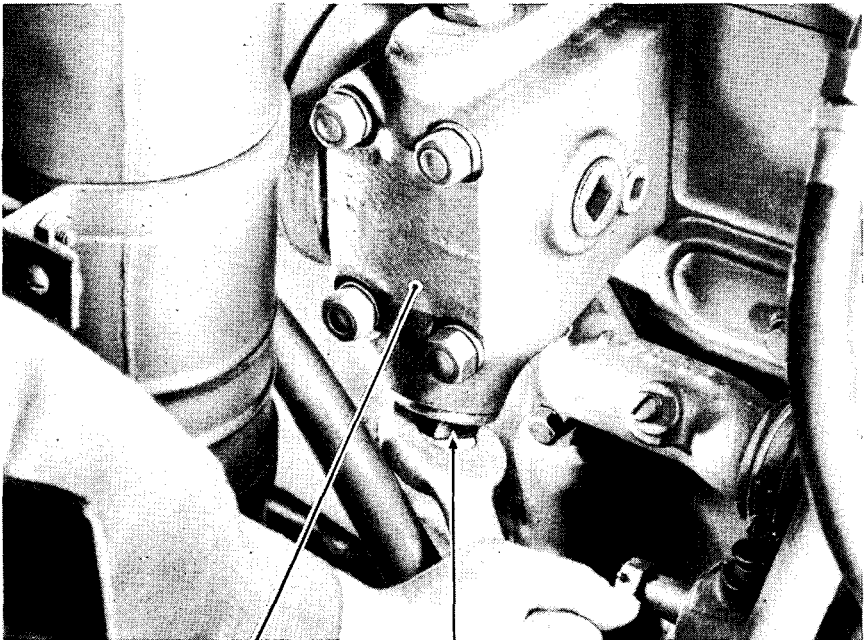

OIL FILTER

DRAIN PLUG

RA PD 13185

Figure 148 — Removal of Drain Plug from Crankcase Oil Filter - (Hercules Diesel)

SCOUT CAR M3A1

b. Installation.

Screwdriver	Wrench, open-end, $\frac{5}{8}$ -in.
Wrench, open-end, $\frac{7}{16}$ -in.	Wrench, open-end, $1\frac{3}{8}$ -in.

Set the tank in position and install the screws in the assembly plates, using a screwdriver and a $\frac{7}{16}$ -inch open-end wrench (fig. 146). Connect the lines from the vacuum pump at the tank (fig. 145).

159. OIL FILTER.

The lubricating oil filter consists of two elements enclosed in a shell. These filtering or straining elements should be cleaned every 500 miles. To clean the elements, pull the shell from filter body and remove elements from the shell. Clean the elements in SOLVENT, dry cleaning or fuel oil, using a clean cloth or a soft bristle brush. Do not use wire or a hard bristle brush or scraper, as these harsh methods will ruin the element. The plug (fig. 148) should be removed every 500 miles to allow dirt, water, and sludge which has accumulated to drain out of the filter.

160. ENGINE REMOVAL.

Extension, ratchet	Wrench, open-end, $\frac{3}{4}$ -in.
Hoist	Wrench, open-end, $\frac{7}{8}$ -in.
Pail	Wrench, open-end, $1\frac{5}{8}$ -in.
Pliers	Wrench, socket, $\frac{9}{16}$ -in.
Rope, length of	Wrench, socket, $\frac{3}{4}$ -in.
Screwdriver, large	Wrench, socket, $1\frac{3}{8}$ -in.
Wrench, open-end, $\frac{3}{8}$ -in.	Wrench, socket, $\frac{7}{16}$ -in., thin-walled
Wrench, open-end, $\frac{7}{16}$ -in.	Wrench, socket, $\frac{7}{8}$ -in., with universal attachment
Wrench, open-end, $\frac{1}{2}$ -in.	
Wrench, open-end, $\frac{9}{16}$ -in.	
Wrench, open-end, $\frac{5}{8}$ -in.	

a. Drain Radiator and Engine Block.

Pail	Pliers
------	--------

Open drain cocks and drain water into pail or on ground.

b. Remove Hood.

Hoist	Screwdriver, large
Rope, length of	Wrench, open-end, $\frac{9}{16}$ -in.

Remove three elastic stop nuts and bolts at rear of center panel of hood. Remove nut and bolt on inside of shutter frame, near the top, on each side of frame. Use rope and hoist to lift off hood, with top of shutter frame left on hood. Hood can also be slipped over front of car by three men.

ENGINE (HERCULES DIESEL)

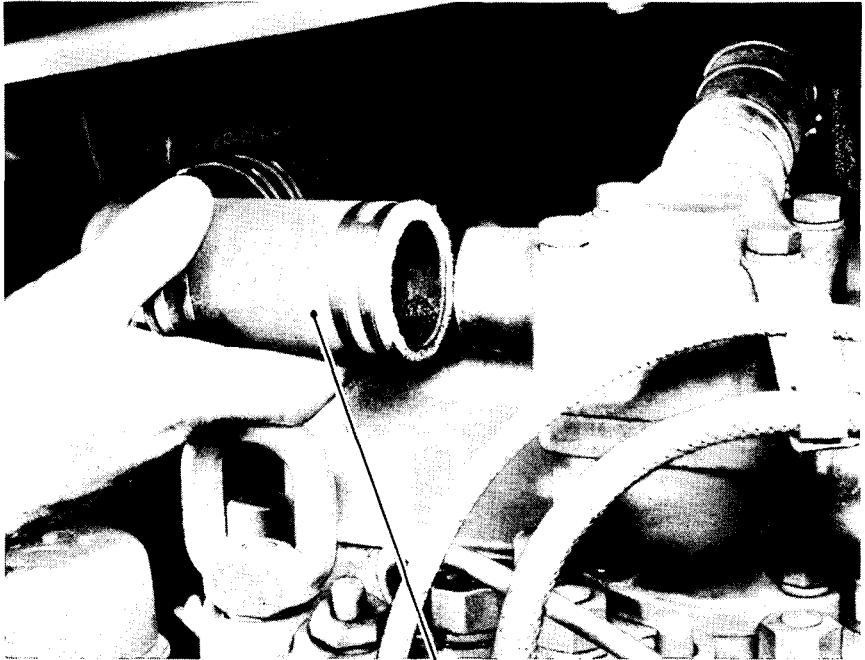

OUTLET HOSE

RA PD 13178

Figure 149 — Disconnecting Hose from Block to Radiator - (Hercules Diesel)

c. Remove Shutter Assembly.

Hoist, chain

Wrench, box, $\frac{9}{16}$ -in.

Screwdriver, heavy-duty

Wrench, open-end, $\frac{1}{2}$ -in.

Remove bolts and nuts that hold the shutter frame to engine side-armor plates. Disconnect shutter control on lower right side of radiator. Lift shutter frame straight up, and out.

d. Remove Radiator Hose Connections.

Screwdriver

Loosen clamps that hold the inlet and outlet radiator hoses, and pull hoses loose from radiator (figs. 149 and 150).

e. Remove Radiator.

Hoist, chain

Wrench, socket, $\frac{7}{8}$ -in., with
universal attachment

Wrench, socket, $\frac{3}{4}$ -in.

Disconnect radiator from cross member by removing holding stud nuts, springs, washers and pads. Then disconnect stay rods at frame by remov-

SCOUT CAR M3A1

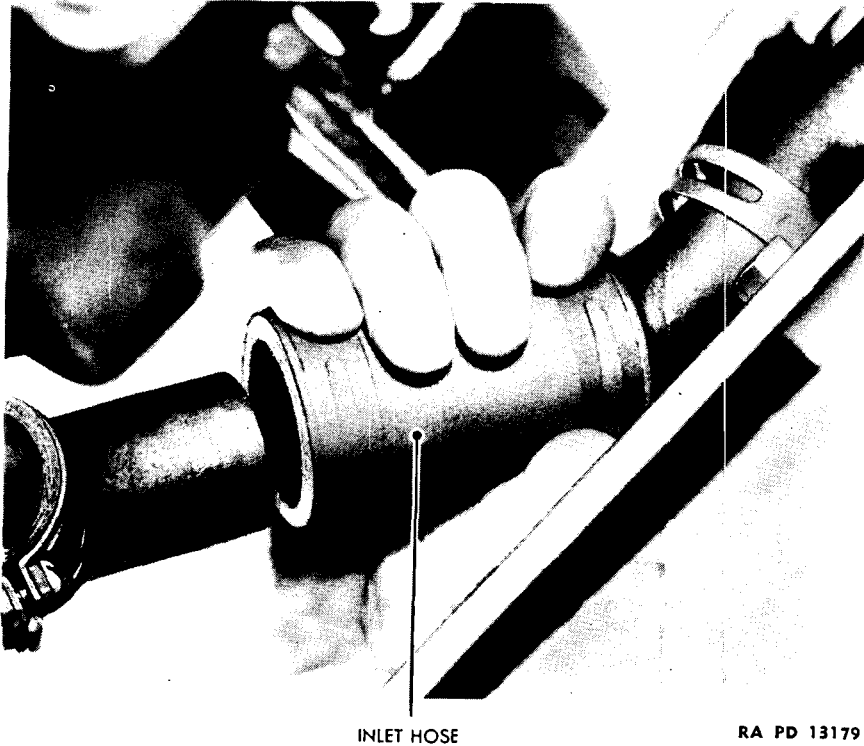

Figure 150 — Removal of Lower Radiator Hose Connection - (Hercules Diesel)

ing nuts from stay rod bolts underneath car, on the bottom side of the top frame flange. Remove radiator assembly from car by lifting up and slightly forward.

f. Remove Heater Inlet and Return Hoses.

Screwdriver

Loosen clamp that holds the inlet hose and pull off hose (fig. 152). Then loosen clamp holding return hose to water pump connection and pull off hose (fig. 151).

g. Disconnect Batteries.

Wrench, open-end, $\frac{9}{16}$ -in.

Remove cap screws and lock washers that hold the battery compartment covers. Loosen nuts clamping cables to battery terminals and pull cables off of terminals. Always pull off negative cable first. Tape cable terminals.

ENGINE (HERCULES DIESEL)

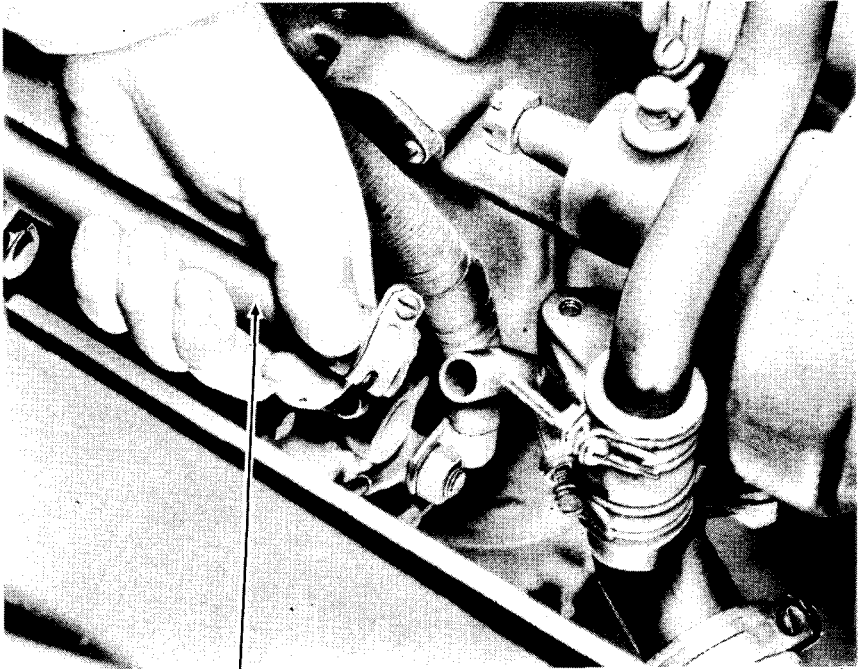

RETURN HOSE

RA PD 13069

Figure 151 — Disconnecting Lower Heat Hose - (Hercules Diesel)

h. Remove Air Intake Pipe.

Screwdriver

Loosen the clamps at the Venturi and at the air cleaner. Remove the pipe (fig. 153).

i. Disconnect Throttle Controls.

Screwdriver

Wrench, open-end, $\frac{7}{16}$ -in.

Use a screwdriver to remove the screw that holds the hand-operated throttle wire at the Venturi. Remove the nut that holds the foot-operated throttle rod at the Venuri lever. Detach the wire and rod (fig. 153).

j. Disconnect Fuel Injector Shut-Off Wire.

Screwdriver

Wrench, open-end, $\frac{3}{8}$ -in.

Disconnect the shut-off wire at the pump.

k. Disconnect Governor Control Wire.

Screwdriver

Wrench, open-end, $\frac{3}{8}$ -in.

Disconnect the control wire at the governor on the fuel pump (fig. 154).

SCOUT CAR M3A1

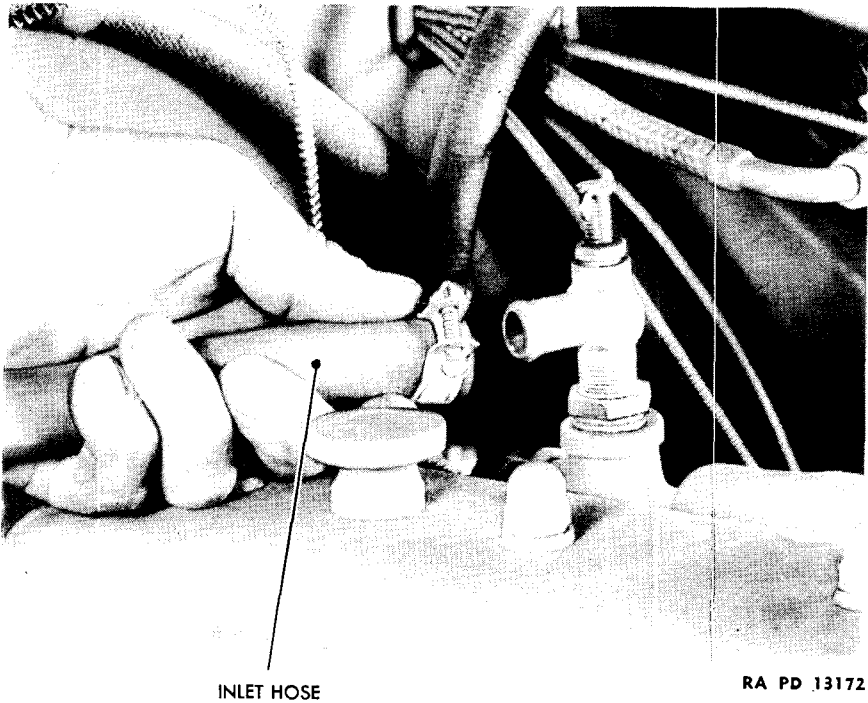

Figure 152 — Disconnecting Upper Heater Hose - (Hercules Diesel)

l. Disconnect Lines to Fuel Transfer Pump.

Wrench, open-end, $\frac{5}{8}$ -in.

Wrench, open-end, $\frac{3}{4}$ -in.

Using a $\frac{3}{4}$ -inch open-end wrench, disconnect the main line from the fuel tank to the fuel transfer pump (fig. 155). Then use a $\frac{5}{8}$ -inch open-end wrench to disconnect the return line on the other side of the pump (fig. 156).

m. Disconnect the Filter Lines.

Wrench, open-end, $\frac{3}{4}$ -in.

Disconnect the fuel line from the pump to the filter at the pump end, using a $\frac{3}{4}$ -inch open-end wrench (fig. 157). Then disconnect the line from the filter to the injector by removing the plug and screen assembly.

n. Disconnect the Generator Wires.

Pliers

Screwdriver

Wrench, open-end, $\frac{5}{8}$ -in.

Wrench, socket, $\frac{7}{16}$ -in.,
thin-walled

Wrench, socket, $\frac{9}{16}$ -in., with
ratchet extension

ENGINE (HERCULES DIESEL)

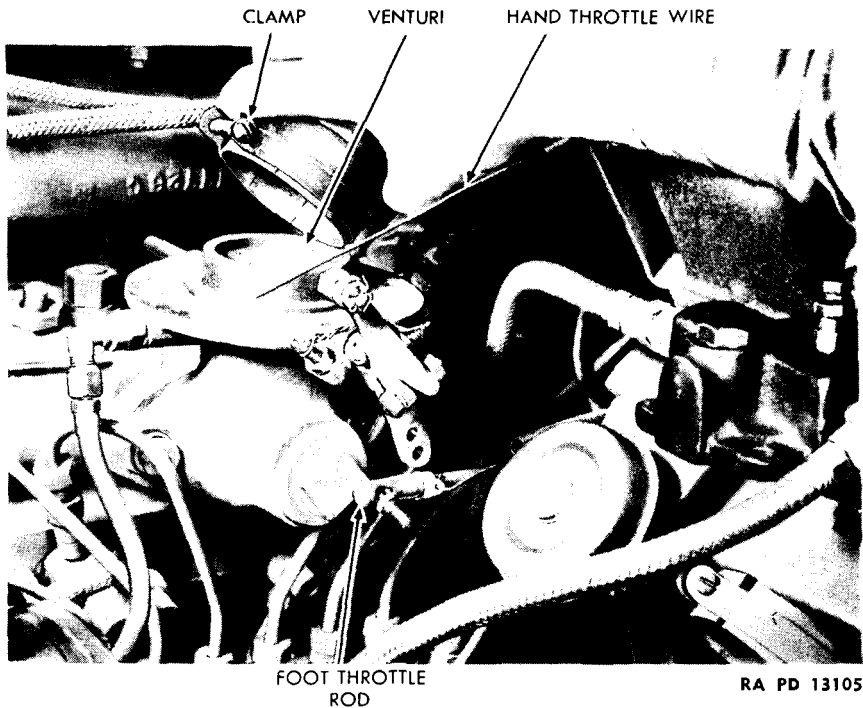

Figure 153 — Disconnecting Air Intake and Hand and Foot Accelerator from Venturi - (Hercules Diesel)

(1) Using pliers, remove the condenser and wire shielding nut. Use a $\frac{9}{16}$ -inch socket wrench with ratchet extension to remove the armature terminal nut.

(2) Remove the plug from the field terminal, using a screwdriver. Then use a $\frac{5}{8}$ -inch open-end wrench to remove the wire shielding nut. Use a thin-walled $\frac{7}{8}$ -inch socket wrench to remove the wire terminal nut.

(3) Remove the stove bolt that clamps the armature and field wires to the thermostat housing.

o. Disconnect Venturi Heater Wire.

Wrench, open-end, $\frac{7}{8}$ -in.

Use a $\frac{7}{8}$ -inch open-end wrench to disconnect the wire from the Venturi intake heater unit (fig. 158).

p. Disconnect the Heat Indicator Unit.

Wrench, open-end, $\frac{5}{8}$ -in.

Disconnect the heat indicator unit from the water jacket at the left rear of the engine (fig. 159).

ENGINE (HERCULES DIESEL)

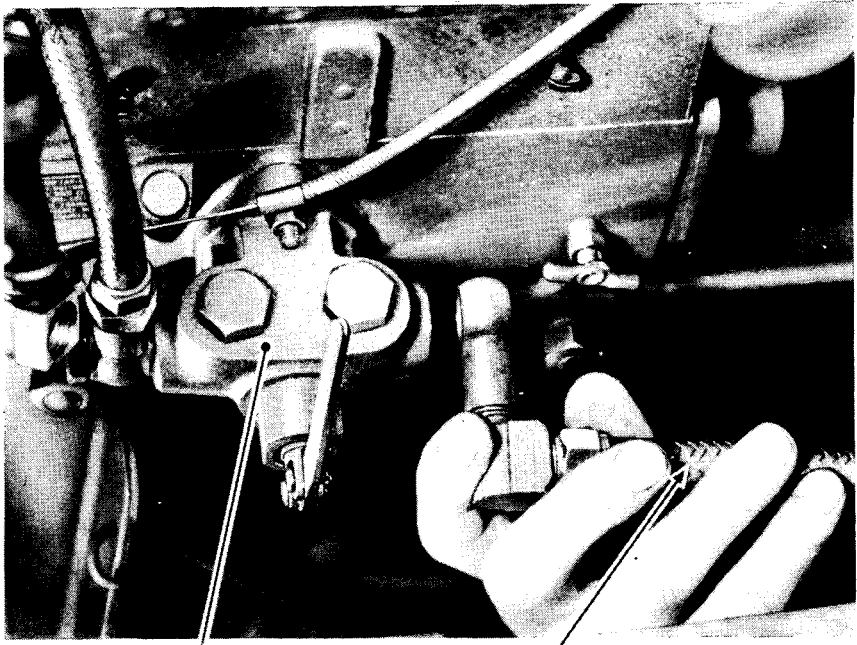

FUEL TRANSFER
PUMP

MAIN LINE TO
FUEL PUMP

RA PD 13106

Figure 155 — Disconnecting Main Line from Fuel Tank to Pump - (Hercules Diesel)

s. Disconnect the Oil Gage Line.

Wrench, open-end, $\frac{7}{16}$ -in.

Wrench, open-end, $\frac{1}{2}$ -in.

Disconnect the oil filter to dash gage line at the union, as shown in figure 162.

t. Disconnect the Exhaust Manifold.

Wrench, open-end, $\frac{3}{4}$ -in.

Wrench, open-end, $\frac{7}{8}$ -in.

Disconnect the exhaust manifold from the exhaust pipe at the rear of the engine by removing the bolts from the mounting flange (fig. 162).

u. Remove the Starter.

Wrench, open-end, $\frac{7}{8}$ -in.

Wrench, open-end, $\frac{7}{8}$ -in.

Wrench, open-end, $\frac{3}{4}$ -in.

Remove the starter terminals from the starter, using a $\frac{3}{4}$ -inch open-end wrench on the two large terminals, and a $\frac{7}{8}$ -inch open-end wrench on the small terminal. Remove the starter cable from the block (fig. 163). Then remove the starter by taking out the three cap screws with a $\frac{7}{8}$ -inch open-end wrench.

SCOUT CAR M3A1

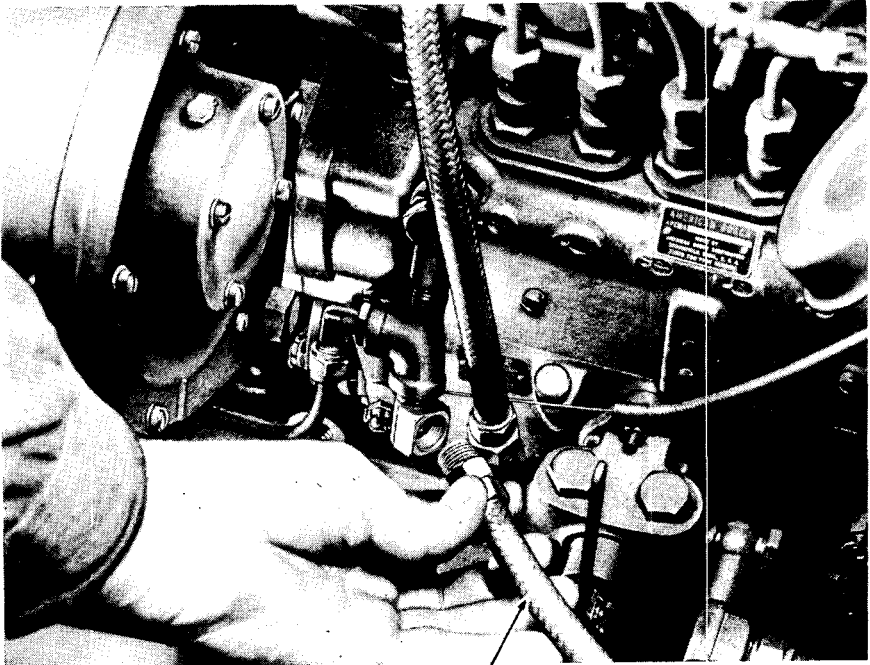

RETURN FUEL LINE

RA PD 13169

Figure 156 — Disconnecting Return Fuel Line - (Hercules Diesel)

v. Disconnect Brake Vacuum Booster.

Pliers

Disconnect the brake vacuum booster from the bracket by removing the clevis pin from the clevis on the rear of the booster, using pliers.

w. Remove Floor Plate over Transmission.

Screwdriver

Unscrew and remove the transfer case shift lever ball. Remove seven machine screws that hold center floor plate and remove the plate. **NOTE:** Cover is easily removed by first lifting front section over extended section of dash and then lifting rear section.

x. Disconnect Propeller Shaft.

Wrench, open-end, $\frac{5}{8}$ -in. (two)

Remove four nuts, lock washers and bolts that hold propeller shaft to the companion flange on transmission, and separate propeller shaft from companion flange.

ENGINE (HERCULES DIESEL)

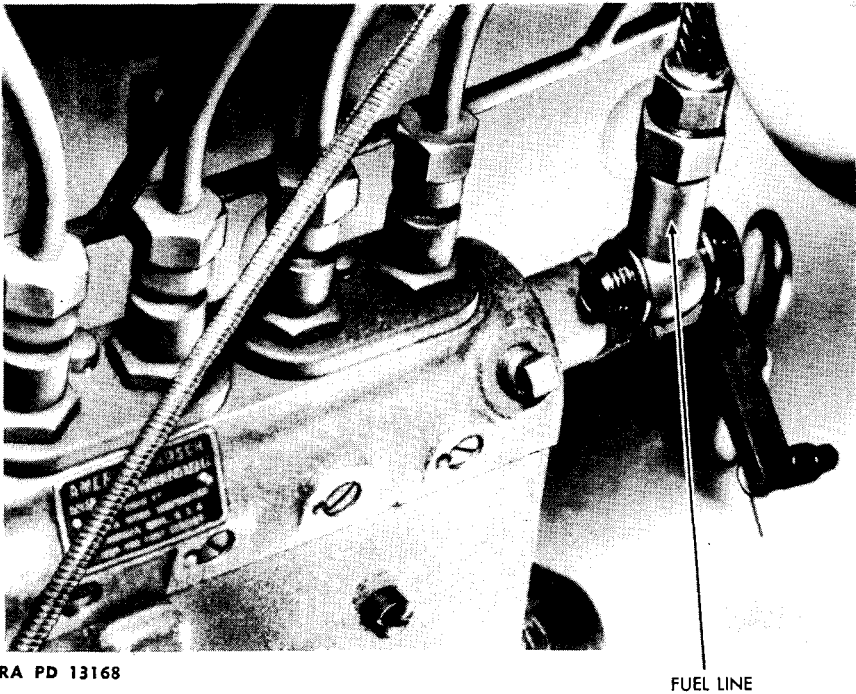

**Figure 157 — Disconnecting Line from Fuel Filter to Pump -
(Hercules Diesel)**

y. Remove Clutch Release Bearing Outer Oil Tube.

Wrench, open-end, $\frac{7}{16}$ -in.

Wrench, socket, $\frac{9}{16}$ -in.

Unscrew inverted flared tube nut from elbow on bell housing. ($\frac{7}{16}$ -in. open-end wrench). Remove cap screw and lock washer holding oil tube clip to bell housing ($\frac{9}{16}$ -in. socket wrench) and lift out oil tube.

z. Remove Transfer Case Shift Lever.

Wrench, socket, $\frac{9}{16}$ -in.

Remove two cap screws and lock washers securing transfer case shift lever to transmission and lift assembly out of the way.

aa. Remove Hand Brake Lever.

Screwdriver

Wrench, socket, $\frac{9}{16}$ -in.

Release hand brake and remove the two nuts and lock washers that secure the hand brake lever assembly to transmission ($\frac{9}{16}$ -in. socket wrench). Pry hand brake lever assembly away from studs on transmission (screwdriver) and allow it to drop down out of the way.

SCOUT CAR M3A1

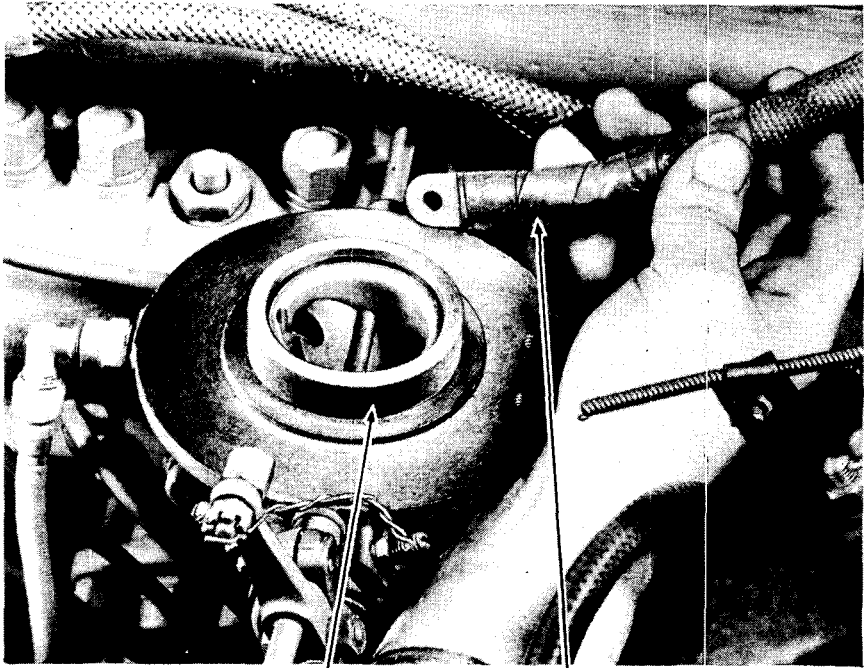

VENTURI

VENTURI HEATER WIRE

RA PD 13170

Figure 158 — Disconnecting Heater Element at Venturi - (Hercules Diesel)

bb. Remove Transmission Shift Lever.

Wrench, socket, $\frac{9}{16}$ -in.

Remove four cap screws and lock washers and lift off shift lever and top assembly. Cover opening to prevent dirt from entering transmission.

cc. Remove Clutch Release Pedal Shaft Lever.

Hammer

Wrench, open-end, $\frac{9}{16}$ -in. (two)

Pliers

Remove cotter pin and pull out clevis pin at clutch release pedal shaft lever. Loosen nut on cap screw clamping lever to shaft ($\frac{9}{16}$ -inch open-end wrenches (two)) and drive off lever. Remove lubricating fitting from shaft support to prevent it from breaking off when removing engine ($\frac{7}{16}$ -inch open-end wrench).

dd. Prepare Engine for Removal.

Hoist

Rope, Manila, $\frac{3}{4}$ -in.

(at least 14 feet)

Tie rope around engine in a figure eight. Place hoist hook in balanced

ENGINE (HERCULES DIESEL)

place of rope (slightly to rear of engine) and remove slack in rope by raising hook.

ee. Disconnect Engine Supports.

Handle, ratchet

Wrench, open-end, $\frac{1}{8}$ -in.

Pliers

Wrench, socket, $\frac{3}{4}$ -in.

Wrench, open-end, $\frac{3}{4}$ -in.

Wrench, socket, $\frac{1}{8}$ -in.

Remove cotter pins from castellated nuts at rear support bolts and remove the nuts, bolts, washers, and right support spring. Remove four nuts, lock washers and cap screws from the front engine supports (fig. 126).

ff. **Remove Engine Assembly.** Lift engine until free of supports and move straight forward until transmission is clear of dash. **NOTE:** Use care in guiding engine out to prevent clutch lever shaft from catching on engine support brackets. Lift engine, with transmission, out of vehicle and place in stand, or on blocks.

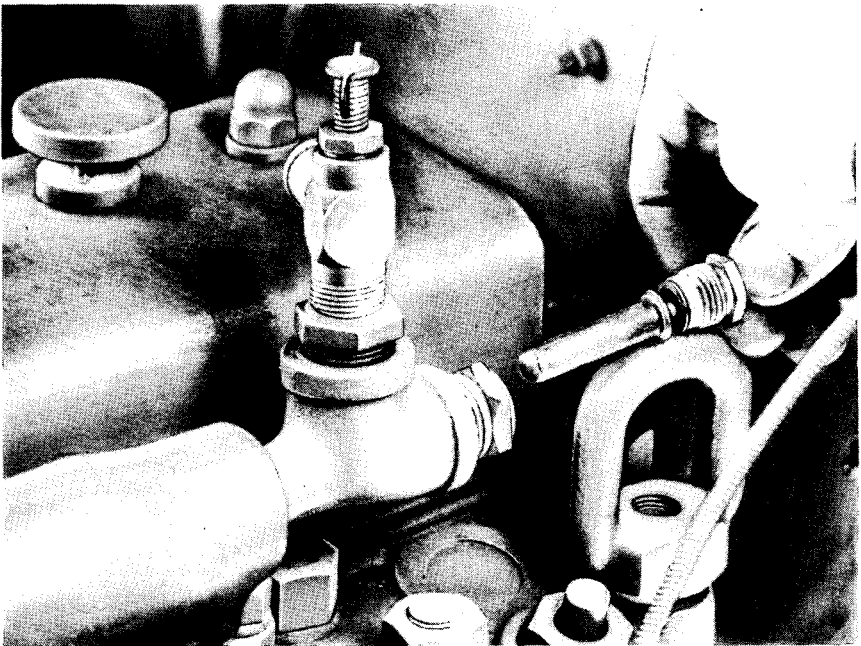

RA PD 13171

Figure 159 — Disconnecting Heat Indicator Unit - (Hercules Diesel)

SCOUT CAR M3A1

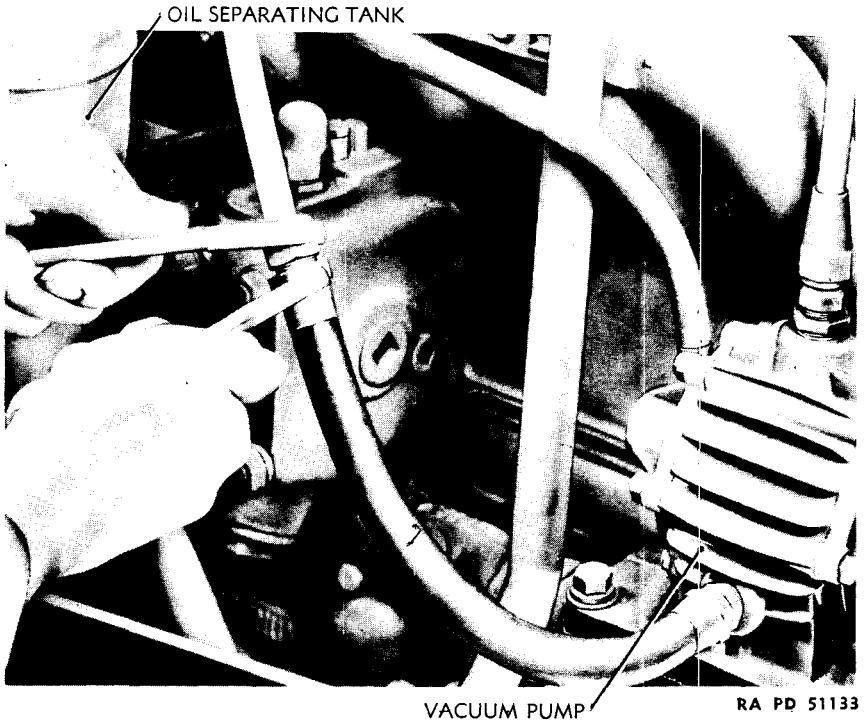

Figure 160 — Disconnecting Line from Vacuum Pump to Oil Separating Tank - (Hercules Diesel)

161. ENGINE INSTALLATION.

- | | |
|----------------------------|---|
| Crank | Wrench, open-end, 1/2-in. |
| Extension, ratchet | Wrench, open-end, 9/16-in. (two) |
| Hammer | Wrench, open-end, 5/8-in. |
| Hoist, chain | Wrench, open-end, 3/4-in. |
| Pail (or hose) | Wrench, open-end, 7/8-in. |
| Pliers | Wrench, open-end, 1 1/8-in. |
| Rope, Manila, 3/4-in. | Wrench, socket, 9/16-in. |
| Screwdriver | Wrench, socket, 3/4-in. |
| Screwdriver, heavy | Wrench, socket, 1 1/8-in. |
| Wrench, box, 9/16-in. | Wrench, socket, 7/8-in.,
thin-walled |
| Wrench, open-end, 3/8-in. | Wrench, socket, 7/8-in., with
universal attachment |
| Wrench, open-end, 7/16-in. | |

a. Place Engine Assembly in Vehicle.

- | | |
|-------|-----------------------|
| Hoist | Rope, Manila, 3/4-in. |
|-------|-----------------------|

With transmission mounted on engine, place rope around the assembly in a figure eight. Place hoist hook in balanced position on rope and raise

ENGINE (HERCULES DIESEL)

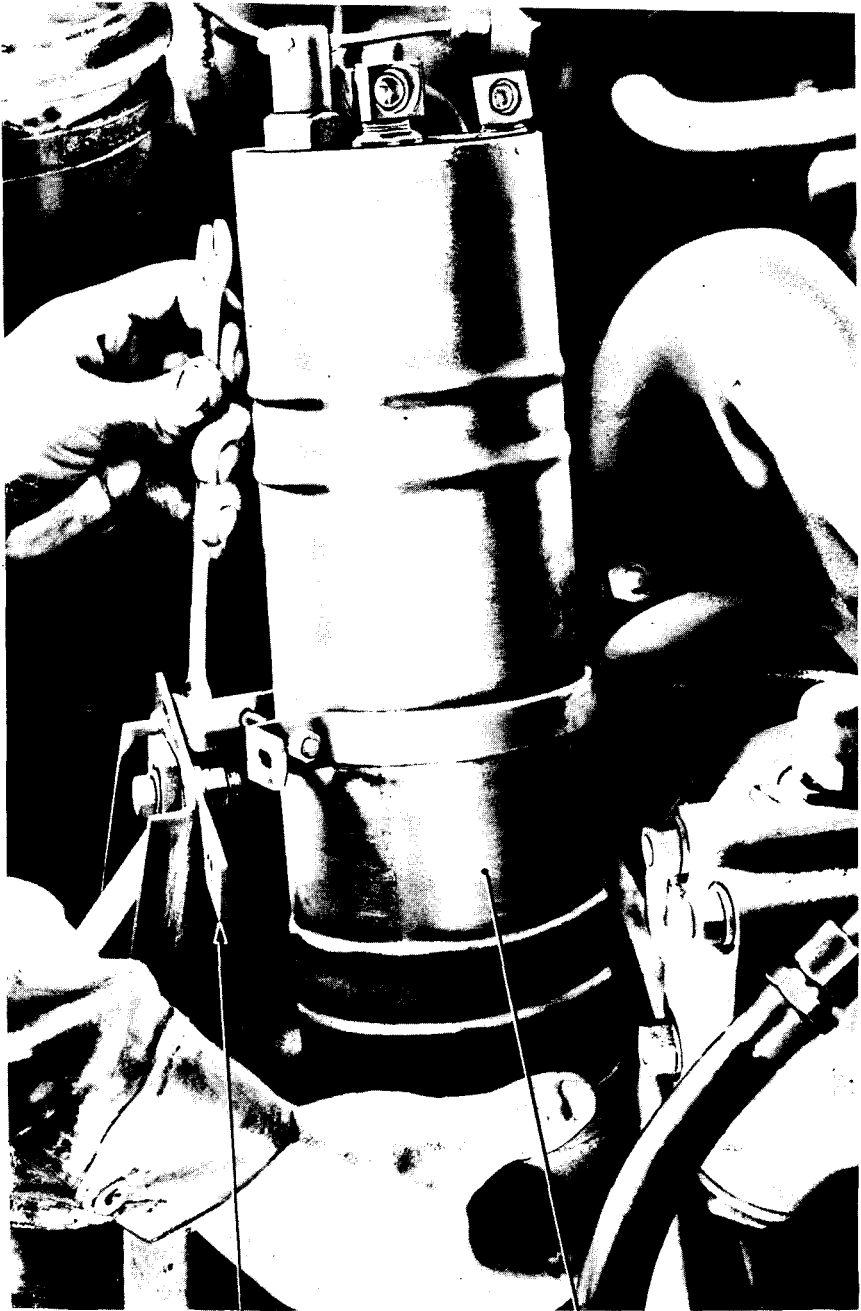

ASSEMBLY PLATE

OIL SEPARATING TANK

RA PD 51134

**Figure 161 — Removing Vacuum Pump Oil Separating Tank -
(Hercules Diesel)**

SCOUT CAR M3A1

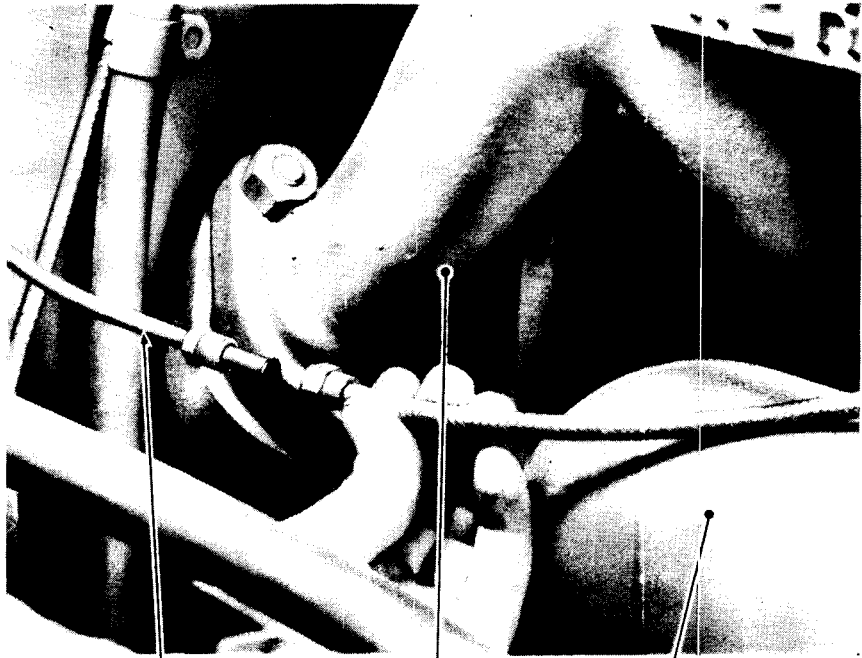

OIL GAGE LINE

EXHAUST MANIFOLD

OIL FILTER

RA PD 13177

Figure 162 — Disconnecting Oil Line to Gage - (Hercules Diesel)

engine assembly high enough to clear front frame cross member. Carefully guide engine assembly into position on rear engine support brackets. NOTE: Place pads on support brackets before engine is finally positioned.

b. Bolt Engine Assembly to Frame.

Handle, ratchet

Wrench, open-end, $\frac{1}{8}$ -in.

Pliers

Wrench, socket, $\frac{3}{4}$ -in.

Wrench, open-end, $\frac{3}{4}$ -in.

Wrench, socket, $\frac{1}{8}$ -in.

Secure rear engine supports with plain washers, bolt and castle nut on left side ($\frac{1}{8}$ -in. socket wrench and $\frac{1}{2}$ -in. open-end wrench) and plain washers, bolt, spring and castle nut on right side ($\frac{3}{4}$ -in. socket wrench and $\frac{3}{4}$ -in. open-end wrench). Install cotter pins in castle nuts and lock pins (pliers). Bolt front trunnion to frame with four cap screws, lock washers and nuts ($\frac{3}{4}$ -in. socket wrench and $\frac{3}{4}$ -in. open-end wrench).

c. Install Transmission Shift Lever Assembly.

Wrench, socket, $\frac{9}{16}$ -in.

Place lever and cover assembly over transmission cover, guiding lever into position on lugs in transmission cover. Secure lever and cover assembly with four cap screws and lock washers.

ENGINE (HERCULES DIESEL)



STARTER CABLE

RA PD 13140

**Figure 163 — Removing Starter Cable from Block -
(Hercules Diesel)**

d. Install Clutch Release Bearing Outer Oil Tube.

Wrench, open-end, $\frac{7}{16}$ -in.

Wrench, socket, $\frac{9}{16}$ -in.

Place oil tube in position and screw inverted flared tube nut into elbow on bell housing ($\frac{7}{16}$ -in. open-end wrench). Secure tube clip to bell housing with cap screw and lock washer.

e. Install Transfer Case Shift Lever.

Wrench, socket, $\frac{9}{16}$ -in.

Mount transfer case shift lever assembly on transmission cover and secure with two cap screws and lock washers.

f. Install Hand Brake Lever.

Wrench, socket, $\frac{9}{16}$ -in.

Slip hand brake lever assembly over studs on transmission and secure with two nuts and lock washers.

g. Connect Propeller Shaft.

Wrench, open-end, $\frac{5}{8}$ -in. (two)

Connect propeller shaft to transmission companion flange with four cap screws, lock washers and nuts.

SCOUT CAR M3A1

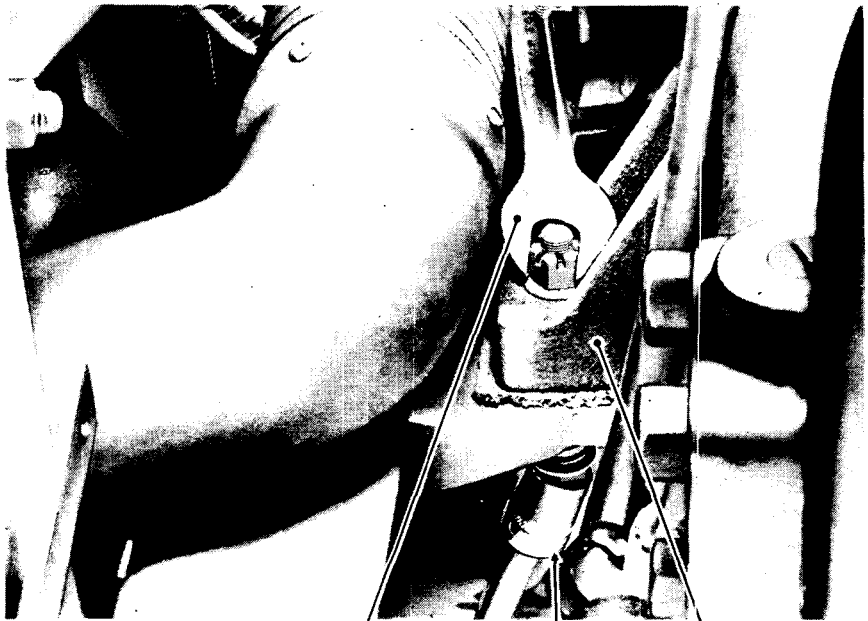

RA PD 13176

OPEN END
WRENCH

SOCKET
WRENCH

ENGINE
SUPPORT

**Figure 164 — Removing Rear Engine Support Bolt -
(Hercules Diesel)**

h. Install Clutch Release Shaft Lever.

Hammer
Pliers

Wrench, open-end, $\frac{9}{16}$ -in. (two)

With Woodruff key in position on shaft, replace lever and secure with cap screw, nut and lock washer ($\frac{9}{16}$ -in. open-end wrenches (two)). Connect clevis to lever with clevis pin, and lock clevis pin with cotter pin. Check for proper travel of clutch pedal (par. 72).

i. Replace Floor Plate over Transmission.

Screwdriver

Place floor plate in position over transmission and secure with seven machine screws.

j. Attach Brake Vacuum Booster.

Pliers

Attach brake vacuum booster to bracket by inserting clevis pin in clevis at rear of booster.

ENGINE (HERCULES DIESEL)

k. Install the Starter.

Wrench, open-end, $\frac{7}{16}$ -in.

Wrench, open-end, $\frac{7}{8}$ -in.

Wrench, open-end, $\frac{3}{4}$ -in.

Place the starter in position and install the three cap screws that hold the starter in place. Use a $\frac{7}{8}$ -inch open-end wrench to tighten the cap screws. Then connect the starter terminals to the starter. Use a $\frac{7}{16}$ -inch open-end wrench to attach the small terminal, and a $\frac{3}{4}$ -inch open-end wrench to tighten the two large terminals.

l. Connect the Exhaust Manifold.

Wrench, open-end, $\frac{3}{4}$ -in.

Wrench, open-end, $\frac{7}{8}$ -in.

Install a new gasket between the exhaust manifold and the exhaust pipe flanges. Insert and tighten the bolts and nuts.

m. Connect the Oil Gage Line.

Wrench, open-end, $\frac{7}{16}$ -in.

Wrench, open-end, $\frac{1}{2}$ -in.

Join the oil filter to the dash gage line at the union, and tighten (fig. 162).

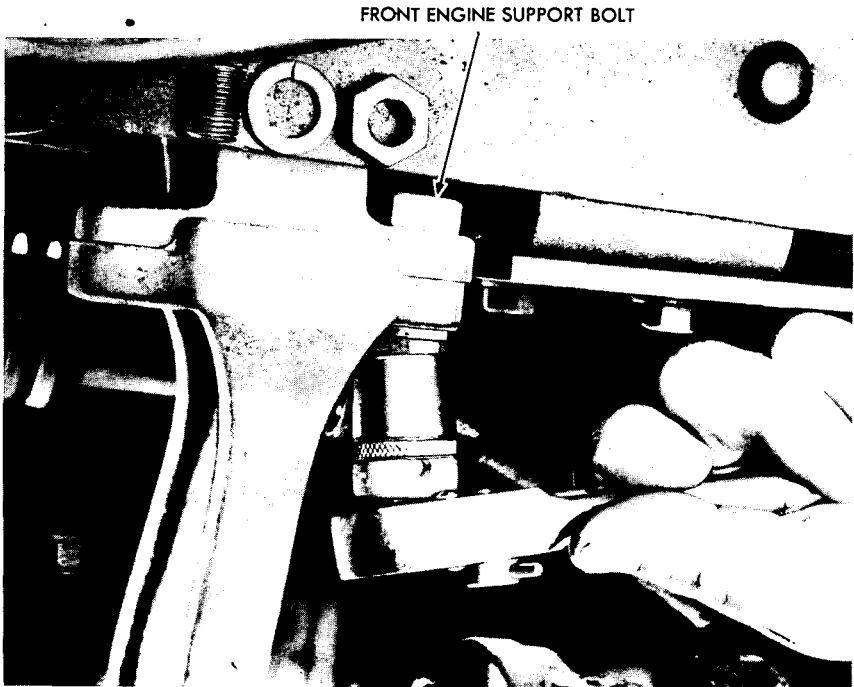

RA PD 13175

**Figure 165 — Disconnecting Front Engine Support -
(Hercules Diesel)**

SCOUT CAR M3A1**n. Connect Vacuum Pump Lines.**

Screwdriver

Wrench, open-end, $\frac{5}{8}$ -in.Wrench, open-end, $\frac{7}{16}$ -in.Wrench, open-end, $\frac{7}{8}$ -in.

Hold the vacuum pump oil and exhaust tank in position against the mounting bracket and insert the stove bolts (fig. 161). Use a screwdriver and $\frac{7}{16}$ -inch open-end wrench to tighten the bolts. Install the vacuum line and hose from the pump to the screen and check valve on the dash ($\frac{7}{8}$ -in. open-end wrench and screwdriver). Connect the other vacuum pump lines ($\frac{7}{8}$ -in. and $\frac{5}{8}$ -in. open-end wrenches).

o. Install the Left Air Funnel Assembly.

Screwdriver

Wrench, open-end, $\frac{9}{16}$ -in.

Place the funnel assembly in position at ventilator box inlet, and tighten clamp. Insert and tighten the cap screw, lock washer and nut that hold funnel support clamp to bracket.

p. Connect the Heat Indicator Unit.Wrench, open-end, $\frac{5}{8}$ -in.

Connect the heat indicator unit to the water jacket at the left rear of the engine (fig. 159).

q. Connect the Venturi Heater Wire.Wrench, open-end, $\frac{7}{16}$ -in.

Connect the wire to the Venturi (intake heater unit (fig. 158)).

r. Connect the Generator Wires.

Pliers

Wrench, socket, $\frac{7}{16}$ -in.,

Screwdriver

thin-walled

Wrench, open-end, $\frac{5}{8}$ -in.Wrench, socket, $\frac{9}{16}$ -in., with
ratchet extension.

(1) Place the armature and field wires in position at the thermostat housing, and insert and tighten the stove bolt that clamps them to the housing.

(2) Install the field terminal cable and, using a thin-walled, $\frac{7}{16}$ -inch socket wrench, install the field terminal nut. Install the wire shielding, using a $\frac{5}{8}$ -inch open-end wrench. Then, using a screwdriver, install the plug on the field terminal.

(3) Install the armature terminal cable and the armature terminal nut, using a $\frac{9}{16}$ -inch socket wrench with ratchet. Then install the condenser and wire shielding nut, using pliers.

ENGINE (HERCULES DIESEL)

s. Connect the Fuel Filter Lines.

Wrench, open-end, $\frac{3}{4}$ -in.

Connect the line from the filter to the injector by attaching the plug and screen assembly. Connect the fuel line from the pump to the filter at the pump end, using a $\frac{3}{4}$ -inch open-end wrench (fig. 157).

t. Connect Lines to Fuel Transfer Pump.

Wrench, open-end, $\frac{5}{8}$ -in.

Wrench, open-end, $\frac{3}{4}$ -in.

Connect the main line from the fuel tank to the fuel transfer pump, using a $\frac{3}{4}$ -inch open-end wrench (fig. 155). Connect the fuel return line on the other side of the pump, using a $\frac{5}{8}$ -inch open-end wrench (fig. 156).

u. Connect Governor Control Wire.

Screwdriver

Wrench, open-end, $\frac{3}{8}$ -in.

Connect the control wire at the governor on the fuel pump (fig. 154).

v. Connect Fuel Injector Shut-Off Wire.

Screwdriver

Wrench, open-end, $\frac{3}{8}$ -in.

Connect the shut-off wire at the pump.

w. Connect the Throttle Controls.

Screwdriver

Wrench, open-end, $\frac{7}{16}$ -in.

Put the throttle wire and rod in place. Using a screwdriver, install the screw that holds the hand-operated throttle wire at the Venturi. Then, install the nut that holds the foot-operated throttle rod at the Venturi lever (fig. 153).

x. Install Air Intake Pipe.

Screwdriver

Place the air intake pipe in position and tighten the clamps at the Venturi and at the air cleaner (fig. 153).

y. Connect the Batteries.

Wrench, open-end, $\frac{9}{16}$ -in.

Remove tape from battery cable terminals. Attach the positive cable first, then attach the negative cable, and tighten the nuts. Put on the battery compartment covers, and insert and tighten the cap screws and lock washers.

z. Install Heater Inlet and Return Hoses.

Screwdriver

Slide the return hose onto the water pump connection, and tighten the clamp. Install the inlet hose, and tighten the clamp (figs. 151 and 152).

SCOUT CAR M3A1**aa. Install Radiator.**

Hoist, chain

Wrench, socket, $\frac{7}{8}$ -in., with
universal attachmentWrench, socket, $\frac{3}{4}$ -in.

Place holding stud pads in position on cross member. Using a chain hoist, carefully swing the radiator assembly into position on the car. Connect the stay rods at the frame by installing stay rod bolts and nuts underneath car, on the top frame flange. Connect radiator to cross member by installing washers, springs and nuts.

bb. Install Radiator Hose Connections.

Screwdriver

Install the inlet and outlet radiator hoses and tighten the hose clamps (figs. 149 and 150).

cc. Install the Shutter Assembly.

Hoist, chain

Wrench, box, $\frac{9}{16}$ -in.

Screwdriver, heavy-duty

Wrench, open-end, $\frac{1}{2}$ -in.

Carefully lower shutter into position, using a chain hoist. Connect shutter control on lower right side of radiator. Insert and tighten the bolts and nuts that hold the shutter frame to the engine side-armor plates.

dd. Install Hood.

Hoist

Screwdriver, large

Rope, length of

Wrench, open-end, $\frac{9}{16}$ -in.

Use a rope and hoist to lift hood (with top of shutter frame attached to hood) into position. NOTE: Hood can also be slipped over front of car into position by three men. Install and tighten the nut and bolt on inside of shutter frame, near the top, on each side of frame. Install the three elastic stop nuts and bolts at rear of center panel of hood.

ee. Prepare Vehicle for Road.

Pail (or hose)

Pliers

Be sure all drain cocks are tightly closed. Fill cooling system with liquid. Check oil level in crankcase. Start engine and check oil pressure, and check cooling system and lubricating system for leaks.

Section XXIII

ENGINE (BUDA-LANOVA DIESEL)

	Paragraph
General description	162
Characteristics	163
Trouble shooting	164
Cylinder head removal	165
Cylinder head installation.....	166
Removal and installation of valves.....	167
Cleaning carbon	168
Flywheel marking	169
Removal and installation of manifold.....	170
Removal and installation of oil pan.....	171
Oil pump	172
Engine removal	173
Engine installation	174

162. GENERAL DESCRIPTION (figs. 166, 167, 168 and 169).

The Buda-Lanova Diesel engine is of the four-cycle, compression-ignition, solid-injection type. Cylinders are numbered from the timing gear end. Rotation is determined by viewing engine from the timing gear end. The cylinder head is the overhead-valve type. Valves are operated by the conventional rocker arm and push rod mechanism. The crankcase and cylinder housing are cast integral. Removable cylinder sleeves of the dry type are used, firmly clamped in place by the cylinder head. Pistons and connecting rods are removable from the top of the engine. The pistons are aluminum alloy.

163. CHARACTERISTICS.

Model	6DT-317
Cylinders	6
Bore	3 $\frac{5}{8}$ -in.
Stroke	5 $\frac{1}{8}$ -in.
Displacement (cubic inches).....	317
American Manufacturers' Association horsepower.....	31.54
Brake horsepower at 2,300 rpm.....	81
Maximum torque at 1,200-1,600 rpm (foot-pounds).....	220
Firing order	1-5-3-6-2-4

164. TROUBLE SHOOTING.

Refer to paragraph 148.

SCOUT CAR M3A1

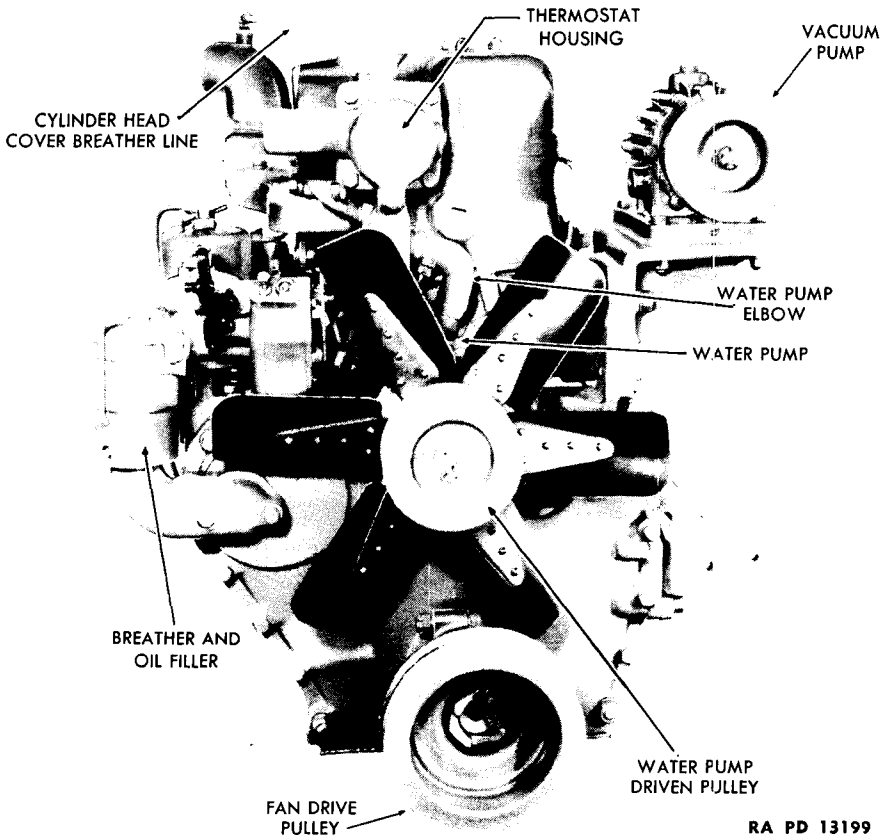

RA PD 13199

Figure 166 — Front View of Buda Diesel Engine

165. CYLINDER HEAD REMOVAL.

Pliers

Screwdriver

Wrench, open-end, $\frac{7}{16}$ -in.

Wrench, open-end, $\frac{9}{16}$ -in.

Wrench, open-end, $\frac{5}{8}$ -in.

Wrench, open-end, $\frac{3}{4}$ -in.

Wrench, open-end, $\frac{1}{16}$ -in.,
with narrow jaws

Wrench, socket, $\frac{9}{16}$ -in.

Wrench, socket, $\frac{3}{4}$ -in.

a. Remove Cylinder Head Cover Breather Line (fig. 166).

Wrench, open-end, $\frac{5}{8}$ -in.

Loosen the fitting nuts at each end of the line and remove the line.

b. Remove the Cylinder Head Cover (fig. 167).

Wrench, socket, $\frac{9}{16}$ -in.

Remove the four acorn head cap screws, steel washers and leather seals. Then lift the cylinder head cover vertically and remove it from the cyl-

ENGINE (BUDA-LANOVA DIESEL)

inder head. The gasket may come off with the cover. If it does not, use a knife to remove it from the head.

c. Drain Cooling System and Disconnect the Thermostat (fig. 166).

Screwdriver

Pliers

Drain the cooling system. Loosen the line clamps on the upper and lower hoses and slide both hoses away from the thermostat housing.

d. Remove the Air Intake Hose (fig. 170).

Screwdriver

Loosen and remove the air intake hose from the intake elbow.

e. Disconnect Cable from Air Intake Heater to Switch (fig. 170).

Pliers

Disconnect cable at heater end.

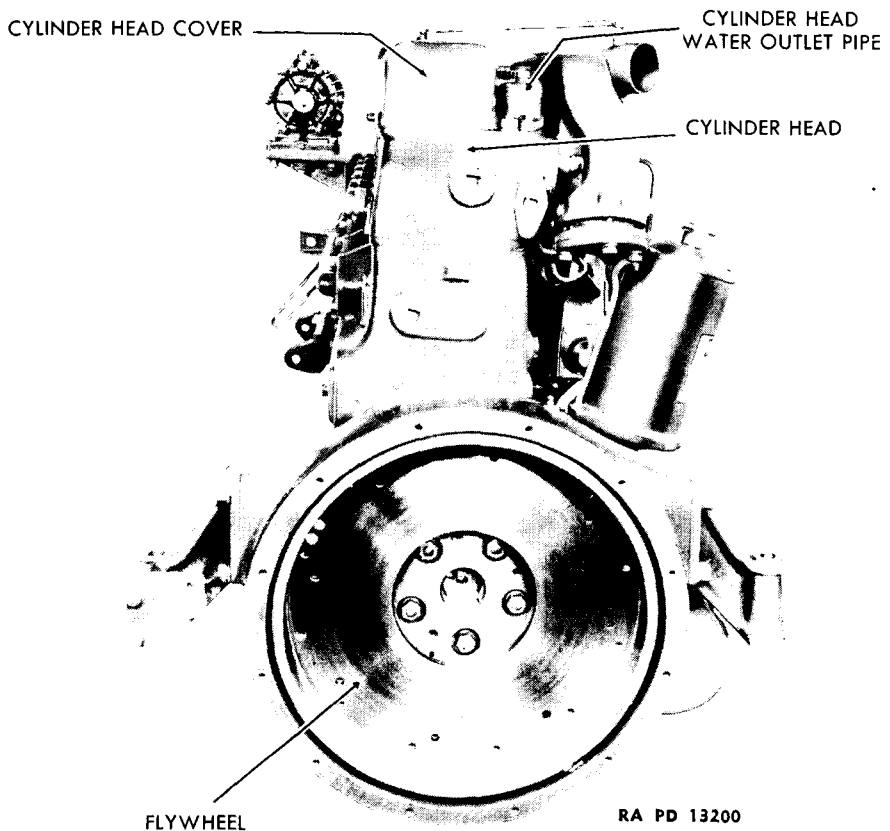

Figure 167 — Rear View of Buda Diesel Engine

SCOUT CAR M3A1

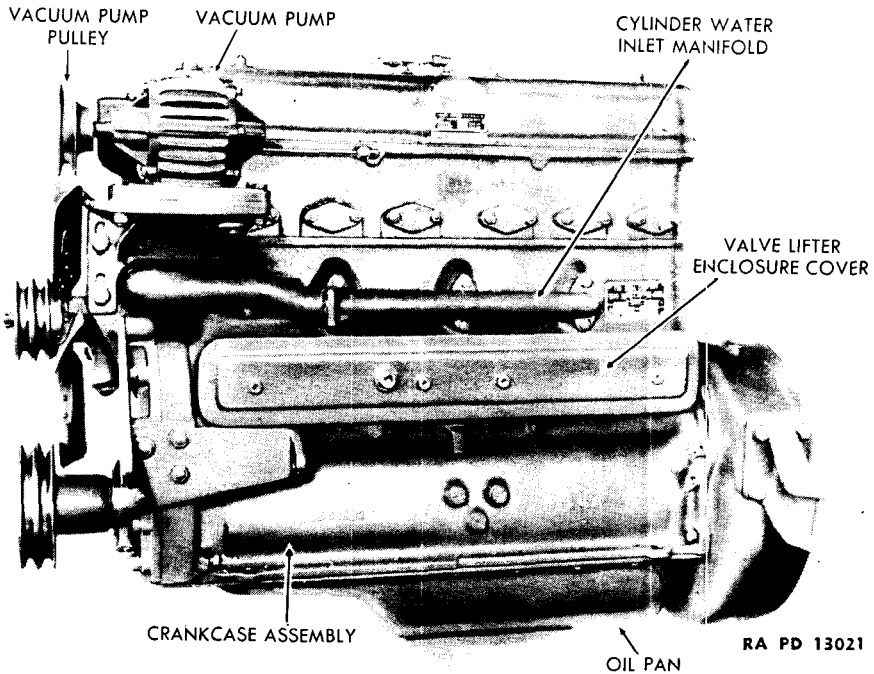

Figure 168 — Buda Diesel Engine — Left Side

f. Remove Hot Water Heater Intake Hose (fig. 170).

Screwdriver

Detach the hose from the cylinder head water outlet pipe.

g. Disconnect the Throttle Control Spring Below the Air Intake Hose (fig. 170).

Pliers

Disconnect the throttle control coil spring located below the air intake hose.

h. Remove the Water Pump to Head Elbow (fig. 166).

Screwdriver

Loosen the hose clamp and slide off the hose with the clamps.

i. Remove Oil Line from the Governor to the Head.

Wrench, open-end, $\frac{9}{16}$ -in.

Remove the cap screw from the clip on the line. Loosen the fitting nuts at each end of the line and remove the line, being careful not to alter its shape.

ENGINE (BUDA-LANOVA DIESEL)

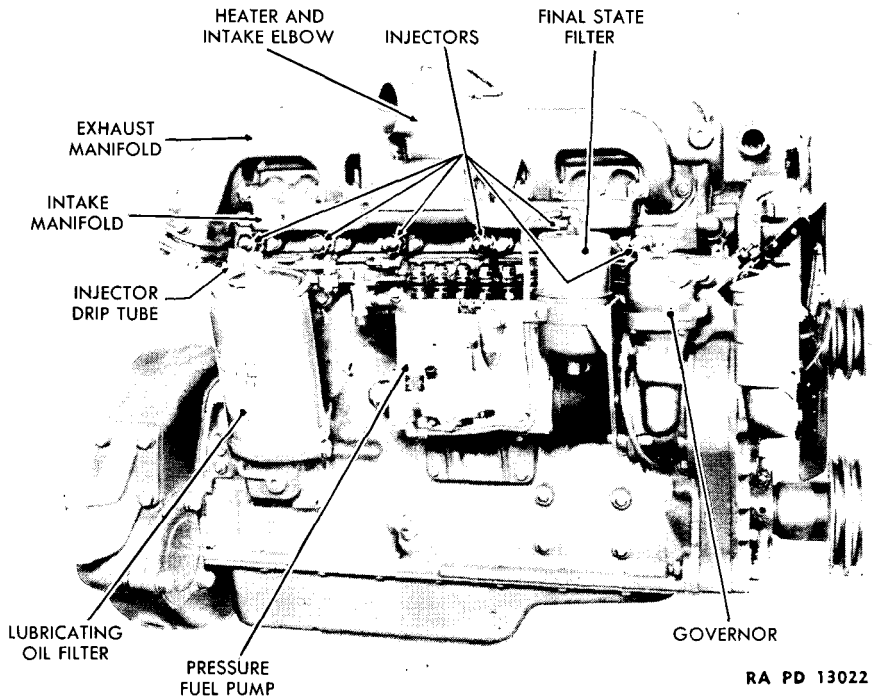

RA PD 13022

Figure 169 — Buda Diesel Engine — Right Side

j. Remove the Lines from the Fuel Pump to the Injectors (fig. 169).

Wrench, open-end, $\frac{3}{4}$ -in.

Wrench, open-end, $\frac{1}{16}$ -in.
with narrow jaws

The fuel lines are removed from the injectors, but left attached to the fuel pressure pump. Completely loosen the nuts at the injector end of the lines, using a $\frac{3}{4}$ -inch open-end wrench. Also, loosen the lines at the pressure pump end sufficiently to permit removing the lines from the injectors ($\frac{1}{16}$ -inch open-end wrench with narrow jaws). As the lines are removed from the injectors, cover the ends of the lines with paper held in place by rubber bands, to keep dirt from getting into the pressure pump.

k. Remove the Oil Line from the Front to the Rear Rocker Arm.

Wrench, open-end, $\frac{7}{16}$ -in.

Wrench, open-end, $\frac{9}{16}$ -in.

Remove the cap screw from the line clamp, using a $\frac{9}{16}$ -inch open-end wrench. Loosen the two fitting nuts on the line, using a $\frac{7}{16}$ -inch open-end wrench, and remove the line with the clip.

SCOUT CAR M3A1

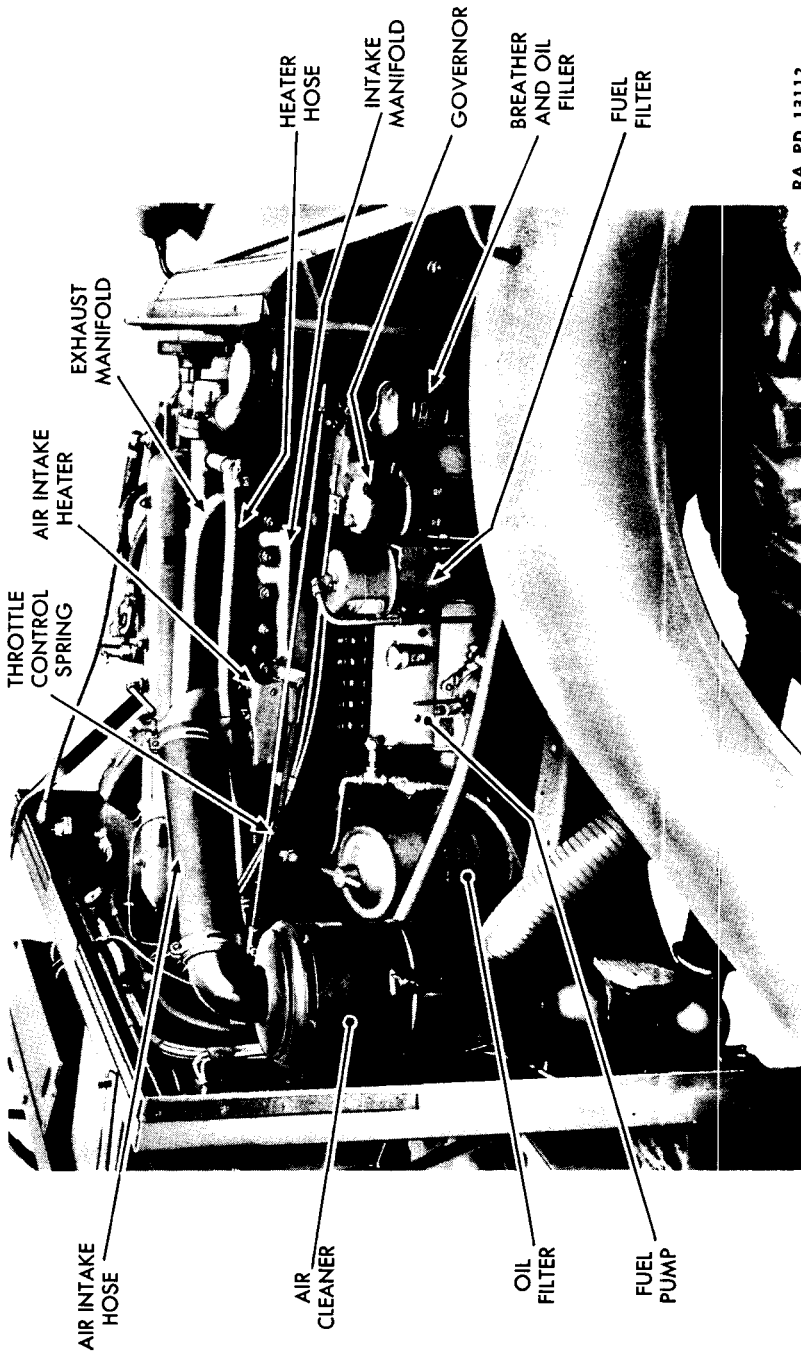

RA PD 13112

Figure 170 — Buda Diesel Engine Compartment - Right Side

ENGINE (BUDA-LANOVA DIESEL)

RA PD 13113

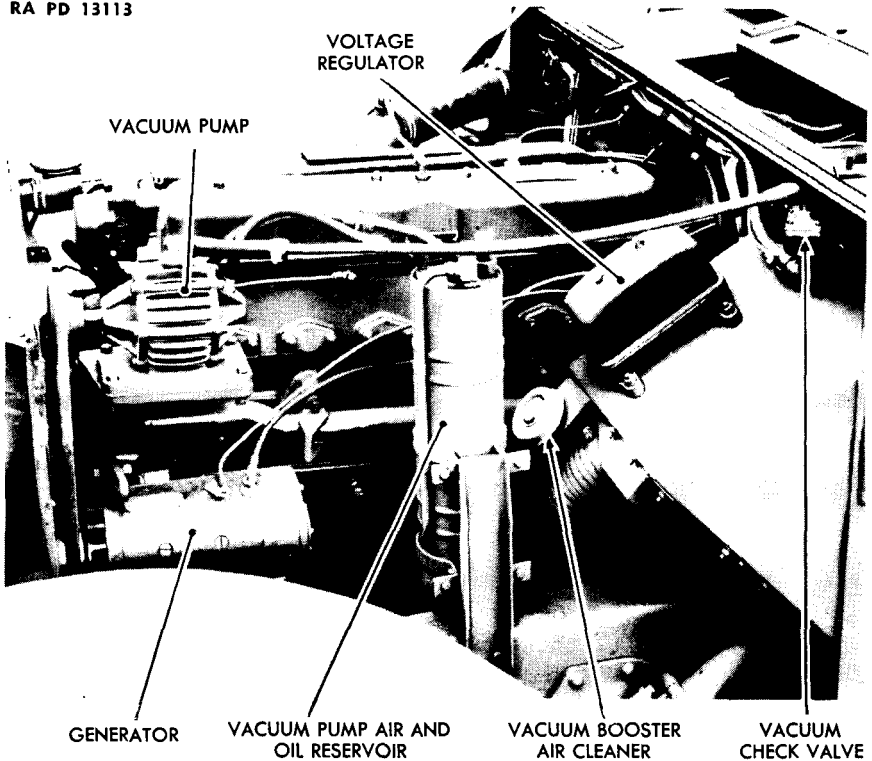

Figure 171 — Buda Diesel Engine Compartment - Left Side

l. Remove the Oil Line from the Head to the Front Rocker Arm (fig. 172).

Wrench, open-end, $\frac{7}{16}$ -in.

Loosen the two fitting nuts and remove the line.

m. Remove the Rocker Assemblies, front and rear (fig. 172).

Wrench, socket, $\frac{9}{16}$ -in.

Wrench, socket, $\frac{3}{4}$ -in.

There are front and rear rocker assemblies which are removed independently. At each rocker, two cap screws are used, making a total of six for each rocker assembly. Remove the three cap screws on one side of each assembly, using a $\frac{9}{16}$ -inch socket wrench. Remove the three cap screws and shakeproof washers on the other side of each assembly, using a $\frac{3}{4}$ -inch socket wrench. Lift each assembly straight up to remove it.

n. Remove the Push Rods. Lift the 12 push rod tubes out through the cylinder head.

SCOUT CAR M3A1

o. Remove the Cylinder Head.

Wrench, socket, $\frac{3}{4}$ -in.

In removing the cylinder head, care should be taken to loosen the cylinder head nuts evenly. Loosen each of the head nuts $\frac{1}{8}$ turn in the numerical order shown in figure 173, then loosen them another $\frac{1}{8}$ turn in the same order. The cylinder head nuts can then be removed. Slide the cylinder head off the studs. Do not hold the head by the valve springs. Remove the two head gaskets. The two head dowels should be left in the cylinder block.

166. CYLINDER HEAD INSTALLATION.

Drift, diameter brass, $\frac{1}{2}$ -in.

Hammer

Pliers

Screwdriver

Wrench, open-end, $\frac{7}{8}$ -in.

Wrench, open-end, $\frac{5}{8}$ -in.

Wrench, open-end, $\frac{3}{4}$ -in.

Wrench, open-end, $\frac{1}{8}$ -in., with narrow jaws

Wrench, socket, $\frac{9}{16}$ -in.

Wrench, socket speed, $\frac{3}{4}$ -in.

Wrench, torque

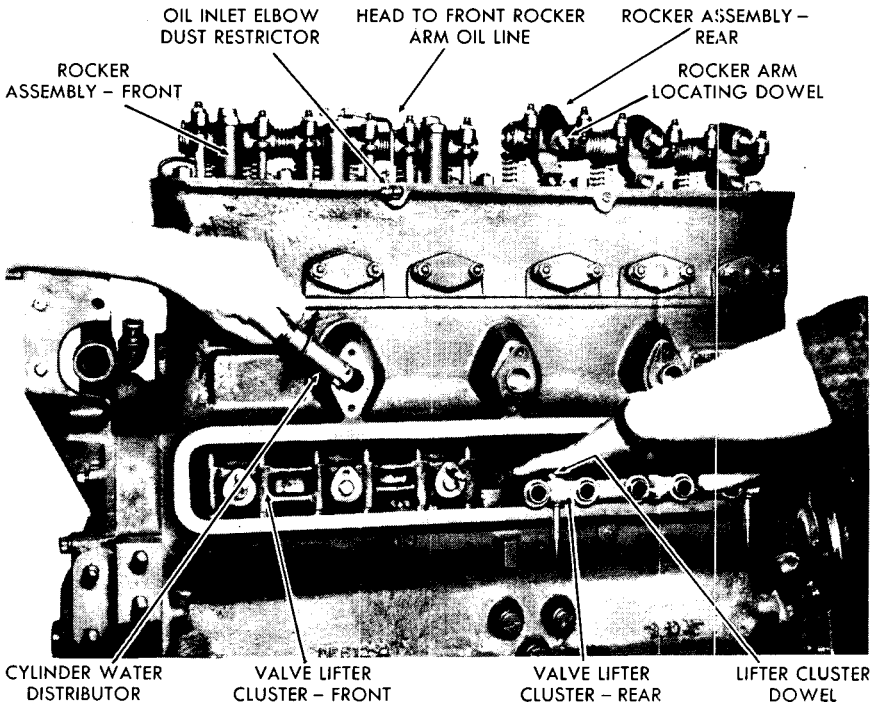

RA PD 13034

Figure 172 — Rocker Arm Assembly - (Buda Diesel)

ENGINE (BUDA-LANOVA DIESEL)**a. Install the Cylinder Head.**Drift, diameter brass, $\frac{1}{2}$ -in.Wrench, socket speed, $\frac{3}{4}$ -in.

Hammer

Wrench, torque

Using a new major head gasket, cover both sides with a light coat of OIL, engine, SAE 10, and put the gasket in place. Fit the minor gasket in the major gasket. Set the cylinder head in position on the studs, recheck the minor head gasket location with the head about one inch from the block, then push the head into place. Put a flat washer on each of the 15 head studs. Install the nuts on the studs and tighten with a speed wrench until the nuts are just snug. Tighten the nuts in the order shown in figure 173 to 30 pound-feet torque; tighten in the same order to 50 pound-feet torque; then tighten in the same order to 157 $\frac{1}{2}$ pound-feet torque.

b. Install the Push Rods. Set the 12 push rod tubes in position in the lifter.

c. Install the Rocker Assemblies (fig. 172).Wrench, $\frac{9}{16}$ -in.Wrench, $\frac{3}{4}$ -in.

Make sure there are two dowels in each rocker assembly. Install the rear rocker assembly first. This assembly has the oil elbow in the top. Put the assembly in place and insert the three large cap screws ($\frac{3}{4}$ -in. wrench) with shakeproof washers and the three smaller cap screws ($\frac{9}{16}$ -in. wrench) and lock washers. Make sure the push rods are in place before tightening the cap screws. Repeat the above procedure for the front rocker arm assembly. Be sure the clip is on the inter-rocker oil line.

d. Install the Oil Line from the Head to the Front Rocker Arm (fig. 172).

Wrench, open-end, $\frac{7}{16}$ -in.

Put the line in position and tighten the two fitting nuts.

e. Install the Oil Line from Front to Rear Rocker Arm.Wrench, open-end, $\frac{7}{16}$ -in.Wrench, socket, $\frac{9}{16}$ -in.

Put the oil line in place and tighten the fitting nuts ($\frac{7}{16}$ -in. open-end wrench). Fasten the clip under the cap screws in the rear support of the front rocker assembly ($\frac{9}{16}$ -in. socket wrench).

f. Connect the Lines to the Injectors.Wrench, open-end, $\frac{3}{4}$ -in.Wrench, open-end, $\frac{1}{16}$ -in., with narrow jaws

Make sure the fuel line clamps are in position. Remove the paper covering the ends of the lines. With the fuel lines still $\frac{1}{2}$ a turn loose at the fuel pump, set the line ends in place on the injectors and start the

SCOUT CAR M3A1

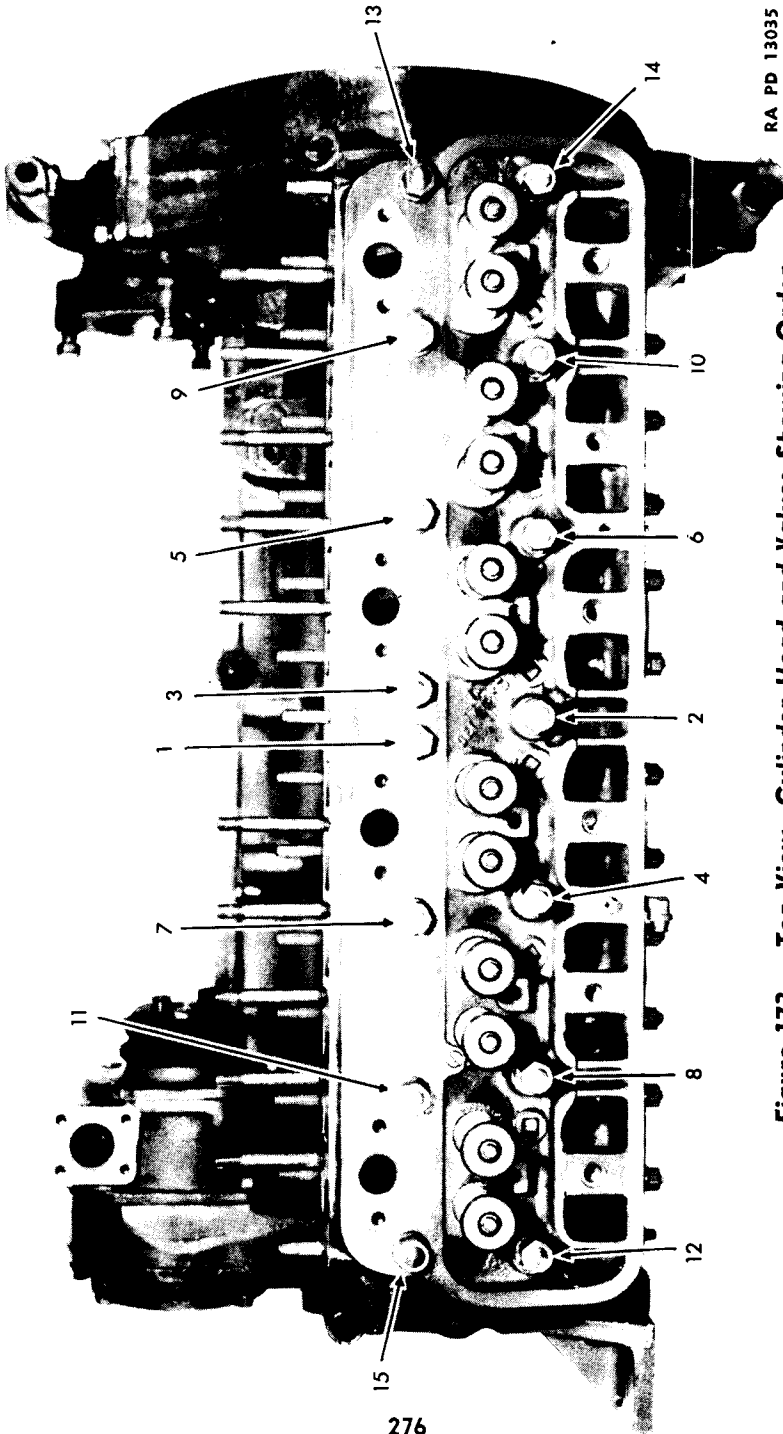

RA PD 13035

Figure 173 — Top View - Cylinder Head and Valves Showing Order of Tightening Cylinder Head Nuts - (Buda Diesel)

ENGINE (BUDA-LANOVA DIESEL)

nuts with the fingers. Then give about $\frac{1}{6}$ of a turn with the $\frac{3}{4}$ -inch open-end wrench. When the nuts are snug, they are tight enough. In a similar way, tighten the nuts at the fuel pump end of the lines, using a narrow jaw $\frac{1}{8}$ -inch open-end wrench.

g. Install Oil Line from Governor to Head.

Wrench, open-end, $\frac{9}{16}$ -in.

Set the line from the governor to the head in place, with the clamp in the line. Tighten the two fitting nuts. Fasten the oil line clip to the head with the cap screw, using the same wrench.

h. Install the Elbow from the Water Pump to the Head (fig. 166).

Screwdriver

Put the elbow in place, attaching first to the pump outlet. Be sure the two hose clamps are in place. Tighten the hose clamps.

i. Connect the Throttle Control Spring Below the Air Intake Hose (fig. 170).

Pliers

Connect the coil spring located below the air intake hose.

j. Connect Hot Water Heater Intake Hose (fig. 170).

Screwdriver

Slide the hose onto the cylinder head water outlet pipe connection, and tighten the clamp.

k. Connect the Air Intake Hose (fig. 170).

Screwdriver

Slide the air intake hose onto the intake elbow, and tighten the hose clamp.

l. Connect the Cable from Switch to Air Intake Heater.

Pliers

Connect the cable from the switch at the air intake heater.

m. Connect the Thermostat (fig. 166).

Screwdriver

Slide both hoses onto the thermostat housing; place the clamps in position, and tighten.

n. Install the Cylinder Head Cover.

Wrench, socket, $\frac{9}{16}$ -in.

Set the graphite-covered gasket in place. Set the cover in place. Install a steel washer and a leather washer on each of the acorn head cap screws, and tighten to a snug fit.

SCOUT CAR M3A1

- o. Install the Cylinder Head Cover Breather Line (fig. 166).**
Wrench, open-end, $\frac{5}{8}$ -in.
Set the line in place and tighten the fitting nuts at each end.
- p. Fill the Cooling System with Water or Antifreeze.**

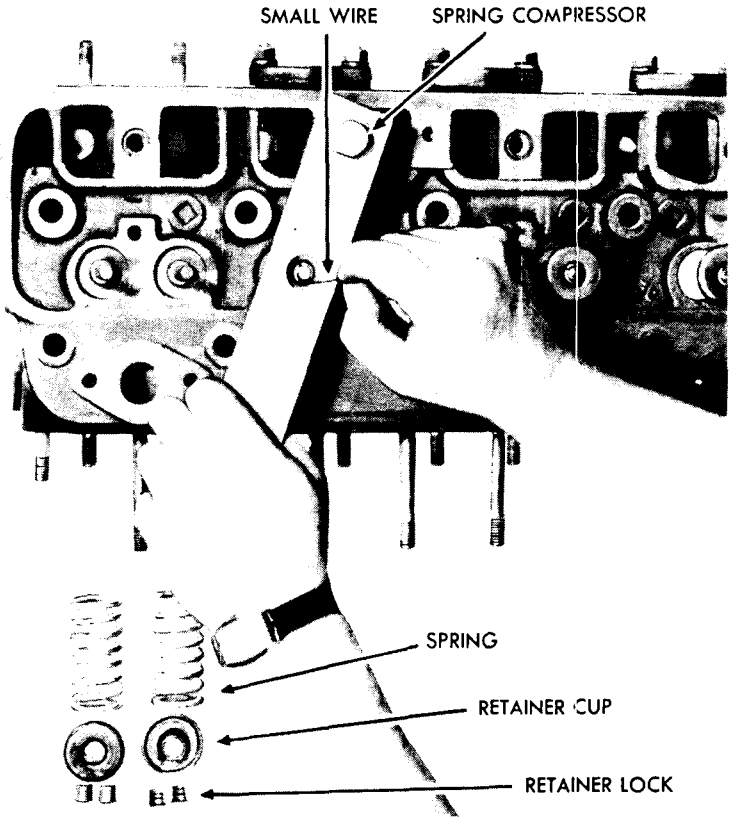

RA PD 11684

Figure 174 — Valve Removal - (Buda Diesel)

167. REMOVAL AND INSTALLATION OF VALVES.

Screw, cap, $\frac{1}{2}$ -in.

Wire, small

Stock, flat piece, $\frac{1}{4}$ -in.

- a. Remove the Cylinder Head.** See paragraph 165, this section.

ENGINE (BUDA-LANOVA DIESEL)

b. Remove the Valves (fig. 174).

Screw, cap, $\frac{1}{2}$ -in.

Wire, small

Stock, flat piece, $\frac{1}{4}$ -in.

Take a flat piece of $\frac{1}{4}$ -inch stock and make a spring compression tool as shown in figure 174. One of the $\frac{1}{2}$ -inch cap screws used for the rocker arms can be used with this tool to compress the springs. With the spring compressed, use a small wire to pick the two sections of the retainer locks from the retainer cups. Then release the spring and remove the retainer cups and the spring. Remove the valve stem retainer. Repeat this procedure for each valve. The valves can be removed from the other side of the head.

c. For Valve Grinding Instructions, see paragraph 142.

d. **Valve Installation** (fig. 174). Install the valve, valve stem retainers, springs, and retainer cups in that order. Install the retainer locks, making sure that the small diameter is toward the head so that lock will fit the taper in the retainer cup.

e. Install Cylinder Head. Refer to paragraph 166.

168. CLEANING CARBON.

Refer to paragraph 156.

169. FLYWHEEL MARKING (fig. 175).

The flywheel is marked "1 FPI," indicating top dead center for No. 1 piston, and is visible through the flywheel timing hole which is located in the flywheel housing, in front of the bell housing.

170. REMOVAL AND INSTALLATION OF MANIFOLD.

Screwdriver

Wrench, open-end, $\frac{5}{8}$ -in.

Wrench, open-end, $\frac{9}{16}$ -in.

Wrench, socket, $\frac{1}{2}$ -in.

Wrench, socket, $\frac{9}{16}$ -in.

a. Removal.

(1) **REMOVE THE CYLINDER HEAD BREATHER COVER LINE** (fig. 166).

Wrench, open-end, $\frac{5}{8}$ -in.

Loosen the fitting nuts at each end of the line, and remove the line.

(2) **DRAIN COOLING SYSTEM AND REMOVE THE HOT WATER HEATER INTAKE HOSE** (fig. 170).

Pliers

Screwdriver

Drain cooling system (if not previously emptied). Detach the hose from the cylinder head water outlet pipe.

SCOUT CAR M3A1

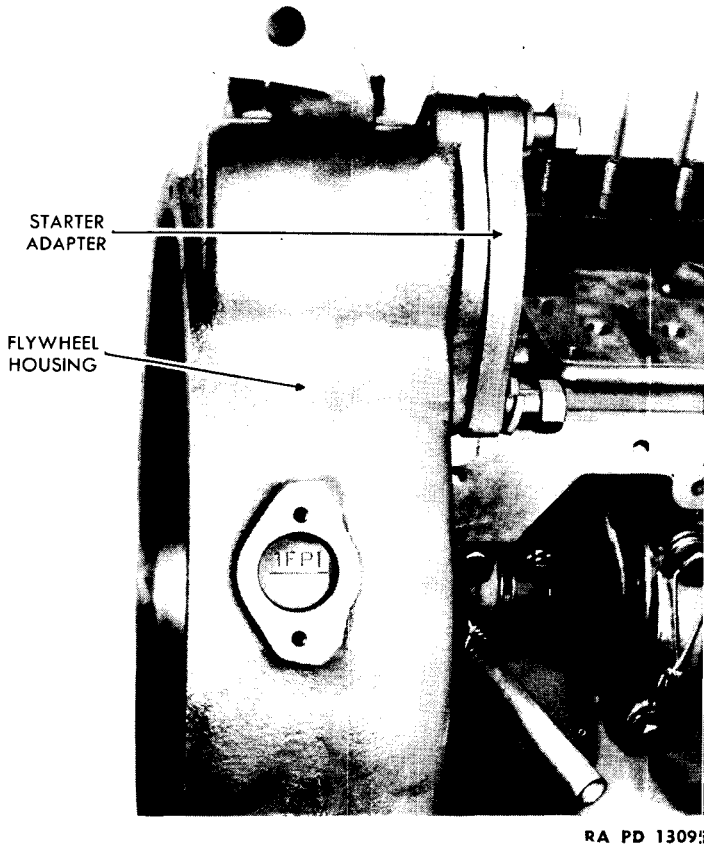

Figure 175 — Flywheel Marking - (Buda Diesel)

- (3) REMOVE THE AIR INTAKE HOSE (fig. 170).

Screwdriver

Loosen the clamping screw and remove the air intake hose from the intake elbow.

- (4) REMOVE THE AIR INTAKE ELBOW AND HEATER (fig. 169).

Wrench, socket, $\frac{9}{16}$ -in.

Disconnect cable from air intake heater to switch. Remove the two cap screws which hold the heater and elbow to the intake manifold. Lift off the heater and intake elbow. The brackets, which hold the coil spring and cables located below the air intake hose, will come away when the two cap screws are removed.

ENGINE (BUDA-LANOVA DIESEL)

(5) REMOVE THE INTAKE MANIFOLD SHIELD.

Wrench, socket, $\frac{1}{2}$ -in.

Remove the two cap screws and spacers. Lift off the shield.

(6) DISCONNECT THE EXHAUST PIPE FROM THE EXHAUST MANIFOLD. Disconnect the exhaust pipe from the exhaust manifold at the flange.

(7) REMOVE THE MANIFOLDS (fig. 170).

Wrench, open-end, $\frac{9}{16}$ -in.

Wrench, socket, $\frac{9}{16}$ -in.

Loosen the 13 nuts on the manifolds ($\frac{9}{16}$ -in. wrench) only $\frac{1}{8}$ turn each. A socket wrench can be used on all, except the nut back of the exhaust elbow which requires an open-end wrench. Remove the 10 nuts and spacers which hold the intake manifold. Slide the intake manifold out from the block and remove it. Remove the center and front end nuts ($\frac{9}{16}$ -in. wrench) and spacers from the exhaust manifold. Use a $\frac{9}{16}$ -inch open-end wrench to remove the nut and washer located in back of the exhaust elbow. Then slide the exhaust manifold out and remove it. Remove the gasket.

b. Installation.

Screwdriver

Wrench, socket, $\frac{1}{2}$ -in.

Wrench, open-end, $\frac{9}{16}$ -in.

Wrench, socket, $\frac{9}{16}$ -in.

Wrench, open-end, $\frac{5}{8}$ -in.

(1) INSTALL THE MANIFOLDS (fig. 170).

Wrench, open-end, $\frac{9}{16}$ -in.

Wrench, socket, $\frac{9}{16}$ -in.

Cover the manifold gasket with light engine oil and set it in place. Set the exhaust manifold in place. Put the washers and nuts on the two end and center studs, using a $\frac{9}{16}$ -inch open-end wrench. Screw the nut back of the elbow down against the washer, but do not tighten. Set the screen assembly on the intake manifold, sticking it in place with oil. Set the intake manifold in place, with the screen covering the inlet opening. Put the 10 washers in place and start all the nuts onto the studs. Tighten all the nuts uniformly, using the $\frac{9}{16}$ -in. wrenches.

(2) CONNECT THE EXHAUST PIPE. Connect the exhaust pipe to the exhaust manifold at the flange.

(3) INSTALL THE SHIELD FOR THE INTAKE MANIFOLD.

Wrench, socket, $\frac{1}{2}$ -in.

Put the intake shield in place with two $\frac{1}{4}$ -inch spacers and two cap screws. Tighten the cap screws.

(4) INSTALL THE AIR INTAKE ELBOW AND HEATER (fig. 169).

Wrench, socket, $\frac{9}{16}$ -in.

Set the heater and elbow in place, with the inlet toward the rear of the engine. Place the brackets, which hold the coil spring and cables

SCOUT CAR M3A1

(located below the air intake hose), in position and insert and tighten the two cap screws. Tighten the cap screws. Attach cable from switch.

(5) **INSTALL THE AIR INTAKE HOSE** (fig. 170).

Screwdriver

Slide the air intake hose onto the intake elbow and tighten the hose clamp.

(6) **CONNECT THE HOT WATER HEATER INTAKE HOSE** (fig. 170).

Screwdriver

Slide the hose onto the cylinder head water outlet pipe connection, and tighten the clamp.

(7) **INSTALL THE LINE FOR THE CYLINDER HEAD BREATHER COVER** (fig. 166).

Wrench, open-end, $\frac{5}{8}$ -in.

Set the line in place and tighten the fitting nuts at each end.

(8) **FILL COOLING SYSTEM WITH WATER OR ANTIFREEZE.**

171. REMOVAL AND INSTALLATION OF OIL PAN.

NOTE: Drain engine oil and replace plug.

OIL, engine, seasonal grade

Wrench, socket, $\frac{9}{16}$ -in.

Shellac

a. Removal.

Wrench, socket, $\frac{9}{16}$ -in.

Loosen all the cap screws $\frac{1}{8}$ turn each, and then remove them. The gasket is in four sections. Remove these from the pan.

b. Installation.

OIL, engine, seasonal grade

Wrench, socket, $\frac{9}{16}$ -in.

Shellac

After the oil pan is thoroughly clean, shellac new oil pan gaskets in place on the oil pan. Put a light coat of engine oil on the gasket surface of the crankcase. Set the oil pan in place and start each of the 24 cap screws by hand, tighten uniformly. Make sure the oil drain plug is in place in the oil pan.

c. Refill Crankcase with Engine Oil.

172. OIL PUMP.

The oil is circulated by a gear-type oil pump driven by a fork and pin directly from the rear end of the camshaft, without any intermediate driving gears. The oil is drawn from the pan through a suction-type screen and suction line to the pump. The oil pump assembly fits in a

ENGINE (BUDA-LANOVA DIESEL)

recess in the flywheel enclosure of the crankcase and is held in place by four cap screws. The connection to the pressure and suction passages in the crankcase is made by hollow dowels and sealed against oil leaks by copper asbestos gaskets. The oil pump is designed to retain its prime after the engine is stopped, as long as it remains in a normal position, making priming unnecessary.

173. ENGINE REMOVAL.

Chain, hoist	Wrench, open-end, $\frac{9}{16}$ -in.
Extension, ratchet	Wrench, open-end, $\frac{5}{8}$ -in.
Hoist	Wrench, open-end, $\frac{3}{4}$ -in.
Pail	Wrench, open-end, $\frac{7}{8}$ -in.
Pliers	Wrench, open-end, $1\frac{5}{8}$ -in.
Rope, length of	Wrench, socket, $\frac{9}{16}$ -in.
Screwdriver, heavy-duty	Wrench, socket, $\frac{3}{4}$ -in.
Screwdriver, large	Wrench, socket, $1\frac{5}{8}$ -in.
Wood, blocks	Wrench, socket, $\frac{7}{16}$ -in., thin-walled
Wrench, open-end, $\frac{3}{8}$ -in.	Wrench, socket, $\frac{7}{8}$ -in., with universal attachment
Wrench, open-end, $\frac{7}{16}$ -in.	
Wrench, open-end, $\frac{1}{2}$ -in.	

a. Drain Radiator.

Pail Pliers

Open drain cocks on radiator and on the right rear side of the block, and drain water into pail, or on ground.

b. Remove Hood.

Hoist Screwdriver, large
Rope, length of Wrench, open-end, $\frac{9}{16}$ -in.

Remove three elastic stop nuts and bolts at rear of center panel of hood. Remove nut and bolt on inside of shutter frame, near the top, on each side of frame. Use rope and hoist to lift off hood, with top of shutter frame left on hood. Hood can also be slipped over front of car by three men.

c. Remove Shutter Assembly.

Hoist, chain Wrench, box, $\frac{9}{16}$ -in.
Screwdriver, heavy-duty Wrench, open-end, $\frac{1}{2}$ -in.

Remove bolts and nuts that hold the shutter frame to engine side-armor plates. Disconnect shutter control on lower right side of radiator. Lift shutter frame straight up, and out.

d. Remove Radiator Hose Connections.

Screwdriver

Loosen clamps that hold the inlet and outlet radiator hoses, and pull hoses loose from radiator.

SCOUT CAR M3A1**e. Remove Radiator.**

Chain, hoist

Wrench, socket, $\frac{7}{8}$ -in., with
universal attachmentWrench, socket, $\frac{3}{4}$ -in.

Disconnect radiator from cross member by removing holding stud nuts, springs, washers and pads. Then disconnect stay rods at frame by removing nuts from stay rod bolts underneath car, on the bottom side of the top frame flange. Remove radiator assembly from car by lifting up and slightly forward.

f. Remove Heater Inlet and Return Hoses.

Screwdriver

Loosen clamp that holds the inlet hose, and pull off hose. Disconnect flared tube connection on the return line at the heater, and remove hose.

g. Disconnect Batteries.Wrench, open-end, $\frac{9}{16}$ -in.

Remove cap screws and lock washers that hold the battery compartment covers. Loosen nuts clamping cables to battery terminals, and pull cables off terminals. Always pull off negative cable first. Tape cable terminals.

h. Remove Air Intake Pipe.

Screwdriver

Loosen the clamps at the Venturi and at the air cleaner. Remove the pipe.

i. Disconnect Throttle Controls.

Screwdriver

Wrench, open-end, $\frac{7}{16}$ -in.

Use a screwdriver to remove the screw that holds the hand-operated throttle wire at the Venturi. Remove the nut that holds the foot-operated throttle rod at the Venturi lever. Detach the wire and rod.

j. Disconnect Fuel Injector Shut-Off Wire.

Screwdriver

Wrench, open-end, $\frac{3}{8}$ -in.

Disconnect the shut-off wire at the pump.

k. Disconnect Governor Control Wire.

Screwdriver

Wrench, open-end, $\frac{3}{8}$ -in.

Disconnect the control wire at the governor.

l. Disconnect Lines to Fuel Transfer Pump.Wrench, open-end, $\frac{5}{8}$ -in.Wrench, open-end, $\frac{3}{4}$ -in.

Using a $\frac{3}{4}$ -inch open-end wrench, disconnect the main line from the fuel tank to the fuel transfer pump. Then, use a $\frac{5}{8}$ -inch open-end wrench to disconnect the return line on the other side of the pump.

ENGINE (BUDA-LANOVA DIESEL)

m. Disconnect the Filter Lines.

Wrench, open-end, $\frac{3}{4}$ -in.

Disconnect the fuel line from the pump to the filter at the pump end, using a $\frac{3}{4}$ -inch open-end wrench. Then, disconnect the line from the filter to the injector by removing the plug and screen assembly.

n. Disconnect the Generator Wires.

Pliers	Wrench, socket, $\frac{7}{16}$ -in., thin-walled
Screwdriver	Wrench, socket, $\frac{9}{16}$ -in., with ratchet extension
Wrench, open-end, $\frac{5}{8}$ -in.	

Using pliers, remove the condenser and wire shielding nut. Use a $\frac{9}{16}$ -inch socket wrench, with ratchet extension, to remove the armature terminal nut. Remove the plug from the field terminal, using a screwdriver. Then, use a $\frac{5}{8}$ -inch open-end wrench to remove the wire shielding nut. Use a thin-walled $\frac{7}{16}$ -inch socket wrench to remove the wire terminal nut. Remove the stove bolt that clamps the armature and field wires to the thermostat housing.

o. Disconnect Venturi Heater Wire.

Wrench, open-end, $\frac{7}{16}$ -in.

Use a $\frac{7}{16}$ -inch open-end wrench to disconnect the wire from the Venturi intake heater unit.

p. Disconnect the Heat Indicator Unit.

Wrench, open-end, $\frac{5}{8}$ -in.

Disconnect the heat indicator unit from the right top side of the cylinder head water outlet.

q. Remove the Left Air Funnel Assembly.

Screwdriver	Wrench, open-end, $\frac{9}{16}$ -in.
-------------	---------------------------------------

Loosen clamp that holds funnel assembly to ventilator box. Remove nut, cap screw and lock washer that hold funnel support clamp to bracket, and lower assembly.

r. Disconnect Vacuum Pump Lines.

Screwdriver	Wrench, open-end, $\frac{5}{8}$ -in.
Wrench, open-end, $\frac{7}{16}$ -in.	Wrench, open-end, $\frac{7}{8}$ -in.

Remove the vacuum line and hose from the pump to the screen and check valve on the dash, using a $\frac{7}{8}$ -inch open-end wrench, and screwdriver. Disconnect the vacuum pump lines, to oil and air reservoir, using $\frac{7}{8}$ -inch and $\frac{5}{8}$ -inch open-end wrenches. Then remove the vacuum pump oil and exhaust tank, using a screwdriver and a $\frac{7}{16}$ -inch open-end wrench to remove the stove bolts from the brackets.

SCOUT CAR M3A1**s. Disconnect the Oil Gage Line.**Wrench, open-end, $\frac{7}{16}$ -in.Wrench, open-end, $\frac{1}{2}$ -in.

Disconnect the oil filter to dash gage line at the union.

t. Disconnect the Exhaust Manifold.Wrench, open-end, $\frac{3}{4}$ -in.Wrench, open-end, $\frac{7}{8}$ -in.

Remove the seven self-tapping screws that hold the exhaust pipe clearance dash cover to the dash. Disconnect the exhaust manifold from the exhaust pipes at the rear of the engine by removing the nuts and bolts from the mounting flange.

u. Remove the Starter.Wrench, open-end, $\frac{7}{16}$ -in.Wrench, open-end, $\frac{7}{8}$ -in.Wrench, open-end, $\frac{3}{4}$ -in.

Remove the starter terminals from the starter, using a $\frac{3}{4}$ -inch open-end wrench on the two large terminals, and a $\frac{7}{16}$ -inch open-end wrench on the small terminal. Remove the starter cable from the block. Then remove the starter by taking out the three cap screws with a $\frac{7}{8}$ -inch open-end wrench.

v. Disconnect Brake Vacuum Booster.

Pliers

Disconnect the brake vacuum booster from the bracket by removing the clevis pin from the clevis on the rear of the booster, using pliers.

w. Remove Floor Plate over Transmission.

Screwdriver

Unscrew and remove the transfer case shift lever ball. Remove seven machine screws that hold center floor plate, and remove the plate. NOTE: Cover is easily removed by first lifting front section over extended section of dash, and then lifting rear section.

x. Disconnect Propeller Shaft.Wrench, open-end, $\frac{5}{8}$ -in. (two)

Remove four nuts, lock washers and bolts that hold propeller shaft to the companion flange on transmission, and separate propeller shaft from companion flange.

y. Remove Clutch Release Bearing Outer Oil Tube.Wrench, open-end, $\frac{7}{16}$ -in.Wrench, socket, $\frac{9}{16}$ -in.

Unscrew inverted flared tube nut from elbow on bell housing ($\frac{7}{16}$ -in. open-end wrench). Remove cap screw and lock washer holding oil tube clip to bell housing ($\frac{9}{16}$ -in. socket wrench), and lift out oil tube.

ENGINE (BUDA-LANOVA DIESEL)

z. Remove Transfer Case Shift Lever.

Wrench, socket, $\frac{9}{16}$ -in.

Remove two cap screws and lock washers securing transfer case shift lever to transmission, and lift assembly out of the way.

aa. Remove Hand Brake Lever.

Screwdriver

Wrench, socket, $\frac{9}{16}$ -in.

Release hand brake and remove the two nuts and lock washers that secure the hand brake lever assembly to transmission ($\frac{9}{16}$ -in. socket wrench). Pry hand brake lever assembly away from studs on transmission (screwdriver) and allow it to drop down out of the way.

bb. Remove Transmission Shift Lever.

Wrench, socket, $\frac{9}{16}$ -in.

Remove four cap screws and lock washers, and lift off shift lever and top assembly. Cover opening to prevent dirt from entering transmission.

cc. Remove Clutch Release Pedal Shaft Lever.

Hammer

Wrench, open-end, $\frac{9}{16}$. (two)

Pliers

Remove cotter pin and pull out clevis pin at clutch release pedal shaft lever. Loosen nut on cap screw clamping lever to shaft ($\frac{9}{16}$ -inch open-end wrenches (two)), and drive off lever. Remove lubricating fitting from shaft support to prevent it from breaking off when removing engine ($\frac{7}{16}$ -inch open-end wrench).

dd. Prepare Engine for Removal.

Hoist

Rope, Manila, $\frac{3}{4}$ -in. (at least 14 feet)

Tie rope around engine in a figure eight. Place hoist hook in balanced place of rope (slightly to rear of engine) and remove slack in rope by raising hook.

ee. Disconnect Engine Supports.

Handle, ratchet

Wrench, open-end, $\frac{1}{2}$ -in.

Pliers

Wrench, socket, $\frac{3}{4}$ -in.

Wrench, open-end, $\frac{3}{4}$ -in.

Wrench, socket, $\frac{1}{2}$ -in.

Remove cotter pins from castellated nuts at rear support bolts and remove the nuts, bolts, washers, and right support spring. Remove four nuts, lock washers and cap screws from the front engine supports (fig. 126).

ff. Remove Engine Assembly. Lift engine until free of supports and move straight forward until transmission is clear of dash. **NOTE:** Use care in guiding engine out to prevent clutch lever shaft from catch-

SCOUT CAR M3A1

ing on engine support brackets. Lift engine, with transmission, out of vehicle and place in stand, or on blocks.

174. ENGINE INSTALLATION.

Chain, hoist	Wrench, open-end, $\frac{1}{2}$ -in.
Crank	Wrench, open-end, $\frac{9}{16}$ -in. (two)
Extension, ratchet	Wrench, open-end, $\frac{5}{8}$ -in.
Hammer	Wrench, open-end, $\frac{3}{4}$ -in.
Pail (or hose)	Wrench, open-end, $\frac{7}{8}$ -in.
Pliers	Wrench, open-end, $1\frac{5}{8}$ -in.
Rope, manila, length of $\frac{3}{4}$ -in.	Wrench, socket, $\frac{9}{16}$ -in.
Screwdriver	Wrench, socket, $\frac{3}{4}$ -in.
Screwdriver, heavy-duty	Wrench, socket, $1\frac{5}{8}$ -in.
Wrench, box, $\frac{9}{16}$ -in.	Wrench, socket, $\frac{7}{16}$ -in., thin-walled
Wrench, open-end, $\frac{3}{8}$ -in.	Wrench, socket, $\frac{7}{8}$ -in., with universal attachment
Wrench, open-end, $\frac{7}{16}$ -in.	

a. Place Engine Assembly in Vehicle.

Hoist

Rope, Manila, $\frac{3}{4}$ -in.

With transmission mounted on engine, place rope around the assembly in a figure eight. Place hoist hook in balanced position on rope and raise engine assembly high enough to clear front frame cross member. Carefully guide engine assembly into position on rear engine support brackets. NOTE: Place pads on support brackets before engine is finally positioned.

b. Bolt Engine Assembly to Frame.

Handle, ratchet

Wrench, open-end, $1\frac{5}{8}$ -in.

Pliers

Wrench, socket, $\frac{3}{4}$ -in.

Wrench, open-end, $\frac{3}{4}$ -in.

Wrench, socket, $1\frac{5}{8}$ -in.

Secure rear engine supports with plain washers, bolt and castle nut on left side ($1\frac{5}{8}$ -in. socket wrench and $1\frac{5}{8}$ -in. open-end wrench) and plain washers, bolt, spring and castle nut on right side ($\frac{3}{4}$ -in. socket wrench and $\frac{3}{4}$ -in. open-end wrench). Install cotter pins in castle nuts and lock pins (pliers). Bolt front trunnion to frame with four cap screws, lock washers and nuts ($\frac{3}{4}$ -in. socket wrench and $\frac{3}{4}$ -in. open-end wrench).

c. Install Transmission Shift Lever Assembly.

Wrench, socket, $\frac{9}{16}$ -in.

Place lever and cover assembly over transmission cover, guiding lever into position on lugs in transmission cover. Secure lever and cover assembly with four cap screws and lock washers.

ENGINE (BUDA-LANOVA DIESEL)

d. Install Clutch Release Bearing Outer Oil Tube.

Wrench, open-end, $\frac{7}{16}$ -in.

Wrench, socket, $\frac{9}{16}$ -in.

Place oil tube in position and screw inverted flared tube nut into elbow on bell housing ($\frac{7}{16}$ -in. open-end wrench). Secure tube clip to bell housing with cap screw and lock washer.

e. Install Transfer Case Shift Lever.

Wrench, socket, $\frac{9}{16}$ -in.

Mount transfer case shift lever assembly on transmission cover and secure with two cap screws and lock washers.

f. Install Hand Brake Lever.

Wrench, socket, $\frac{9}{16}$ -in.

Slip hand brake lever assembly over studs on transmission and secure with two nuts and lock washers.

g. Connect Propeller Shaft.

Wrench, open-end, $\frac{5}{8}$ -in. (two)

Connect propeller shaft to transmission companion flange with four cap screws, lock washers and nuts.

h. Install Clutch Release Shaft Lever.

Hammer

Wrench, open-end, $\frac{9}{16}$ -in. (two)

Pliers

With Woodruff key in position on shaft, replace lever and secure with cap screw, nut and lock washer ($\frac{9}{16}$ -in. open-end wrenches (two)). Connect clevis to lever with clevis pin and lock clevis pin with cotter pin. Check for proper travel of clutch pedal (par. 72).

i. Replace Floor Plate over Transmission.

Screwdriver

Place floor plate in position over transmission and secure with seven machine screws.

j. Attach Brake Vacuum Booster.

Pliers

Attach brake vacuum booster to bracket by inserting clevis pin in clevis, at rear of booster.

k. Install the Starter.

Wrench, open-end, $\frac{7}{8}$ -in.

Wrench, open-end, $\frac{7}{8}$ -in.

Wrench, open-end, $\frac{3}{4}$ -in.

Place the starter in position and install the three cap screws that hold the starter in place. Use a $\frac{7}{8}$ -inch open-end wrench to tighten the cap screws. Then connect the starter terminals to the starter. Use a $\frac{7}{16}$ -inch

SCOUT CAR M3A1

open-end wrench to attach the small terminal, and a 3/4-inch open-end wrench to tighten the two large terminals.

l. Connect the Exhaust Manifold.

Wrench, open-end, 3/4-in.

Wrench, open-end, 7/8-in.

Install a new gasket between the exhaust manifold and the exhaust pipe flanges. Insert and tighten the bolts and nuts. Place the exhaust pipe clearance dash cover on the dashboard, and install the seven self-tapping screws.

m. Connect the Oil Gage Line.

Wrench, open-end, 7/8-in.

Wrench, open-end, 1/2-in.

Join the oil filter to the dash gage line at the union, and tighten.

n. Connect Vacuum Pump Lines.

Screwdriver

Wrench, open-end, 5/8-in.

Wrench, open-end, 7/8-in.

Wrench, open-end, 7/8-in.

Hold the vacuum pump oil and exhaust tank in position against the mounting bracket, and insert the stove bolts. Use a screwdriver and a 7/8-inch open-end wrench to tighten the bolts. Install the vacuum line and hose from the pump to the screen and check valve on the dash (7/8-in. open-end wrench and screwdriver). Connect the other vacuum pump lines (7/8-in. and 5/8-in. open-end wrenches).

o. Install the Left Air Funnel Assembly.

Screwdriver

Wrench, open-end, 9/16-in.

Place the funnel assembly in position at ventilator box inlet, and tighten clamp. Insert and tighten the cap screw, lock washer and nut that hold funnel support clamp to bracket.

p. Connect the Heat Indicator Unit.

Wrench, open-end, 5/8-in.

Connect the heat indicator unit to the water jacket at the right top side of the cylinder head water outlet.

q. Connect the Venturi Heater Wire.

Wrench, open-end, 7/8-in.

Connect the wire to the Venturi (intake) heater unit.

r. Connect the Generator Wires.

Pliers

Wrench, socket, 7/8-in.

Screwdriver

thin-walled

Wrench, open-end, 5/8-in.

Wrench, socket, 9/16-in., with ratchet extension

Place the armature and field wires in position at the thermostat housing, and insert and tighten the stove bolt that clamps them to the

ENGINE (BUDA-LANOVA DIESEL)

housing. Install the field terminal cable and, using a thin-walled $\frac{7}{16}$ -inch socket wrench, install the field terminal nut. Install the wire shielding nut, using a $\frac{5}{8}$ -inch open-end wrench. Then, using a screwdriver, install the plug on the field terminal. Install the armature terminal cable and the armature terminal nut, using a $\frac{9}{16}$ -inch socket wrench with ratchet. Then install the condenser and wire shielding nut, using pliers.

s. Connect the Fuel Filter Lines.

Wrench, open-end, $\frac{3}{4}$ -in.

Connect the line from the filter to the injector by attaching the plug and screen assembly. Connect the fuel line from the pump to the filter at the pump end, using a $\frac{3}{4}$ -inch open-end wrench.

t. Connect Lines to Fuel Transfer Pump.

Wrench, open-end, $\frac{5}{8}$ -in.

Wrench, open-end, $\frac{3}{4}$ -in.

Connect the main line from the fuel tank to the fuel transfer pump, using a $\frac{3}{4}$ -inch open-end wrench. Connect the fuel return line on the other side of the pump, using a $\frac{5}{8}$ -inch open-end wrench.

u. Connect Governor Control Wire.

Screwdriver

Wrench, open-end, $\frac{3}{8}$ -in.

Connect the control wire at the governor.

v. Connect Fuel Injector Shut-Off Wire.

Screwdriver

Wrench, open-end, $\frac{3}{8}$ -in.

Connect the shut-off wire at the pump.

w. Connect the Throttle Controls.

Screwdriver

Wrench, open-end, $\frac{7}{16}$ -in.

Put the throttle wire and rod in place. Using a screwdriver, install the screw that holds the hand-operated throttle wire at the Venturi. Then, install the nut that holds the foot-operated throttle rod at the Venturi lever.

x. Install Air Intake Pipe.

Screwdriver

Place the air intake pipe in position, and tighten the clamps at the Venturi and at the air cleaner.

y. Connect the Batteries.

Wrench, open-end, $\frac{9}{16}$ -in.

Remove tape from battery cable terminals. Attach the positive cable first, then attach the negative cable, and tighten the nuts. Put on the battery compartment covers, and insert and tighten the cap screws and lock washers.

SCOUT CAR M3A1**z. Install Heater Inlet and Return Hoses.**

Screwdriver

Connect the flared tube connector on the return line at the heater. Install the inlet hose, and tighten the clamp.

aa. Install Radiator.

Chain, hoist

Wrench, socket, $\frac{7}{8}$ -in., with
universal attachmentWrench, socket, $\frac{3}{4}$ -in.

Using a chain hoist, carefully swing the radiator assembly into position on the car. Connect the stay rods at the frame by installing stay rod bolts and nuts underneath car, on the top frame flange. Connect radiator to cross member by installing holding stud pads, washers, springs and nuts.

bb. Install Radiator Hose Connections.

Screwdriver

Install the inlet and outlet radiator hoses, and tighten the hose clamps.

cc. Install the Shutter Assembly.

Chain, hoist

Wrench, box, $\frac{9}{16}$ -in.

Screwdriver, heavy-duty

Wrench, open-end, $\frac{1}{2}$ -in.

Carefully lower shutter into position, using a chain hoist. Connect shutter control on lower right side of radiator. Insert and tighten the bolts and nuts that hold the shutter frame to the engine side-armor plates.

dd. Install Hood.

Hoist

Screwdriver, large

Rope, length of

Wrench, open-end, $\frac{9}{16}$ -in.

Use a rope and hoist to lift hood (with top of shutter frame attached to hood) into position. NOTE: Hood can also be slipped over front of car into position by three men. Install and tighten the nut and bolt on inside of shutter frame, near the top, on each side of frame. Install the three elastic stop nuts and bolts at rear of center panel of hood.

ee. Prepare Vehicle for Road.

Pail (or hose)

Pliers

Be sure the drain cock is tightly closed. Fill cooling system with liquid. Check oil level in crankcase. Start engine and check oil pressure, and check cooling system and lubricating system for leaks.

Section XXIV

EXHAUST SYSTEM

	Paragraph
Description and maintenance.....	175
Unit replacement	176

175. DESCRIPTION AND MAINTENANCE.

a. Description. The exhaust system consists of the exhaust pipe from the engine manifold, a three-pass muffler, and the exhaust tail pipe.

b. Maintenance. Keep cleaned out, because clogged muffler or exhaust pipe will adversely affect engine performance. Flange nuts and pipe clamps must be kept tight at all times to prevent dangerous leaks. As with all automotive units, the exhaust system must be frequently and carefully checked for both inside and outside malfunctions to insure continued satisfactory operation.

(1) INSIDE.

(a) Opened Seams in Muffler. Replace unit.

(b) Corroded Metal. Replace unit.

(c) Loose and Defective Gaskets and Baffles. Tighten or replace.

(2) OUTSIDE.

(a) Dents and Breaks from Flying Stones, Ruts and Stumps. Replace if metal is opened.

(b) Corrosion. Replace unit.

176. UNIT REPLACEMENT.

A unit should be replaced whenever leaks develop.

a. Exhaust Pipe. Remove manifold flange nuts, using a $\frac{5}{8}$ -inch open-end wrench; loosen pipe to muffler band clamp, remove gasket and take down. Use new exhaust pipe flange gasket when replacing pipe.

b. Muffler.

Wrench, open-end, $\frac{9}{16}$ -in.

Wrench, socket, $\frac{9}{16}$ -in.

Loosen exhaust to muffler band clamp, remove muffler and tail pipe U-bolt clamps and slide-out muffler. To install a new muffler, place muffler in position, install muffler and tail pipe U-bolt clamps, and tighten exhaust to muffler band clamp.

c. Tail Pipe.

Wrench, open-end, $\frac{9}{16}$ -in.

Wrench, socket, $\frac{9}{16}$ -in.

Loosen U-bolt clamp nuts at muffler, remove U-bolt clamp nuts at end of tail pipe, and slide out pipe.

SCOUT CAR M3A1

Section XXV

FRAME

	Paragraph
Frame	177
Pintle and tow hooks	178
Roller	179
Bumpers	180

177. FRAME.

The chassis frame consists of channel sections braced and reinforced with pressed steel cross members.

178. PINTLE AND TOW HOOKS.

Towing and lifting facilities are provided at the front of the vehicle by two tow hooks, and at the rear by a standard pintle.

179. ROLLER.

The roller mounted on the front end of the frame is provided for aid in maneuvering through ditches and holes. Two compression springs, mounted on the roller support, act as shock absorbers.

180. BUMPERS.

Two bumperettes are mounted on the front of the frame at opposite sides of the roller. A bumper is provided on the rear of the vehicle as part of the body.

Section XXVI

**FUEL SYSTEM AND ACCESSORIES
(GASOLINE ENGINE POWERED VEHICLES)**

	Paragraph
Description	181
Fuel tanks	182
Fuel and vacuum pump.....	183
Filter	184
Carburetor	185
Air cleaner	186
Trouble shooting	187

181. DESCRIPTION.

The air fuel system consists of two main fuel tanks, fuel lines, a transfer and shut-off valve, a mechanical fuel pump, a carburetor, an air cleaner, throttle control, and engine manifold. The fuel take-off from each tank is through the transfer and shut-off valve where one tank or the other may be selected for the supply of fuel. Total capacity of the system (2 tanks) is 30 gallons.

182. FUEL TANKS.

Two tanks of 15-gallon capacity each are provided for each vehicle. Location of the tanks is under the two front seats. The filler cap is readily accessible from the personnel compartment. Keep filler cap tightly closed and the vent in the cap open. A drain plug is recessed into the bottom of each tank.

183. FUEL AND VACUUM PUMP.

a. Description. Fuel is drawn from the supply tanks and pumped to the carburetor by a mechanical diaphragm-type, combination fuel and vacuum pump which is attached to the crankcase and operated by an eccentric on the engine camshaft. The upper element of the pump is the vacuum section, and the lower element is the fuel pump section. The vacuum section acts as a booster in the operation of the windshield wipers at open throttle when the inlet vacuum at the manifold is too low.

b. Maintenance. The pump requires no adjustment within the scope of this text, and working parts are lubricated by engine oil which comes through the opening in the crankcase. Vacuum and fuel line connector fittings should be checked regularly for leaks. Body screws which retain the diaphragms must be kept tight to prevent air and fuel leaks, and

SCOUT CAR M3A1

the mounting screws must be tight. The metal sediment bowl may be removed for draining and cleaning.

c. Removal of Fuel and Vacuum Pump.

Screwdriver

Wrench, open-end, $\frac{1}{2}$ -in.

Wrench, open-end, $\frac{3}{8}$ -in.

Disconnect vacuum lines at pump ($\frac{3}{8}$ -in. open-end wrench). Disconnect fuel lines at pump ($\frac{1}{2}$ -in. open-end wrench). Remove two cap screws and lock washers that secure the pump, and remove pump assembly with gasket.

d. Installation.

Screwdriver

Wrench, open-end, $\frac{1}{2}$ -in.

Wrench, open-end, $\frac{3}{8}$ -in.

Use a new gasket, and place pump in position. Install two cap screws and lock washers and secure the pump to the crankcase. Connect fuel lines at pump ($\frac{1}{2}$ -in. open-end wrench). Connect vacuum lines at pump ($\frac{3}{8}$ -in. open-end wrench).

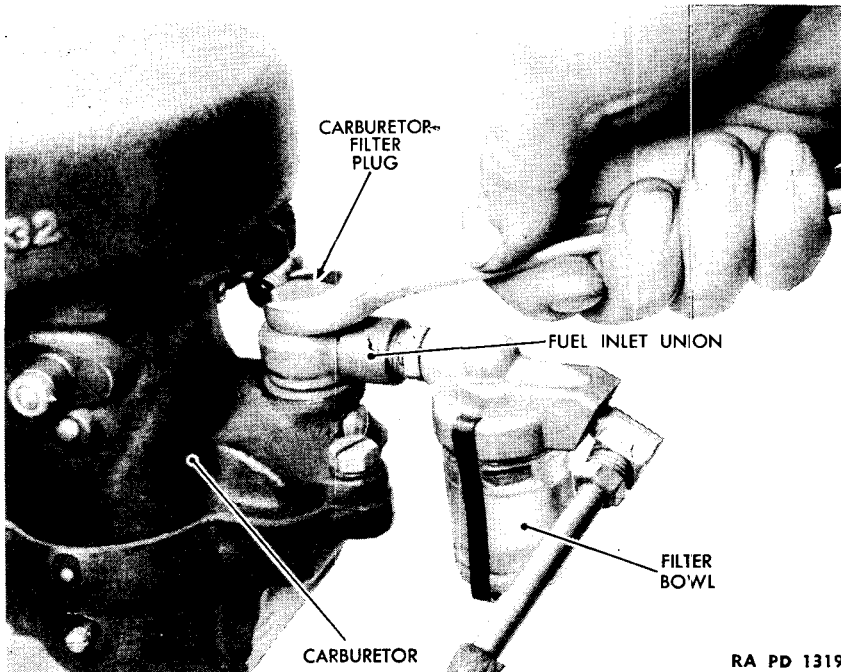

RA PD 13192

Figure 176 — Carburetor Filter Screw Removal - (Gasoline Engine)

**FUEL SYSTEM AND ACCESSORIES
(GASOLINE ENGINE POWERED VEHICLES)**

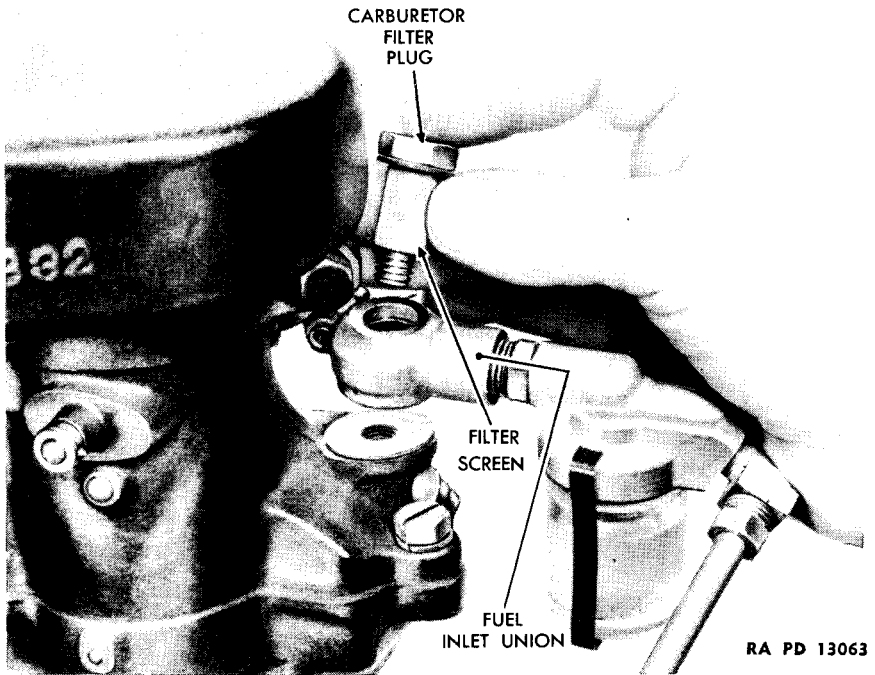

**Figure 177 — Carburetor Filter Screw and Screen Removal -
(Gasoline Engine)**

184. FILTER.

a. A fuel filter between the pump and carburetor provides a settling bowl for sediment and water. To clean, remove filter bowl spring clip, and gasket (fig. 175), and the filtering element (figs. 173 and 174). Carefully clean the latter with SOLVENT, dry-cleaning, or unleaded gasoline, and blow out with compressed air. In replacing, mount gasket carefully and hand-tighten filter and bowl elements. Keep fuel lines tight. The carburetor filter plug should be removed and cleaned with SOLVENT, dry-cleaning, or gasoline at the same time the fuel filter is cleaned. To remove, disconnect the union plug and remove the union assembly, then slide the screen from the plug.

b. Current production vehicles are being equipped with new type metal bowl gasoline filter which eliminates failure of the filter due to glass bowl breakage. Failure of the glass filter on older vehicles should be corrected by installation of the metal bowl filter.

SCOUT CAR M3A1

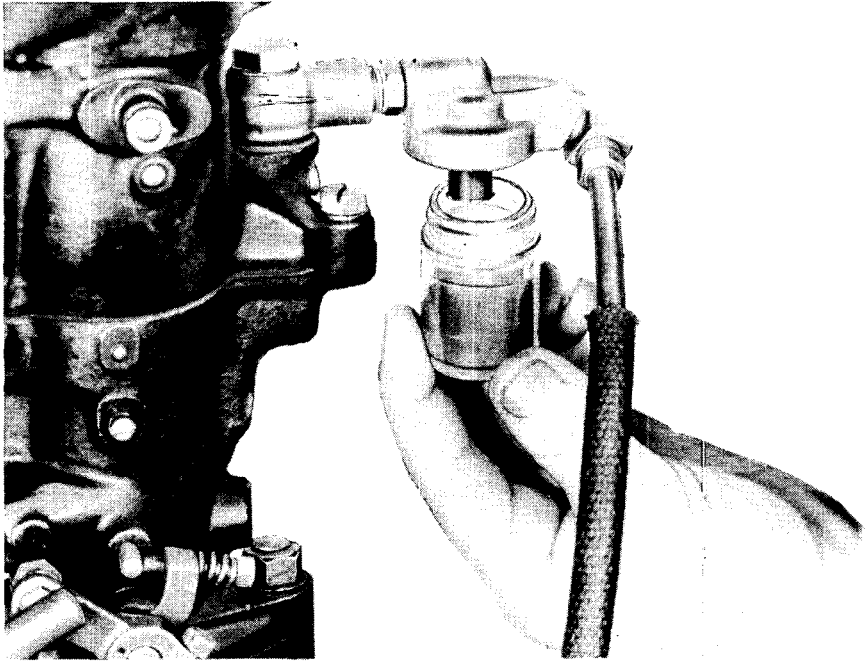

RA PD 13123

Figure 178 — Carburetor Filter Bowl Removal - (Gasoline Engine)

185. CARBURETOR.

a. **Description.** The carburetor is of the downdraft, double-venturi type. Metering jets are fixed, with the exception of the idling adjusting screws. The latest type carburetor (figs. 179 and 180) employs a secondary venturi to aid in complete vaporization of the fuel. It is designed with a vacuum-controlled power jet and accelerating system. These auxiliary jet systems are to provide the extra fuel needed for certain operations. By adding fuel only when necessary, it is possible to obtain good fuel economy in the normal range of operation without sacrificing performance.

b. **Maintenance and Adjustment.** The carburetor needs very little attention, if properly installed. Check carburetor to manifold attachment and if an air leak appears, remove carburetor to check gasket, and replace if faulty.

(1) **IDLING.** Warm engine to at least 120 F and set throttle stop screw for approximately 400 revolutions per minute. Adjust idling screw with screwdriver, so that engine idles smoothly.

(2) **MIXTURE.** Turn adjusting screw clockwise to make richer, and counterclockwise to make leaner.

**FUEL SYSTEM AND ACCESSORIES
(GASOLINE ENGINE POWERED VEHICLES)**

(3) **CHOKE.** The choke control should be checked to see that the choke valve is fully open with the button against the panel, and fully closed with the button fully out.

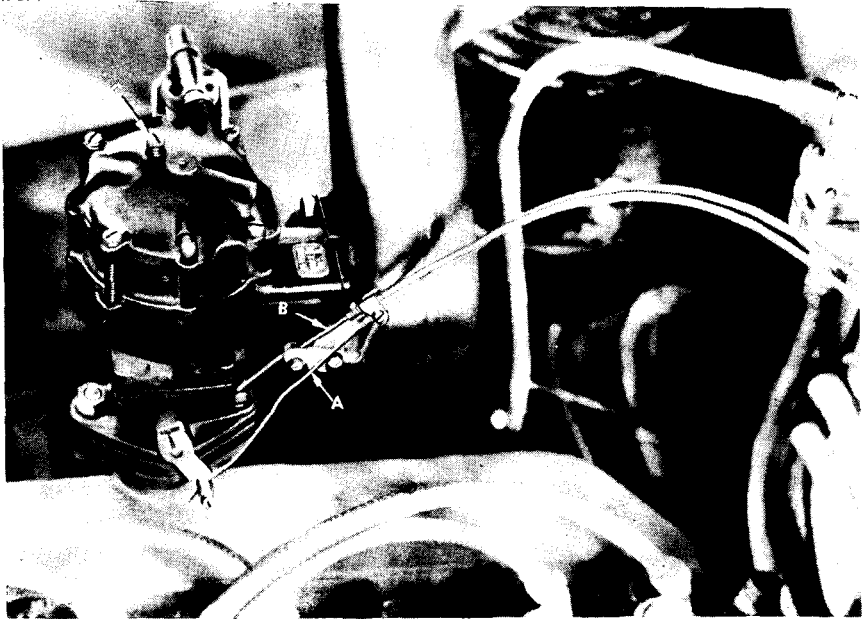

A — ACCELERATOR CABLE
B — CHOKE CONTROL CABLE

C — IDLING ADJUSTING SCREW RA PD 42214

Figure 179 — Carburetor - Installed - Left Side - (Gasoline Engine)

c. Removal of Carburetor.

Screwdriver

Wrench, open-end, $\frac{1}{2}$ -in.

Wrench, open-end, $\frac{7}{8}$ -in.

Wrench, open-end, $\frac{5}{8}$ -in.

Remove air intake pipe by loosening the hose clamp, and loosening the connection at top of carburetor. (For latest models, air intake pipe is located to the rear of the carburetor looking from driver's seat.) Using a screwdriver, disconnect the hand throttle and choke wire. Disconnect the ball joint connection of the accelerator rod by removing the nut and lock washer, using a $\frac{7}{8}$ -inch open-end wrench. Use a $\frac{1}{2}$ -inch open-end wrench to disconnect the gas line to the fuel filter. Remove two nuts and lock washers at the base of the carburetor, using a $\frac{5}{8}$ -inch open-end wrench (fig. 181). **NOTE:** Unscrew nuts evenly, lifting carburetor at the same time, so that the carburetor will not cock and break the base. Lift the carburetor up and away from the studs (fig. 182).

SCOUT CAR M3A1

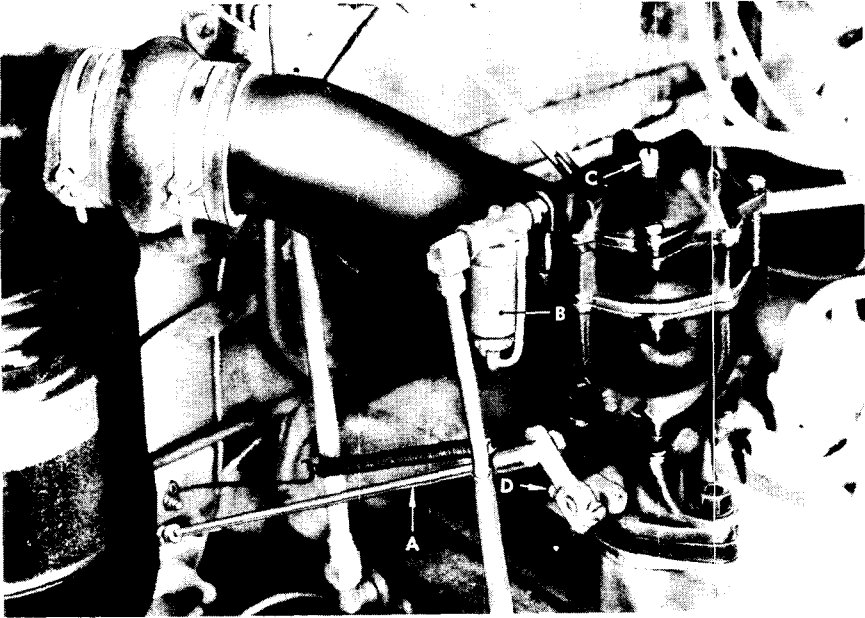

A — ACCELERATOR CONTROL ROD C — IDLING ADJUSTING SCREW
B — FUEL FILTER (METAL BOWL) D — THROTTLE STOP SCREW

RA PD 42215

Figure 180 — Carburetor - Installed - Right Side - (Gasoline Engine)

d. Installation.

Screwdriver

Wrench, open-end, $\frac{7}{16}$ -in.

Wrench, open-end, $\frac{1}{2}$ -in.

Wrench, open-end, $\frac{5}{8}$ -in.

Place new gasket in position. Install the carburetor in position on the studs. Install the two lock washers and nuts at the base of the carburetor, using a $\frac{5}{8}$ -inch open-end wrench. Connect the gas line to the fuel filter, using a $\frac{1}{2}$ -inch open-end wrench. Connect the ball joint connection of the accelerator rod by installing the lock washer and nut, using a $\frac{7}{16}$ -inch open-end wrench. Connect the hand throttle and choke wire, using a screwdriver. Install the air intake pipe, tightening the connection at the top of the carburetor with a $\frac{1}{2}$ -inch open-end wrench, and tightening the hose clamp with a screwdriver.

186. AIR CLEANER.

a. Description. The air cleaner is of the oil-bath type and is mounted on the dash.

b. Maintenance.

(1) All connections between air cleaner and carburetor should be inspected and should be kept tight.

FUEL SYSTEM AND ACCESSORIES (GASOLINE ENGINE POWERED VEHICLES)

(2) The oil-bath cup should be inspected daily and kept filled with used crankcase oil or OIL, engine, seasonal grade, to the oil level mark indicated on the cup. Do not remove oil cup while engine is running.

(3) Each time the engine crankcase is drained, or at intervals of 2,000 miles, the air cleaner cup should be cleaned thoroughly and re-filled with OIL, engine, seasonal grade. Oil that has been drained from the engine crankcase is satisfactory for this purpose.

(4) Occasionally, the air cleaner should be removed from the dash and cleaned by washing in SOLVENT, dry-cleaning, to remove the accumulation of dust and dirt from the air filter element.

c. Removal.

Screwdriver

Wrench, open-end, $\frac{9}{16}$ -in.

Wrench, open-end, $\frac{1}{2}$ -in.

Remove the air intake pipe, using a screwdriver on the hose clamp and a $\frac{1}{2}$ -inch open-end wrench on the carburetor. Remove the four

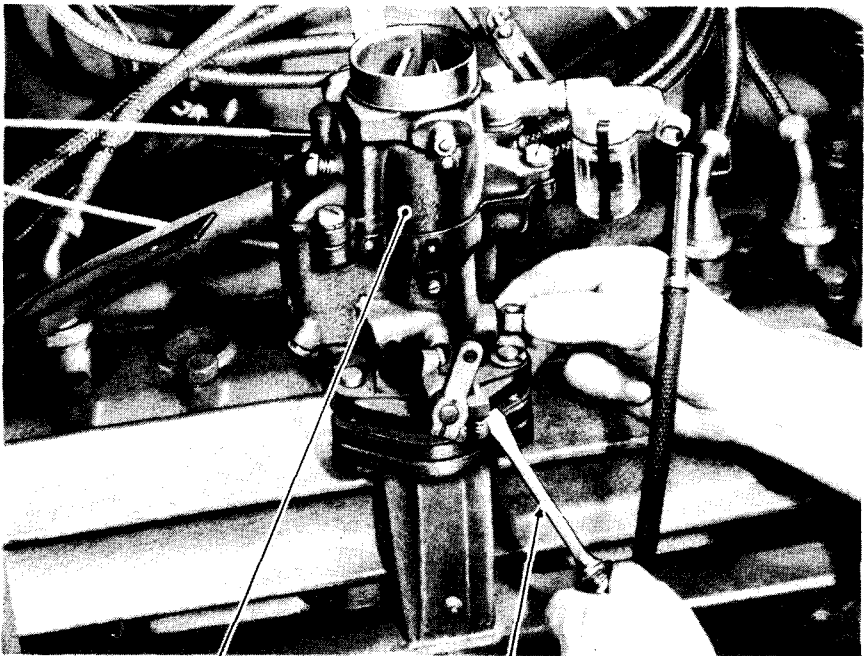

CARBURETOR

SCREW DRIVER

RA PD 13191

**Figure 181 — Removing Nuts Holding Carburetor to Manifold -
(Gasoline Engine)**

SCOUT CAR M3A1

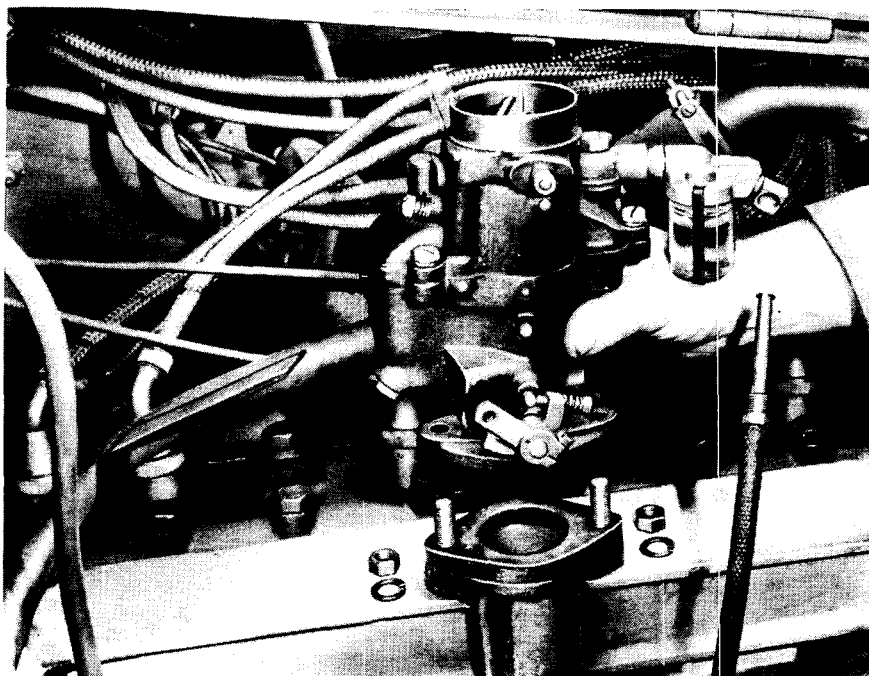

RA PD 13102

Figure 182 — Removing Carburetor - (Gasoline Engine)

nuts and bolts on the dash, using a $\frac{9}{16}$ -inch open-end wrench. Lift out the assembly.

d. Installation.

Screwdriver

Wrench, open-end, $\frac{9}{16}$ -in.

Wrench, open-end, $\frac{1}{2}$ -inch

Place the assembly in position and install the four nuts and bolts, using a $\frac{9}{16}$ -inch open-end wrench. Install the air intake pipe, using a screwdriver on the hose clamp and a $\frac{1}{2}$ -inch open-end wrench on the carburetor.

187. TROUBLE SHOOTING.

Many symptoms which might be attributed to the air fuel system are, in reality, due to faulty ignition. Before attempting any but the obviously required adjustments, check the ignition system thoroughly.

a. Fuel.

(1) **SUPPLY.** The fuel supply should be checked regularly; in the case of an inaccurate fuel gage, a dip stick will prove useful. If the

FUEL SYSTEM AND ACCESSORIES (GASOLINE ENGINE POWERED VEHICLES)

engine has stopped for reason of lack of fuel, resulting from empty tanks, the fuel supply should be replenished and the engine should be cranked for about 15 seconds (with the ignition off, the choke out, throttle shut), to draw fuel into the pump and thence into the carburetor.

(2) **IMPURITIES.** Failure of the engine to start may be caused by water, ice or dirt in the fuel system, as observed from an examination of the fuel pump sediment bowl. Clean the strainers in the fuel pump and empty the bowl; drain the fuel tanks until the fuel flows free of impurities; disconnect the fuel lines and blow them out with air. If ice is found, heat the parts with boiling water before cleaning. Water in the fuel tanks comes from the condensation of moisture in the air, which is drawn into the tanks as the fuel is used, and it accumulates more rapidly in cold damp weather and when the tanks are relatively empty of fuel.

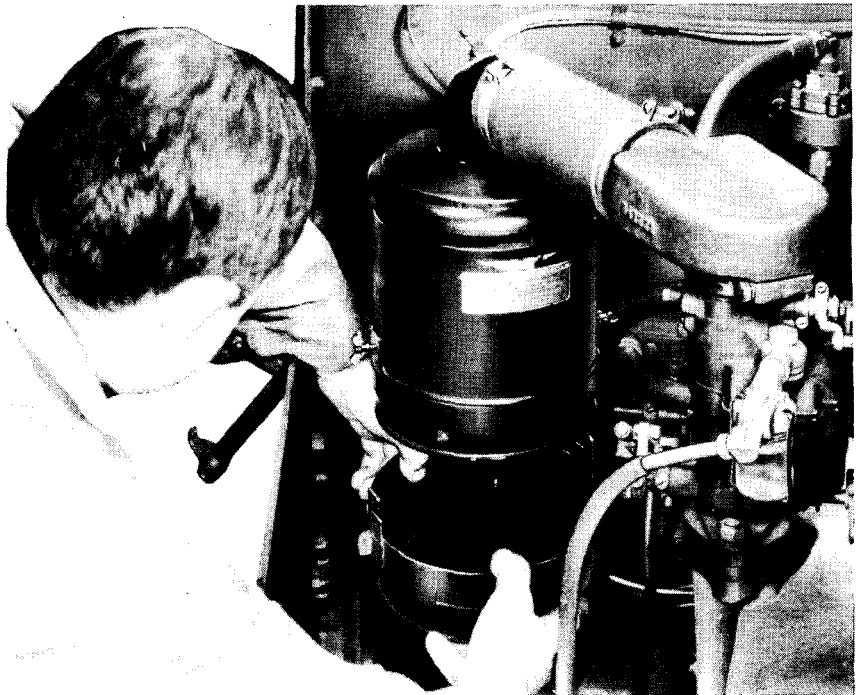

RA PD 13084

**Figure 183 — Removing Air Filter Base to Change Oil -
(Gasoline Engine)**

SCOUT CAR M3A1**b. Carburetor.**

(1) **FLOODING.** Choking too long during cranking floods the cylinders and prevents starting. Push in the choke, turn on the ignition switch, open the throttle wide (do not pump), and crank the engine for about 10 seconds. When the engine starts, partly close the throttle; do not use the choke again unless it is necessary to keep the engine from stalling.

(2) **CHOKE VALVE SETTING.** If the engine will not start after cranking for 5 seconds, with the choke pulled out and with the ignition satisfactory, the choke valve may not be closing completely. Examine the choke valve at the carburetor when the choke button is pulled out all the way; and if the valve has not closed, change the setting of the choke wire so that the valve closes.

(3) **NO FUEL IN CARBURETOR.** If a hissing sound is not heard in the carburetor when cranking with the choke out, a lack of gasoline is indicated in the carburetor. Test by dismounting the fuel supply pipe to the filter. If there is not a steady flow from the fuel pipe, the trouble must be traced back through the fuel system, with the engine being turned over for the test. If the trouble is in the carburetor, check with proper authority, or replace.

(4) **MIXTURE.** If the engine runs irregularly at idling speed, or black smoke appears in the exhaust and the muffler backfires, the carburetor mixture is too rich. Dry soot in the shell, or porcelain near the points of the spark lugs, also indicates this condition. If a warm engine backfires into the carburetor when accelerating or when the vehicle is running down hill in gear, the air fuel mixture is probably too lean. If the spark plug porcelain is a light straw color, the mixture is extremely lean. Excessive burning of spark plug points also indicates a lean mixture, or an incorrect plug. Adjust the carburetor correctly; summer driving requires an adjustment different from that for winter driving. A dirty air cleaner causes a rich mixture and loss of power.

c. Fuel Pump.

(1) **NO FUEL.** Disconnect the fuel pipe at the carburetor, shut off the ignition, and turn the engine with the starter. If no fuel appears, the trouble may be in the supply line, pump or strainers. Examine the tubing for kinks and leaks, and check strainer bowl for sediment. If the bowl is dirty, remove and clean it, and clean the strainer screen. Replace the gasket if it is broken, and replace the bowl if it has a chipped edge, checking for a tight fit and proper gasket installation. Disconnect the fuel pipe from the tank at the fuel pump, and apply air to the supply tank to test the condition of fuel line and fuel flow. If the line is open and the connections are tight, the pump is defective and must be repaired or replaced.

**FUEL SYSTEM AND ACCESSORIES
(GASOLINE ENGINE POWERED VEHICLES)**

(2) **LEAKS.** In case of leakage at the diaphragm, tighten the cover screws alternately and securely. Sometimes there appears to be a leak at the diaphragm, whereas the leak actually exists at one of the pipe fittings and the fuel runs down around the diaphragm flange. Leakage of fuel through the body vent hole, a worn or punctured diaphragm, loose diaphragm nut, or defective pull rod gasket requires replacement or adjustments. Complete disassembly of fuel pumps is not authorized for the using arms.

d. Manifold. A steady, whistling sound at the manifold indicates a leaky gasket, and irregular engine running at idling speed usually results. While the engine is running, squirt oil around the inlet manifold gasket to locate points where whistling will cease. Examine hose connections at the windshield wiper and check other accessories for air leaks. Replace hose and gaskets if necessary, and tighten manifold bolts and hose connections.

e. Controls. Check for sticking linkage and frayed control wires when response to operation of the accelerator and controls becomes unsatisfactory.

SCOUT CAR M3A1

Section XXVII

BOSCH FUEL INJECTION SYSTEM (HERCULES DIESEL ENGINE)

	Paragraph
General description	188
Fuel injection pump	189
Governor	190
Check valve	191
Fuel transfer pump.....	192
Fuel nozzle and holder assembly.....	193
Fuel filter	194

188. GENERAL DESCRIPTION.

The fuel injection equipment used on this engine consists of the following:

a. The fuel injection pump which forces the fuel, under pressure, to the injectors.

b. A fuel supply pump mounted on the side of the lower part of the injection pump case, which pumps the fuel through a filter to the injection pump.

c. A vacuum governor which is mounted on the coupling end of the injection pump, controls engine speed.

d. A check valve to maintain a constant pressure in the fuel manifold.

e. Six fuel lines, through which fuel is pumped from the injection pump to the injectors.

f. Six injectors to inject fuel into the combustion chambers of the cylinders.

g. A leak-off manifold to return fuel, which was not injected, back to the pump.

189. FUEL INJECTION PUMP.

a. **Drive Gear.** The fuel pump is driven by a chain and sprocket. One sprocket is attached to the front of the camshaft and the other sprocket is fastened to the fuel pump drive shaft. An adjustment for the fuel pump drive chain is provided on the front of the gear cover. The chain is adjusted by means of an idler sprocket mounted on an eccentric, which is actuated by the adjusting screw on the front of the case.

BOSCH FUEL INJECTION SYSTEM (HERCULES DIESEL ENGINE)

b. Operation. A camshaft within the pump operates six plungers. The plungers control the amount of fuel delivered to the fuel injection nozzles. The plunger compresses the fuel and forces it through the delivery valve, fuel pipes and spring-loaded injector nozzle and into the engine combustion chamber.

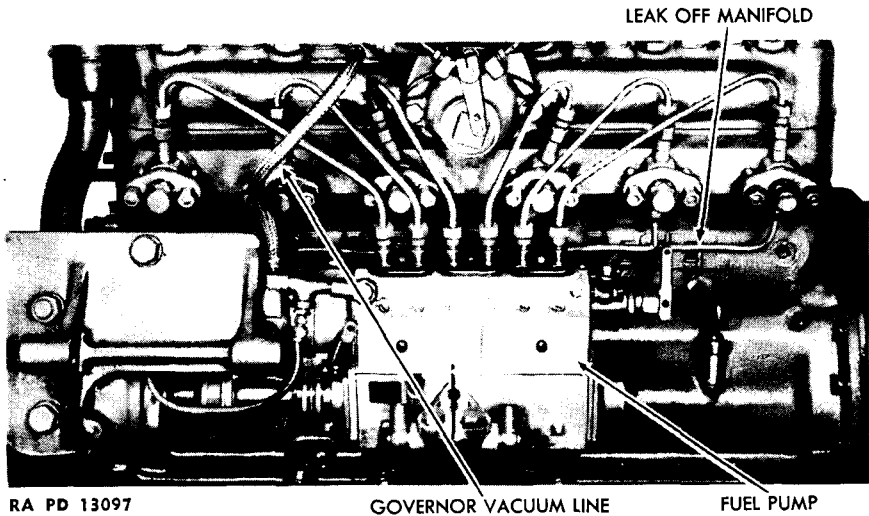

Figure 184 — Removing Governor Vacuum Line - (Hercules Diesel)

c. Removal of Fuel Injection Pump.

- | | |
|---------------------------------------|--------------------------------------|
| Screwdriver | Wrench, open-end, $\frac{1}{8}$ -in. |
| Wrench, open-end, $\frac{3}{8}$ -in. | Wrench, open-end, $\frac{3}{4}$ -in. |
| Wrench, open-end, $\frac{9}{16}$ -in. | |

(1) DETACH THE GOVERNOR VACUUM LINE.

Wrench, open-end, $\frac{9}{16}$ -in.

Unscrew the governor vacuum line at the lower connection by loosening the nut (fig. 184).

(2) DETACH THE FUEL PUMP FUEL LINES

Wrench, open-end, $\frac{11}{16}$ -in.

Loosen the fuel pump fuel lines at the barrels on top of the fuel injection pump (fig. 184).

(3) DETACH LEAK-OFF MANIFOLD FROM PUMP.

Wrench, open-end, $\frac{9}{16}$ -in.

Loosen and remove the fuel nozzle leak-off manifold from the union at the pump (fig. 185).

SCOUT CAR M3A1

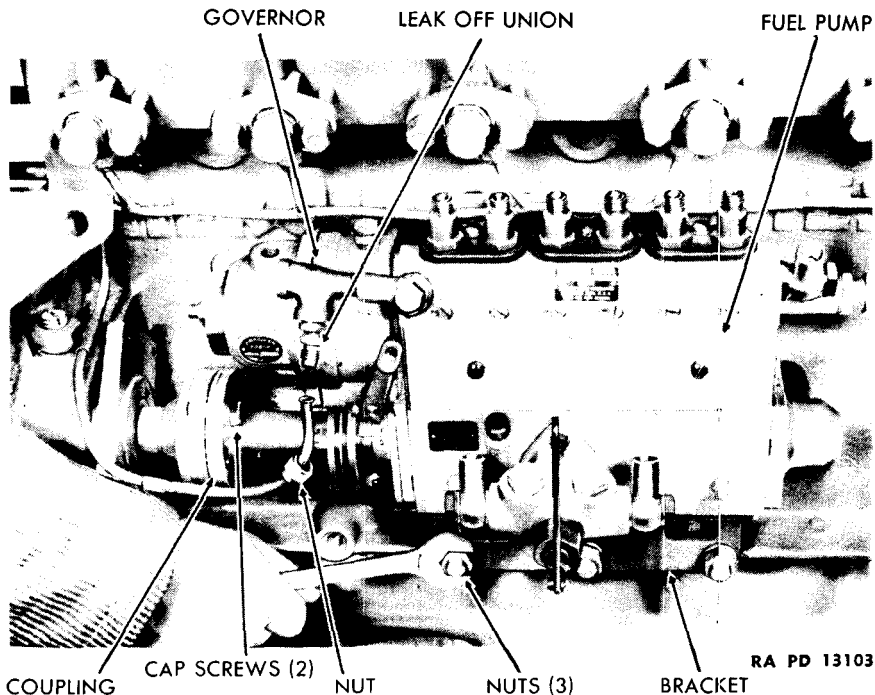

Figure 185 — Removing Fuel Injection Pump and Governor - (Hercules Diesel)

(4) DETACH GOVERNOR CONTROL WIRE.

Screwdriver

Wrench, open-end, $\frac{3}{8}$ -in.

Disconnect the control wire at the governor on the fuel transfer pump.

(5) DETACH FUEL INJECTOR SHUT-OFF WIRE.

Screwdriver.

Disconnect the shut-off wire at the pump.

(6) REMOVE FUEL INJECTION PUMP AND GOVERNOR (fig. 185).

Wrench, open-end, $\frac{9}{16}$ -in.

Wrench, open-end, $\frac{3}{4}$ -in.

Loosen and remove the two front coupling cap screws with lock washers and plain washers. (The floating member of the coupling will also come off when the pump is removed.) Loosen and remove the three nuts and washers from the pump mounting bracket studs. Lift off the fuel injection pump assembly. **NOTE:** There are two collar dowels used on the bracket studs, one on each outside stud. These dowels fit halfway in the cylinder block and halfway in the bracket. Remove these two collar dowels.

BOSCH FUEL INJECTION SYSTEM (HERCULES DIESEL ENGINE)

d. Installation.

Chisel, light

Hammer

Screwdriver

Wrench, open-end, $\frac{9}{16}$ -in.

Wrench, open-end, $\frac{3}{4}$ -in.

(1) INSTALL THE PUMP AND BRACKET.

Wrench, open-end, $\frac{3}{4}$ -in.

Position the pump and bracket on the three studs in the side of the engine case, with the two collar dowels on the outside studs halfway in the case and in the pump bracket (fig. 185). Install lock washers and nuts on these studs.

FLANGED COUPLING SHAFT CAP SCREWS

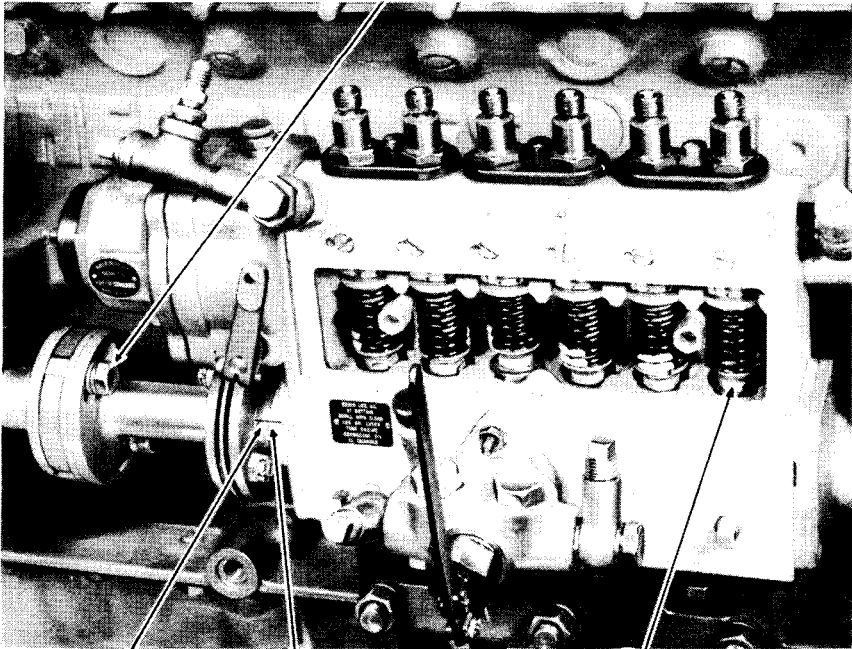

COUPLING TIMING MARK

HOUSING TIMING MARK

NO. 6 PLUNGER STARTING TO RISE

RA PD 13201

**Figure 186 — Mounting and Timing Fuel Injection Pump -
(Hercules Diesel)**

(2) TIMING FUEL INJECTION PUMP (fig. 186).

Screwdriver

Wrench, open-end, $\frac{9}{16}$ -in.

(a) Loosen the four cap screws which hold the pump on the bracket with a $\frac{9}{16}$ -inch open-end wrench.

(b) Slide the pump back and forth until a position is obtained which

SCOUT CAR M3A1

does not bind the floating member of the coupling, yet does not give it too much end play.

(c) Tighten the fuel pump in place on the bracket with a $\frac{9}{16}$ -inch open-end wrench.

(d) Rotate flywheel by means of the hand crank until "DC" mark appears in timing hole in front of the bell housing. Be sure that No. 6 piston is just completing the compression stroke and starting on the power stroke. This can be determined by removing No. 6 nozzle and placing the thumb or finger over the nozzle opening in the engine and feeling the pressure. The point of greatest pressure indicates when the compression stroke is ended.

(e) Next, rotate the crankshaft in the direction of the degree graduation marks on the front face of the flywheel (which is counterclockwise), until the graduation marked 24 degrees is directly in line with the mark in the center of the timing hole in the bell housing (fig. 187).

(f) The crankshaft is then spotted at 24 degrees before top dead center, the point at which the fuel injection pump is set for port closing.

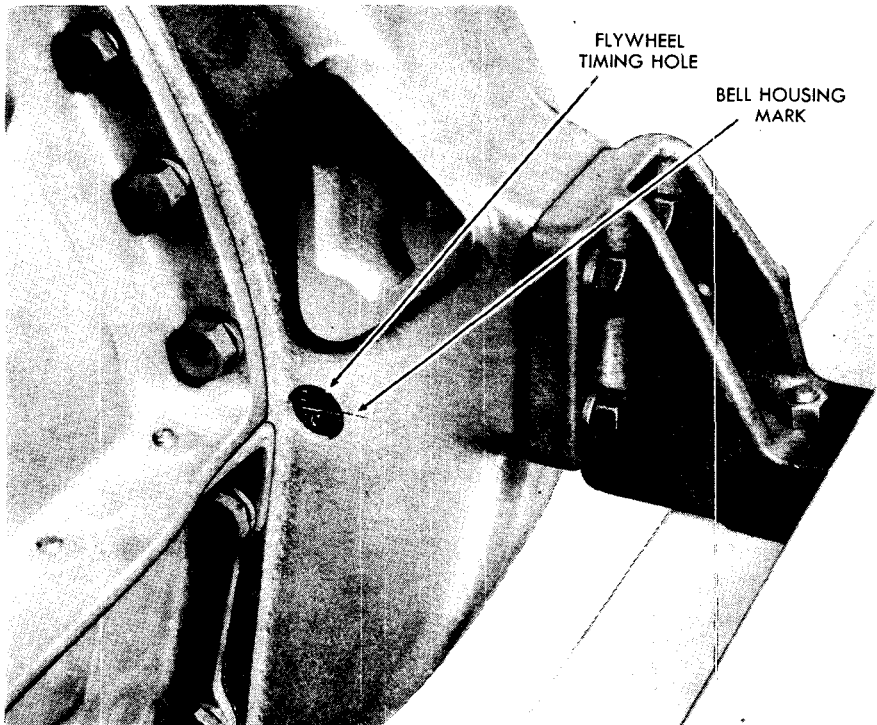

RA PD 13202

Figure 187 — Timing Hole in Bell Housing - (Hercules Diesel)

BOSCH FUEL INJECTION SYSTEM (HERCULES DIESEL ENGINE)

(g) The front of the flywheel is marked with a line "DC" (dead center) and from this line are graduations designating degrees of crankshaft travel. From "DC" these graduation lines are marked 5 degrees—10 degrees, then every 2 degrees up to 30 degrees. They are numbered every 10 degrees.

(h) Remove inspection cover plate from the side of the fuel pump with a screwdriver. Rotate fuel pump coupling on the fuel pump until No. 6 plunger spring begins to rise. Now line up the heavy marking on the fuel pump coupling with the heavy marking on the fuel pump hub (fig. 186).

(i) Install cap screws with lock washers and plain washers in the adjusting slots in the front end of the flanged coupling shaft (fig. 186). Plain washers are installed next to the flange. Tighten the cap screws with a $\frac{1}{16}$ -inch open-end wrench.

(3) **SPOTTING THE FLYWHEEL.** There may be times when it is necessary to install and time a new fuel pump and coupling without the timing marks on the coupling. This is done by what is known as the flow method. This procedure follows:

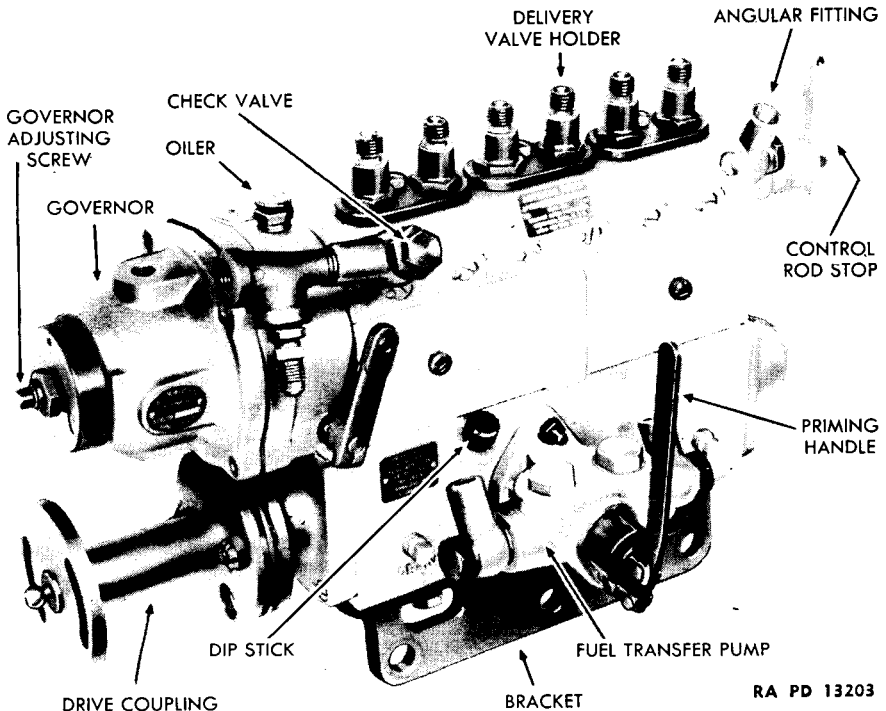

RA PD 13203

Figure 188 — The Fuel Pump and Governor - (Hercules Diesel)

SCOUT CAR M3A1

(a) Rotate flywheel by means of hand crank until "DC" mark appears in timing hole in bell housing. Be sure No. 6 piston is just completing the compression stroke and beginning the power stroke, which can be determined by observing that the No. 1 cylinder exhaust valve is nearly closed.

(b) Rotate engine in direction of degree graduation marks, which is counterclockwise, until the graduation marked 24 degrees is directly in line with the mark in the center of the timing hole in the bell housing. This will then have the crankshaft spotted at 24 degrees before top center, at which point the fuel pump is set for port closing.

(c) Install pump assembly, tightening all attaching screws but leaving the rear half of coupling loose from front half, so pump shaft can be rotated while the drive shaft remains stationary.

(d) Connect all fuel suction and discharge pipes from fuel tank to pump. Install all fuel lines, except to No. 6 cylinder.

(e) With governor stop lever in wide open or full load position, prime the pump.

(f) Put governor stop lever in STOP position and remove pump delivery valve holder from No. 6 pumping unit. Remove delivery valve and spring, but not the seat. Replace delivery valve holder, finger-tight,

(g) Put governor stop lever in wide open or full load position. Fuel should now rush out of the delivery valve holder. Rotate pump shaft over the top and toward the engine by means of the rear half of coupling until fuel flow stops. If fuel did not flow when governor stop lever was first opened, rotate shaft in direction of its normal rotation until fuel flows. Then rotate shaft in the opposite rotation to where flow is just barely shut off. Use hand priming pump to keep fuel pump manifold supplied with oil.

(h) Very carefully rotate shaft until fuel barely flows, then back to point where flow is barely shut off. Repeat this two or three times until a movement of less than $\frac{1}{8}$ inch on the circumference of the coupling is the difference between fuel flowing and not flowing. This determines where the pump plunger just closes the fuel port and begins the period of building up pressure in the lines and nozzles so that injection can start. This adjustment must be extremely accurate.

(i) With cap screws provided, connect the front and rear half of the coupling together. Be sure these screws are tight so no slippage can occur, and yet do not strip the threads. It is not advisable to use a wrench over 6 inches long for tightening. Also observe if any slight movement, which might occur while tightening the screws, has started the fuel flowing again from the delivery valve holder. When these

BOSCH FUEL INJECTION SYSTEM (HERCULES DIESEL ENGINE)

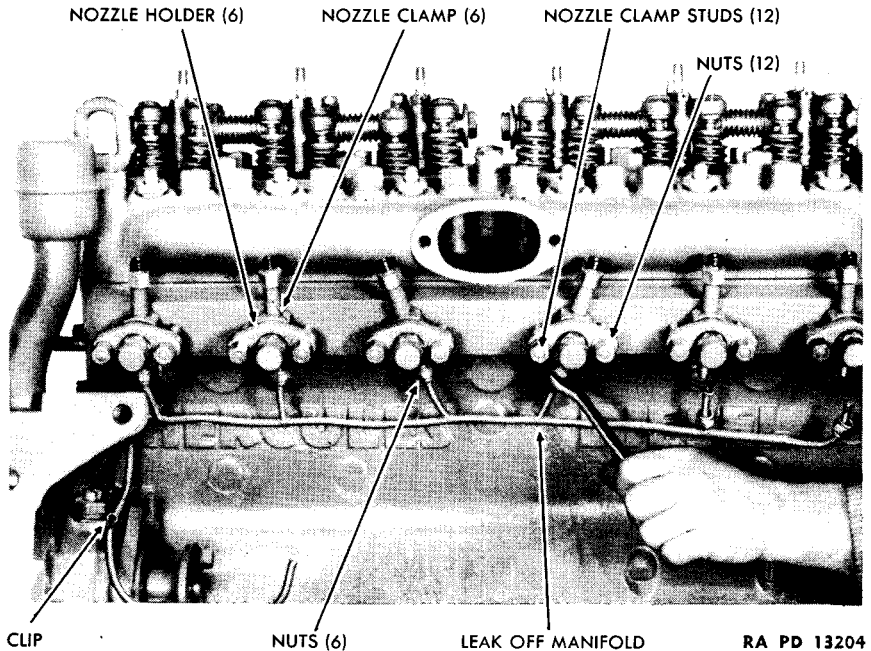

Figure 189 — Fuel Nozzle and Holder Removal - (Hercules Diesel)

screws are tight, no fuel should flow. The fuel pump is now timed to close the ports at 24 degrees before top center.

(j) Put governor stop lever in STOP position again. Remove delivery valve holder and replace the delivery valve and spring. Install delivery valve holder, tightening firmly. Be careful not to get any dirt, water, or any other foreign matter in or on any of these parts. Do not tighten so tightly as to distort fuel pump case.

(k) Connect fuel line to pump No. 6 cylinder. Prime fuel lines, being sure the fuel pump, strainer and all lines are full of fuel, without air.

(l) Start engine. If after checking all points engine runs ragged, stop and recheck timing.

(m) After engine is operating smoothly and has been properly warmed up, stop the engine.

(n) With light chisel and hammer, enlarge the single mark on the front hub and put a corresponding mark on the other hub so these two parts can be lined up together at any future time without the necessity of flowing the pump.

SCOUT CAR M3A1

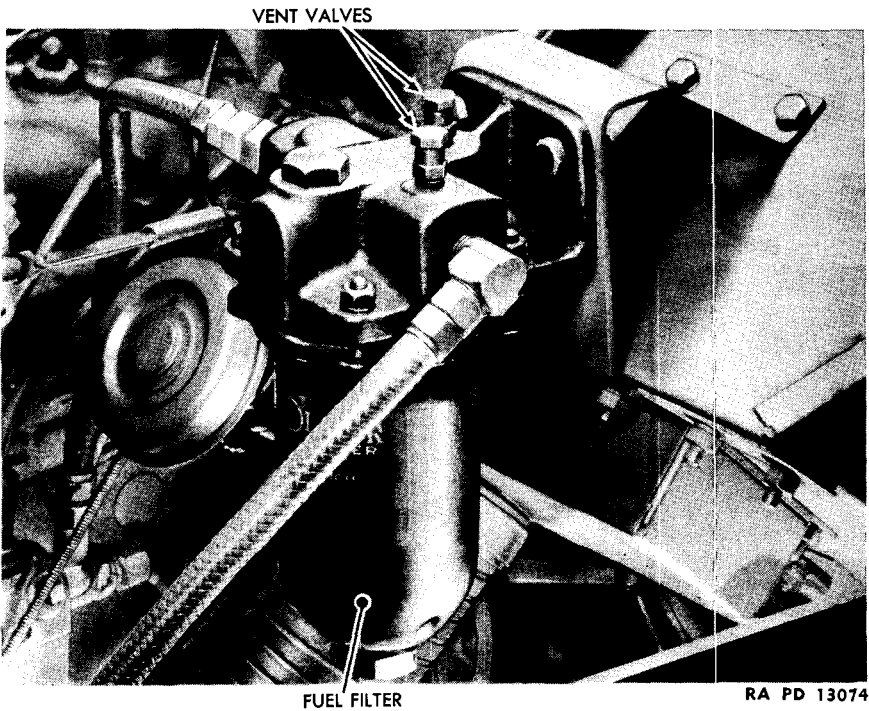

Figure 190 — Fuel Filter Installed - (Hercules Diesel)

- (4) CONNECT THE LEAK-OFF MANIFOLD TO THE PUMP (fig. 185).

Wrench, open-end, $\frac{9}{16}$ -in.

Connect the leak-off manifold at the union at the pump.

- (5) ATTACH THE FUEL PUMP FUEL LINES AT THE PUMP (fig. 184).

Wrench, open-end, $\frac{11}{16}$ -in.

Attach the fuel pump fuel lines at the barrels at the top of the fuel pump.

- (6) ATTACH GOVERNOR VACUUM LINE AT THE PUMP (fig. 184).

Wrench, open-end, $\frac{9}{16}$ -in.

Install the lower connection of the governor vacuum line to the fuel pump.

- (7) INSTALL GOVERNOR CONTROL WIRE.

Screwdriver

Wrench, open-end, $\frac{3}{8}$ -in.

Connect the control wire at the governor on the fuel transfer pump.

BOSCH FUEL INJECTION SYSTEM (HERCULES DIESEL ENGINE)

(8) INSTALL FUEL INJECTOR SHUT-OFF WIRE.

Screwdriver

Connect the shut-off wire at the pump.

e. **Lubrication.** The pump is oiled by means of a pool of oil in the base of the pump; and the oil level should be maintained at all times to the mark on the dip stick. New oil is added through the dip stick hole. This oil should be the same as is used in the lubrication of the engine. Drain and flush out and refill with clean engine oil every time the engine crankcase oil is changed. A drain plug is provided in the base of the housing.

190. GOVERNOR.

a. **Description (fig. 188).** The vacuum-type governor is located at the forward end of the fuel injection pump, and is connected to the air intake Venturi housing by a flexible tube. It is operated by the change in vacuum created when the throttle valve is open or closed.

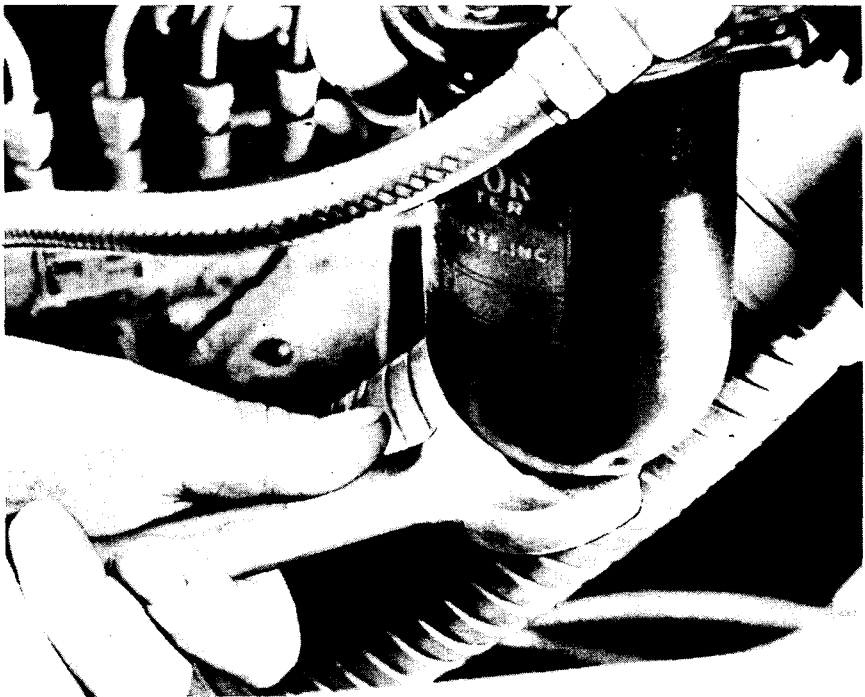

RA PD 13077

**Figure 191 — Removal of Drain Plug from Fuel Filter -
(Hercules Diesel)**

SCOUT CAR M3A1

b. Adjustment. The governor is properly adjusted when the engine leaves the factory, and further adjustment is rarely necessary. If the governor fails to control the engine speed correctly, ordnance maintenance personnel should be notified.

c. Governor Lubrication. Put about 1 tablespoon of engine oil in the oiler opening at the top of the governor every 100 hours of operation.

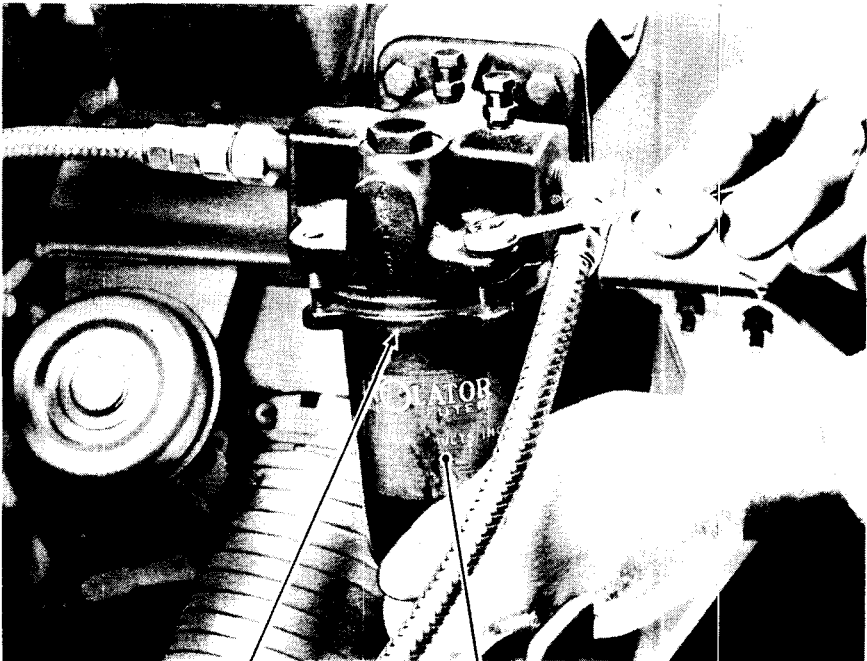

Figure 192 — Removing Filter Case - (Hercules Diesel)

191. CHECK VALVE (fig. 188).

a. Description. The check valve on the fuel outlet maintains a set pressure in the fuel manifold of the pump.

b. Maintenance. Should dirt or lint get between the valve and its seat, the valve will cease to function and the pressure in the manifold will be reduced, with a resultant drop in engine power. Remove the valve and hold it open while washing it out with SOLVENT, dry-cleaning, or fuel oil, or gasoline. Do not completely disassemble the valve.

BOSCH FUEL INJECTION SYSTEM (HERCULES DIESEL ENGINE)

192. FUEL TRANSFER PUMP (fig. 188).

a. **Description.** The fuel transfer pump is located on the lower side of the injection pump case and is operated by one of the cams on the injection pump camshaft. The pump plunger forces the fuel to the final filter, located between the transfer pump and the injection pump.

b. **Priming Device (fig. 188).** The priming handle actuates the same plunger as the camshaft. This device provides for pumping fuel through the system to aid in priming and venting a dry system. Operate the hand lever back and forth until the fuel flows freely without signs of air bubbles at the opened vents in the filter and injection pump. Should the engine be in the position where the piston in No. 4 cylinder is near the end of the compression stroke and the beginning of the power stroke, the plunger is inoperative. It will be necessary to rotate the crankshaft to some other position before priming handle can be used.

c. Fuel Transfer Pump Removal.

Wrench, open-end, $\frac{3}{8}$ -in.

Remove the fuel transfer pump and gasket from the fuel injection

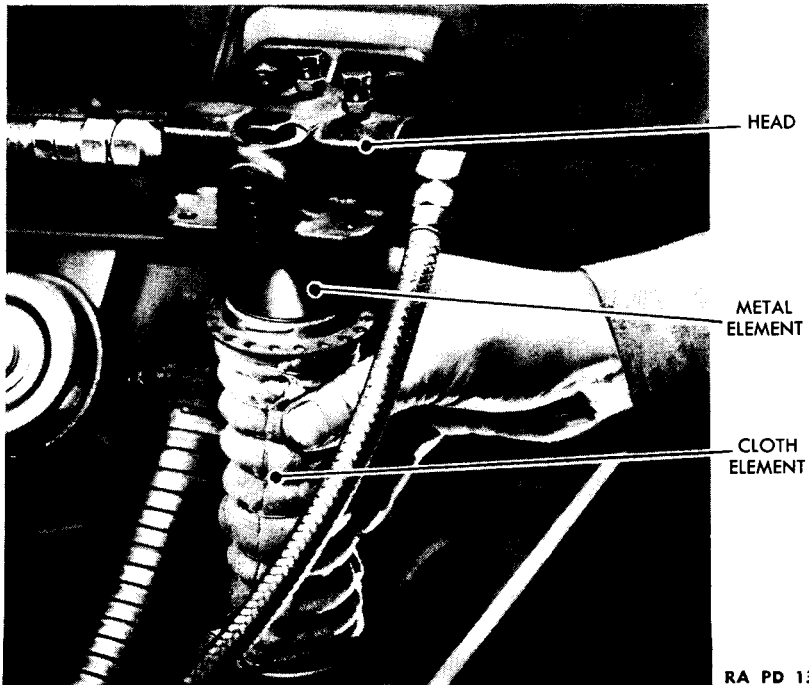

**Figure 193 — Removal of Cloth Strainer from Fuel Filter -
(Hercules Diesel)**

SCOUT CAR M3A1

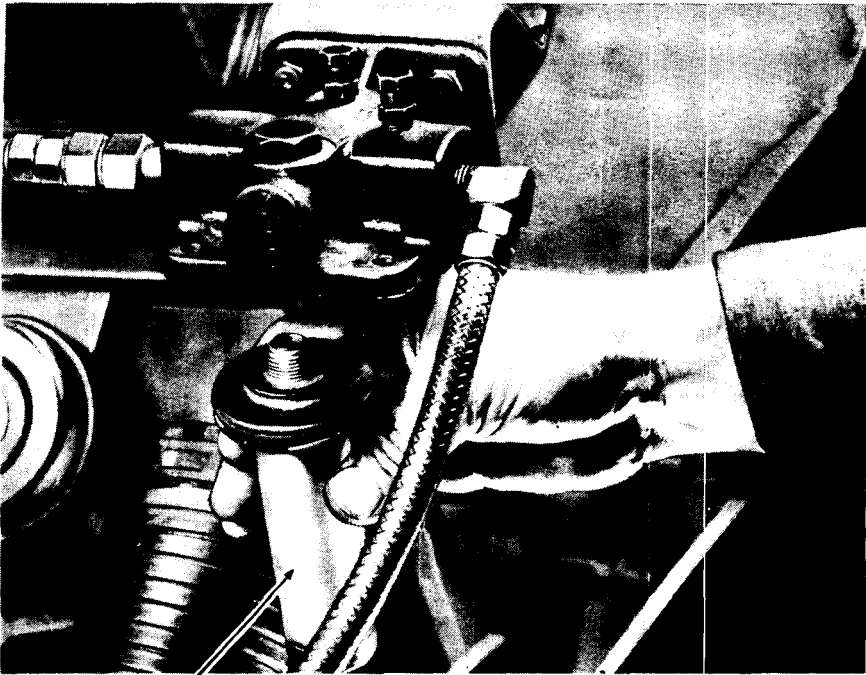

METAL ELEMENT

RA PD 13072

**Figure 194 — Removal of Screen Filter from Fuel Filter -
(Hercules Diesel)**

pump body by disconnecting the two hoses and removing the three nuts and lock washers from the mounting studs. Lift off the pump.

d. Transfer Pump Installation.

Wrench, open-end, $\frac{3}{8}$ -in.

Place a new gasket in position and attach the fuel transfer pump assembly to the fuel injection pump with three lock washers and nuts. Connect the two hoses.

193. FUEL NOZZLE AND HOLDER ASSEMBLY (fig. 189).

a. Description. Fuel is fed to the inlet connection of the nozzle and through drilled passages to the nozzle body. The nozzle pintle is kept on its seat by a spring which bears against it until a pressure of 1,650 pounds is delivered. This raises the pintle off its seat and allows the injection of fuel into the combustion chamber.

BOSCH FUEL INJECTION SYSTEM (HERCULES DIESEL ENGINE)

b. Removal of Fuel Nozzle (fig. 189).

Screwdriver

Wrench, open-end, $\frac{11}{16}$ -in.

Wrench, open-end, $\frac{9}{16}$ -in.

Disconnect the fuel pump fuel line at the injector nozzle by loosening the nut which holds the line to the injector. Disconnect the leak-off manifold from the injector nozzle by loosening the union nut which holds the manifold to the injector. Remove the nozzle clamp stud nuts which hold the nozzle holder, and remove the nozzle holder and nozzle assemblies. If the engine has been in operation for a considerable length of time, it may be necessary to pry out the nozzle holder with a screwdriver, due to carbon deposits.

c. Installation.

Wrench, open-end, $\frac{9}{16}$ -in.

Wrench, open-end, $\frac{11}{16}$ -in.

Insert the fuel nozzle in the nozzle opening in the side of the engine. The nozzle will shoulder against the copper seal in the engine nozzle

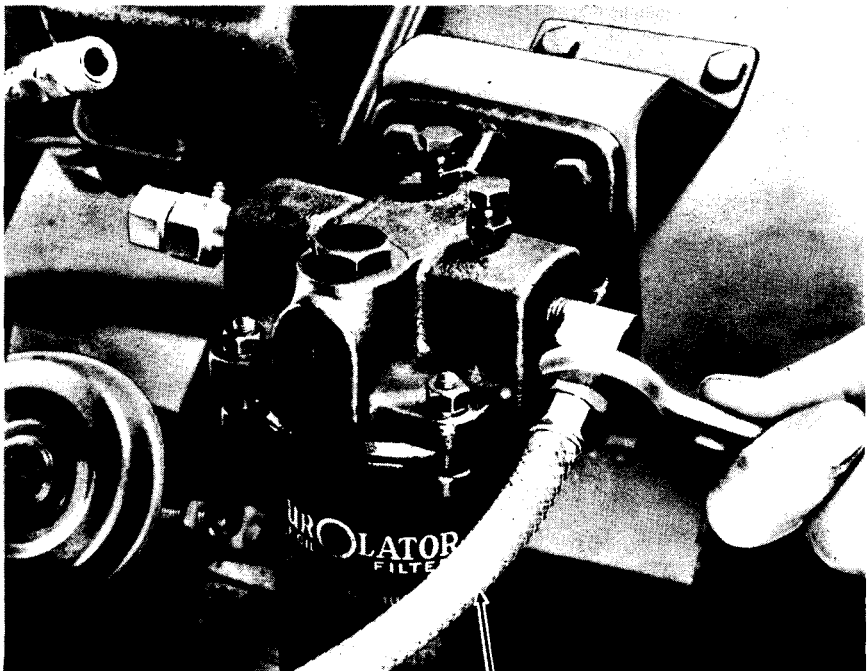

INLET LINE

RA PD 13073

**Figure 195 — Disconnecting Inlet Hose to Fuel Filter -
(Hercules Diesel)**

SCOUT CAR M3A1

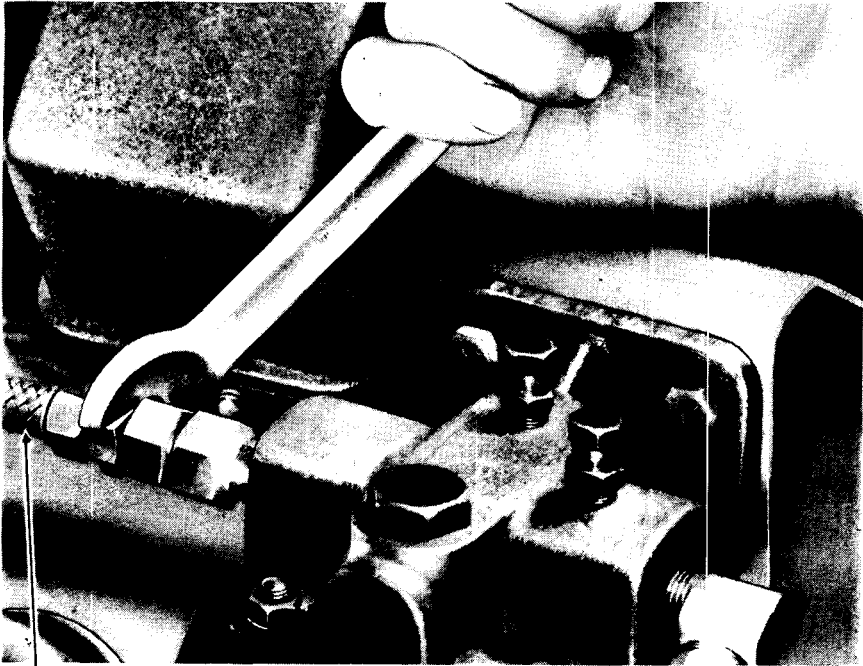

OUTLET LINE

RA PD 13082

**Figure 196 — Disconnecting Outlet Hose from Fuel Filter -
(Hercules Diesel)**

opening. Place the nozzle clamp in position and secure in place loosely by screwing the clamp stud nuts on by hand. Install the fuel pump fuel line on the nozzle. Tighten the clamp stud nuts on the nozzle clamp. Install the leak-off manifold connection on the nozzle.

194. FUEL FILTER.

a. Description. A metal and cloth combination filter is installed between the fuel transfer pump and the fuel injection pump. It contains a metal element surrounded by a fabric element. The metal element not only acts as a second stage of filtration, but also acts as a safeguard against cloth fibers from the fabric element passing into the outgoing stream of filtered oil. It further prevents the release of accumulated dirt if the fabric element is ruptured.

b. Cleaning. The filtering elements must be removed from the case every 2,000 miles for cleaning. The procedure is as follows:

- (1) Open both vent valves in the top of the filter (fig. 190).

BOSCH FUEL INJECTION SYSTEM (HERCULES DIESEL ENGINE)

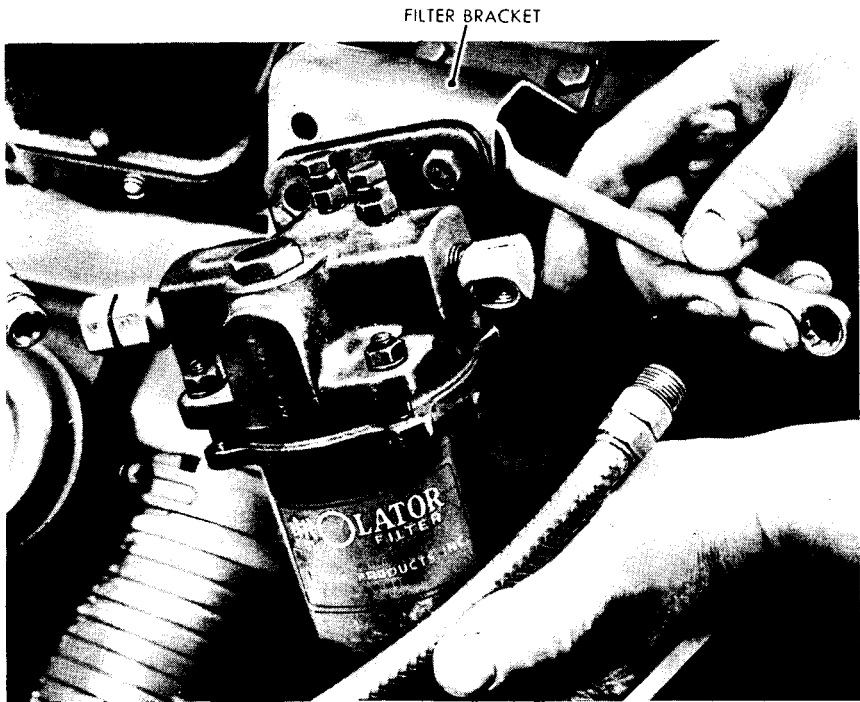

RA PD 13076

Figure 197 — Removing Fuel Filter Assembly - (Hercules Diesel)

(2) Drain the filter by removing the drain plug in the bottom of the filter, using a $1\frac{1}{8}$ -inch open-end wrench (fig. 191).

(3) Remove the case by unscrewing the four nuts with lock washers that attach the case to the mounting flange, using a $\frac{1}{2}$ -inch open-end wrench (fig. 192).

(4) Remove the cloth element by twisting it to the right to release the bayonet catch by which it is attached to the metal unit (fig. 193).

(5) Remove the metal element by unscrewing it from the head casting (fig. 194).

(6) Wash both elements and the case in gasoline or SOLVENT, dry-cleaning. Do not use a wire brush or scraper. Use a soft cloth or bristle brush. The fabric element should be cleaned by placing it, open end down, in a partially filled can or bucket of cleaning fluid. Compress the element and allow it to expand. Repeat until dirt on the outside of the cloth is removed. Use care to prevent dirt from entering the inside of the cloth. The fabric element should be replaced if worn or torn.

SCOUT CAR M3A1

(7) Replace the element and case.

(8) Tighten the vent valves.

c. Removal of Fuel Filter.

Wrench, box, $\frac{7}{16}$ -in.

Wrench, open-end, $\frac{5}{8}$ -in.

Disconnect the inlet and outlet lines at the filter, using a $\frac{5}{8}$ -inch open-end wrench (figs. 195 and 196). Remove the two nuts which hold the filter to the filter bracket, using a $\frac{7}{16}$ -inch box wrench, as shown in figure 197, and remove the filter.

d. Installation.

Wrench, box, $\frac{7}{16}$ -in.

Wrench, open-end, $\frac{5}{8}$ -in.

Position the filter on the bracket and attach by installing the nuts on the bolts, using a $\frac{7}{16}$ -inch box wrench (fig. 197). Connect the inlet and outlet lines at the filter, using a $\frac{5}{8}$ -inch open-end wrench (figs. 195 and 196). Prime the filter by loosening vent valves on the filter and using the priming handle on the fuel pump; prime the filter until fuel is noticed coming out of the vent valves, after which valves should be tightened.

Section XXVIII

**BOSCH FUEL INJECTION SYSTEM
(BUDA DIESEL ENGINE)**

	Paragraph
General description	195
Fuel injection pump	196
Fuel injection timing	197
Governor	198
Check valve	199
Fuel transfer pump	200
Fuel nozzle and holder assembly	201
Fuel filters	202

195. GENERAL DESCRIPTION.

The fuel injection system of the Buda Diesel engine is similar in function and operation to that used on the Hercules Diesel engine. See section XXVII.

196. FUEL INJECTION PUMP.

a. Description and Operation. Refer to paragraph 189.

b. Removal of Fuel Injection Pump.

Wrench, open-end, $\frac{1}{8}$ -in. Wrench, open-end, $\frac{3}{4}$ -in.
Wrench, open-end, $\frac{5}{8}$ -in.

(1) Detach the fuel pump fuel inlet line at the top and front of the fuel injection pump ($\frac{3}{4}$ -in. open-end wrench). Detach the fuel pump fuel outlet line at the rear of the fuel injection pump ($\frac{5}{8}$ -in. open-end wrench).

(2) DETACH LEAK-OFF MANIFOLD FROM PUMP.

Wrench, open-end, $\frac{1}{8}$ -in.

Loosen and remove the fuel nozzle leak-off manifold from the union at the pump.

(3) REMOVE FUEL INJECTION PUMP.

Wrench, open-end, $\frac{1}{8}$ -in.

Remove pump by removing four bolts, washers, and nuts at the base of the pump.

c. Installation of Fuel Injection Pump.

Wrench, open-end, $\frac{1}{8}$ -in. Wrench, open-end, $\frac{3}{4}$ -in.
Wrench, open-end, $\frac{5}{8}$ -in.

SCOUT CAR M3A1

(1) INSTALL FUEL INJECTION PUMP.

Wrench, open-end, $\frac{3}{16}$ -in.

Place the pump on the side of the engine case. Install the four bolts, washers and nuts and tighten.

(2) CONNECT THE LEAK-OFF MANIFOLD TO THE PUMP.

Wrench, open-end, $\frac{3}{16}$ -in.

Connect the leak-off manifold at the union at the pump.

(3) ATTACH THE FUEL PUMP FUEL LINES AT THE PUMP.

Wrench, open-end, $\frac{5}{8}$ -in.

Wrench, open-end, $\frac{3}{4}$ -in.

Connect the fuel pump fuel inlet line at the top and front of the fuel injection pump ($\frac{3}{4}$ -in. open-end wrench). Connect the fuel pump fuel outlet line at the rear of the fuel injection pump ($\frac{5}{8}$ -in. open-end wrench).

197. FUEL INJECTION TIMING.

a. Explanation. Timing is done on No. 1 cylinder. The object is to have the piston in No. 1 cylinder at the specified number of degrees before top center on the compression stroke. The fuel pump is then turned so the fuel pressure pump is just ready to produce a hydraulic pressure to force fuel to the No. 1 cylinder injector.

b. Procedure.

(1) Completely disconnect the No. 1 cylinder fuel line (fig. 198).

(2) Remove the injector line clamp (fig. 198).

(3) Remove the line from the pump connection.

(4) Mark the location of one of the corners of the hexagon of No. 1 delivery valve holder on top of the fuel pump (fig. 199). This is important, because the delivery valve holder must be replaced in exactly the same position. Then remove the delivery valve holder.

(5) Lift out the delivery valve spring and valve. Wrap the two in a clean paper and put in a protected spot where they will be kept clean.

(6) Uncover the timing opening in the flywheel housing. Turn the flywheel in direction of rotation by means of the hand crank, and stop with the line under the No. 1 F.P.I. (fuel pump injection) centered in the timing hole. The fuel pump coupling should be in the position shown in figure 199. If not, turn the engine one complete revolution, until the No. 1 F.P.I. line is again centered in the opening.

(7) Install the No. 1 line as shown in figure 198.

(8) Connect the inlet of the fuel transfer pump to a source of supply of clean fuel with a temporary inlet, as indicated in figure 198.

(9) Loosen one end of the fuel transfer pressure control valve line.

BOSCH FUEL INJECTION SYSTEM (BUDA DIESEL ENGINE)

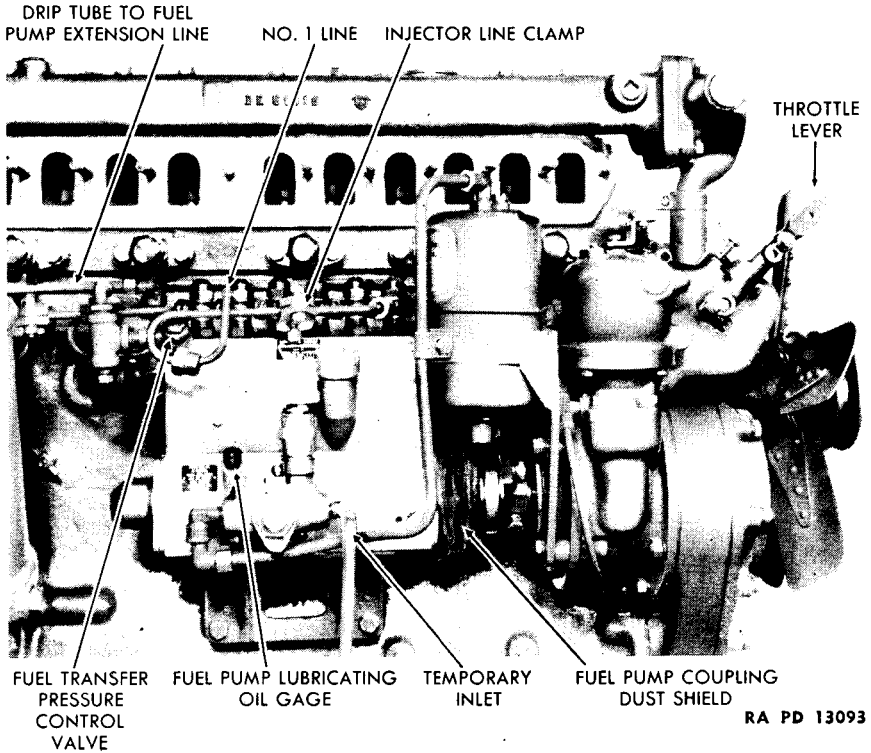

Figure 198 — Fuel Injection Timing - (Buda Diesel)

- (10) Loosen the two pump coupling lock screws $\frac{1}{3}$ turn each.
- (11) While holding the governor lever in the full speed position, use the transfer pump to build up a little fuel pressure (fig. 199).
- (12) Turn the fuel pump side of the coupling so the top of the coupling turns away from the engine. Turn until fuel flows freely through the No. 1 line.
- (13) Reverse the direction of turning, and find the position of the coupling where the fuel just stops flowing.
- (14) Tighten one coupling nut so the fuel pump will turn with the engine.
- (15) As a check, turn the engine about 25 degrees in the direction opposite to rotation.
- (16) Turn the engine in the direction of rotation to the place where fuel just stops flowing through the open fuel line. Observe the location of the timing line through the hole in the flywheel housing. If the tim-

SCOUT CAR M3A1

ing line is not centered, repeat the timing procedure until this condition is obtained.

(17) Again remove the No. 1 line.

(18) Install the check valve and spring.

(19) Turn the delivery valve holder hexagon back to the position where the hexagon is just tight (fig. 199). Turn the hexagon so it is in alinement with the mark on the fuel pump which was made before the delivery valve holder was removed.

(20) Install the No. 1 line.

(21) Put the injector line clamp back in position (fig. 198).

(22) Tighten the fuel transfer pressure control valve line.

(23) Remove the temporary fuel inlet line.

(24) Check both coupling bolts for tightness.

(25) Check the wire on the accessory end of the fuel pump coupling dust shield and wire the boot at the fuel pump end. Make sure the wires are in the grooves before tightening.

198. GOVERNOR.

The Pierce governor used is of the centrifugal (or flyball) type. It

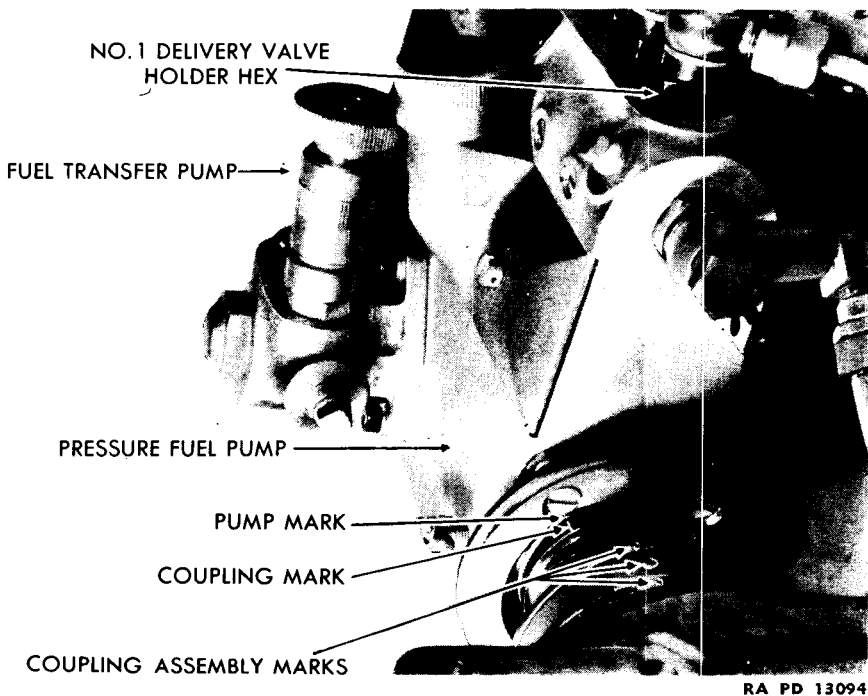

Figure 199 — Fuel Pump Coupling Marking - (Buda Diesel)

BOSCH FUEL INJECTION SYSTEM (BUDA DIESEL ENGINE)

is mounted on the fuel pump drive housing, and driven through spiral gears. It is of the variable-speed type which will permit close regulation from idle to full load speeds. Oiling is accomplished by means of a pressure lead from the main gallery line in the crankcase which supplies oil to all working parts. When the engine leaves the factory, the control stop on the fuel injection pump is set for the maximum fuel the engine will burn efficiently under full load and speed, and should *never be altered for any governor adjustment.*

199. CHECK VALVE.

a. Description. The check valve on the fuel outlet maintains a set pressure in the fuel manifold of the pump.

b. Removal.

Wrench, open-end, $\frac{1}{16}$ -in.

Wrench, open-end, $1\frac{1}{16}$ -in.

Wrench, open-end, $\frac{7}{8}$ -in.

Loosen the flared tube nut ($1\frac{1}{16}$ -in. open-end wrench) at the bottom of the check valve, beyond the elbow. Loosen the flared tube nut ($\frac{7}{8}$ -in. open-end wrench) at the top of the check valve. Remove the two $\frac{1}{4}$ -inch nuts, washers and bolts ($\frac{1}{16}$ -in. open-end wrench) that hold the check valve to the rear of the dash.

c. Maintenance. Should dirt or lint get between the valve and its seat, the valve will cease to function and the pressure in the manifold will be reduced with a resultant drop in engine power. Hold the valve open while washing it out with fuel oil, SOLVENT, dry-cleaning or gasoline. Do not completely disassemble the valve.

d. Installation.

Wrench, open-end, $\frac{1}{16}$ -in.

Wrench, open-end, $1\frac{1}{16}$ -in.

Wrench, open-end, $\frac{7}{8}$ -in.

Place vacuum check valve on rear of dash and insert bolts, washers and nuts ($\frac{1}{16}$ -in. open-end wrench) and tighten. Connect flared tube nut ($\frac{7}{8}$ -in. open-end wrench) at the top of check valve. Connect flared tube nut ($1\frac{1}{16}$ -in. open-end wrench) at the bottom of check valve.

200. FUEL TRANSFER PUMP.

Refer to paragraph 192.

201. FUEL NOZZLE AND HOLDER ASSEMBLY.

a. Description. Fuel is fed to the nozzle mouth, by means of small drilled passages, to a small reservoir just behind the nozzle seat. The nozzle pintle is kept on its seat by a spring which bears against it until a pressure of 1,650 pounds is delivered, which raises the pintle off its seat and allows the injection of fuel into the combustion chamber.

SCOUT CAR M3A1

b. Removal of Fuel Nozzle and Holder Assembly.

Screwdriver	Wrench, open-end, $\frac{5}{8}$ -in.
Wrench, open-end, $\frac{9}{16}$ -in.	Wrench, open-end, $\frac{3}{4}$ -in.

Disconnect the fuel pump inlet line ($\frac{3}{4}$ -in. open-end wrench) from the injector. Disconnect the fuel pump outlet line ($\frac{5}{8}$ -in open-end wrench) from the injector. Remove two nuts, lock washers and copper gasket ($\frac{9}{16}$ -in. open-end wrench), and remove assembly. If the engine has been in operation for a considerable length of time, it may be necessary to pry out the nozzle holder with a screwdriver, due to carbon deposits.

c. Installation of Fuel Nozzle and Holder Assembly.

Wrench, open-end, $\frac{9}{16}$ -in.	Wrench, open-end, $\frac{3}{4}$ -in.
Wrench, open-end, $\frac{5}{8}$ -in.	

Insert new copper gasket, and place the fuel nozzle in the opening in the side of the engine. Insert two nuts and lock washers, and tighten ($\frac{9}{16}$ -in. open-end wrench). Connect the fuel pump outlet line ($\frac{5}{8}$ -in open-end wrench) to the injector. Connect the fuel pump inlet line ($\frac{3}{4}$ -in. open-end wrench) to the injector.

202. FUEL FILTERS.

a. Description. Two separate stages of filtration are provided for the protection of the engine. The secondary filter is a sealed unit which does not have replaceable elements. The Purolator or primary filter combines two stages of filtration in the single unit. Refer to section XXVII, paragraph 194, for this type of filter.

b. Maintenance of Secondary Filter. To maintain trouble-free, dependable, uninterrupted service, clean fuel is essential. Periodically unscrew the plug at the bottom to drain sludge and water. After draining, unscrew the plug at the top to bleed the air, operating the hand priming pump device on the transfer pump until the fuel flows in a solid stream without signs of air bubbles. Replace after 12,000 miles of service, or if during engine operation, a loss of fuel pressure indicates a clogged filter.

c. Removal and Installation. Remove the inlet and outlet lines, and nut and bolt holding the filter in place. To install, place filter in position, install bolt and nut holding filter to bracket, and connect inlet and outlet lines.

Section XXIX

INSTRUMENTS AND GAGES

	Paragraph
Instrument cluster	203
Speedometer	204
Voltmeter	205

203. INSTRUMENT CLUSTER.

a. **Description.** The four-unit instrument cluster includes an ammeter, fuel gage, lubricating oil pressure gage, and water temperature gage (fig. 200).

b. **Ammeter.** The electro-magnetic type ammeter is graduated to read from minus 100 to plus 100 amperes. Readings toward the minus sign indicate total current discharge of the battery. Readings toward

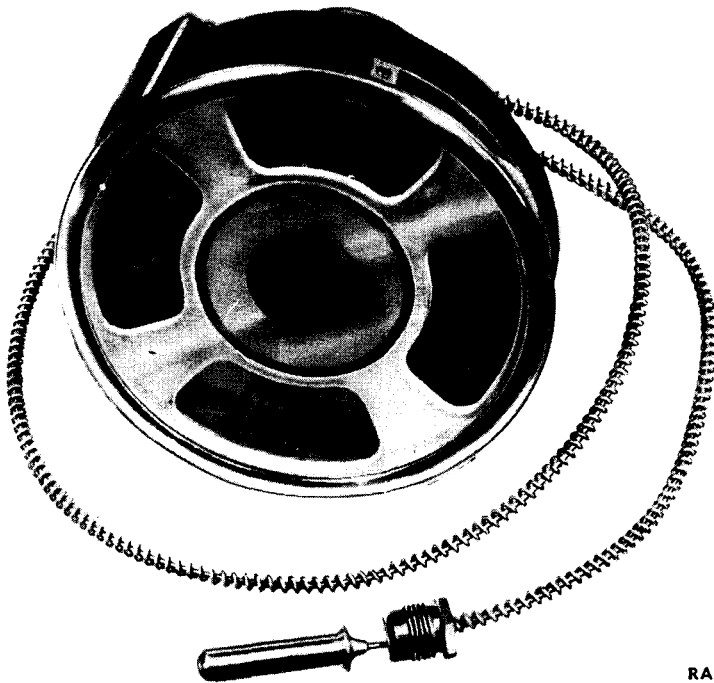

RA PD 6217

Figure 200 — Instrument Cluster Assembly - Front View

SCOUT CAR M3A1

the plus sign indicate the net current input to the battery. The total output of the generator is not indicated by the ammeter readings.

c. **Fuel Gage.** The graduations on the dash unit are in the range "Empty— $\frac{1}{4}$ — $\frac{1}{2}$ — $\frac{3}{4}$ —Full." A transfer switch permits checking (on one gage) the amount of fuel in either tank (fig. 6). The ignition switch must be on before any reading can be taken.

d. **Water Temperature Gage.** The heat indicator is graduated to read 100—180—220 degrees F. Normal operating temperature is 160 F.

e. **Oil Pressure Gage.** The gage is graduated in the range 0—40—80 pounds. With a warm engine, the normal operating range is from 30 to 35 pounds.

f. **Cluster Removal** (fig. 201). Disconnect wires at ammeter and fuel gage; remove ignition switch condenser; disconnect oil line from gage; disconnect heat indicator bulb adapter at engine with a $\frac{5}{8}$ -inch open-end wrench; loosen and remove two L-clamp bracket stud nuts with a

$\frac{3}{8}$ -inch open-end wrench; remove cluster to the front. NOTE: The heat

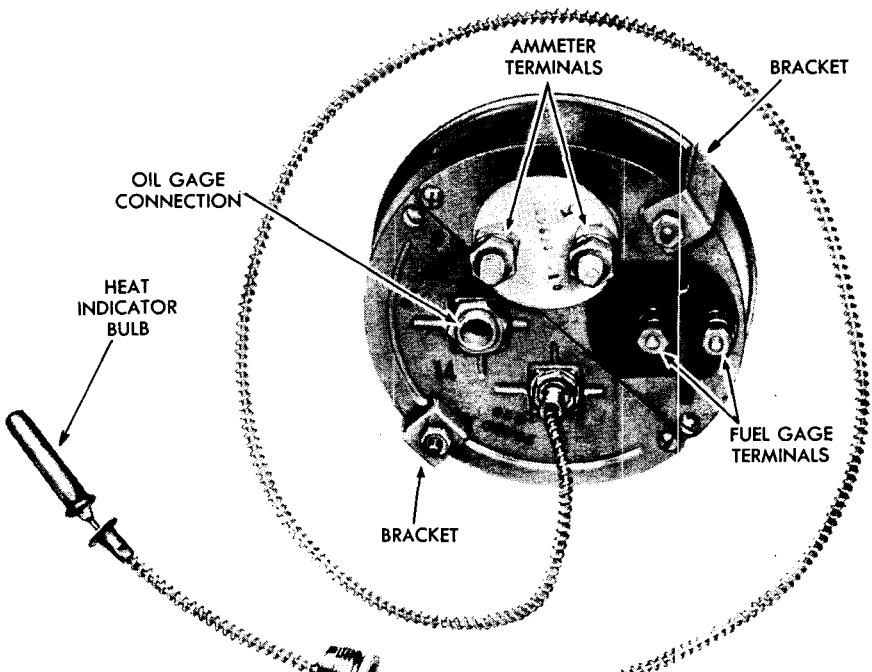

INSTRUMENTS AND GAGES

indicator bulb adapter is located at the left rear corner of cylinder head for the gasoline engine, on the water manifold for the Hercules Diesel, and the right top side of the cylinder head water outlet for the Buda Diesel.

204. SPEEDOMETER (fig. 202).

a. **Description.** The dial-type speedometer reads from 0 to 80 miles per hour. Total mileage of 99,999 miles, and trip miles from 0 to 999 are also recorded. The speedometer is driven by a flexible drive shaft which is connected to the driving mechanism in the transfer case.

b. **Removal.** Loosen and remove lamp bracket attaching screw with a small screwdriver; disconnect flexible drive shaft coupling at speedometer; loosen and remove two stud nuts with a $\frac{3}{8}$ -inch open-end wrench; remove instrument to front (fig. 203).

c. **Installation.** Place speedometer in position and install two stud nuts with a $\frac{3}{8}$ -inch open-end wrench; connect the flexible drive shaft at the speedometer; install lamp bracket attaching screw with a screwdriver (fig. 203).

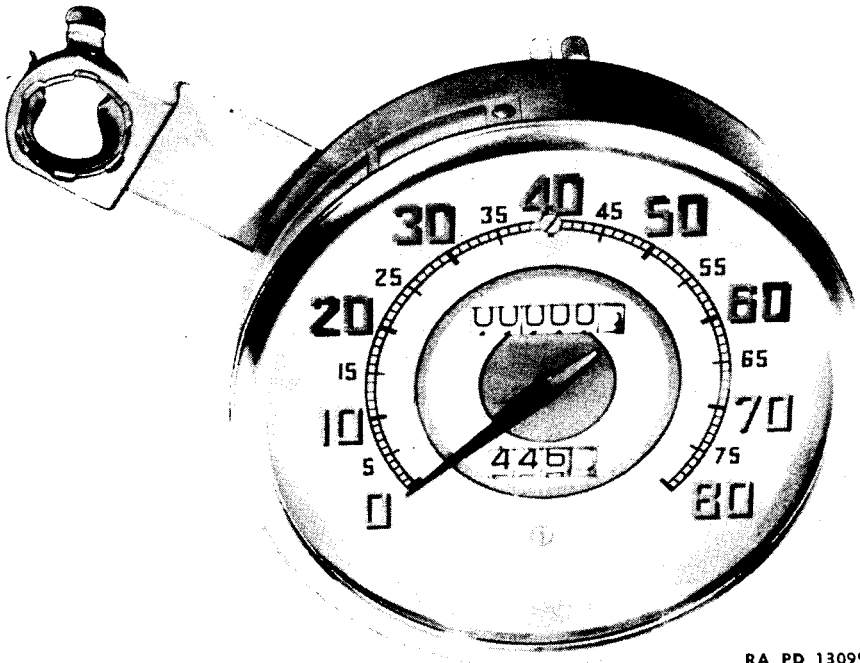

RA PD 13099

Figure 202 — Speedometer Assembly - Front View

SCOUT CAR M3A1

205. VOLTMETER.

a. **Description.** The voltmeter is graduated to read from 0 to 20 volts direct-current when connected to the circuit by a switch.

b. **Removal.** Disconnect wires; loosen and remove three mounting screws; remove meter to the rear.

c. **Installation.** Place the meter in position and install the three mounting screws; connect the wires.

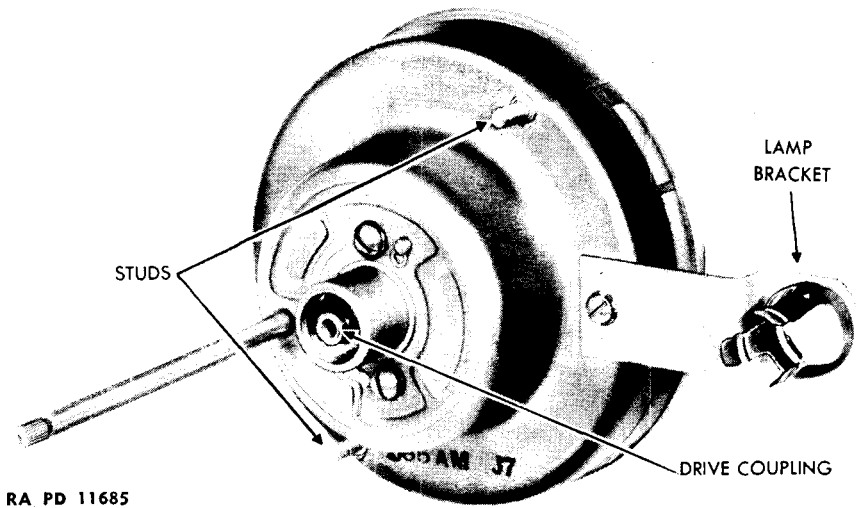

RA PD 11685

Figure 203 — Speedometer Assembly - Rear View

Section XXX

PROPELLER SHAFTS

	Paragraph
Description	206
Maintenance	207
Unit replacement	208

206. DESCRIPTION.

Power is transmitted from the transmission to the transfer case and then to the front and rear axles by means of three propeller shafts equipped with universal joints. The longest shaft is located between the transfer case and front axles; the medium length shaft between the transfer case and rear axle; and the shortest shaft as a coupling between the transfer case and transmission. The short main propeller shaft coupling between the transmission and transfer case incorporates a ball yoke universal assembly and splined shaft, a sleeve yoke universal assembly, yoke flanges, and companion flanges for the transmission and transfer case respectively. Arrows on the propeller shaft yokes must be in line to aline yokes. The two longer propeller shafts to the axles incorporate a tube assembly with a universal sleeve joint assembly at the splined end, and a universal joint assembly at the yoke end. Beyond the universal joints are the flanges that serve to connect the transfer case and the respective axles. Arrows on the propeller shaft yokes must be in line to aline yokes.

207. MAINTENANCE.

Inspect all universal joints for wear and defective grease seals. Replace bent or damaged shafts. Replace the slip joint members when there is sufficient clearance to cause propeller shaft run-out and vibration.

208. UNIT REPLACEMENT.

a. General. Dropping respective propeller shafts permits removal of the transmission and transfer case, front or rear axle without disturbing the unit assembly at the other end of the shaft. A new shaft should be installed in case of breakage. Welding of a broken shaft in the field is not recommended. Install flange bolts with new lock washers or cotter pins and draw up nuts alternately and evenly.

b. Propeller Shaft to Front Axle Replacement.

Wrench, open-end, $\frac{5}{8}$ -in.

Remove the four bolts, nuts and lock washers which secure each universal joint to the companion flange; lower shaft assembly to the floor. Install by placing the shaft in position and installing the bolts, lock washers and nuts.

SCOUT CAR M3A1

c. Propeller Shaft to Rear Axle Replacement.

Wrench, open-end, $\frac{5}{8}$ -in.

Remove the four bolts, nuts and lock washers which secure each universal joint to the companion flange; lower shaft assembly to the floor. Install by placing the shaft in position and installing the bolts, lock washers and nuts.

d. Transmission to Transfer Case Propeller Shaft Replacement.

Wrench, open-end, $\frac{5}{8}$ -in.

Remove the four bolts, lock washers and nuts which secure the universal joint to transmission and transfer case companion flanges; lower the shaft to the floor. Install by placing the shaft in position and installing the bolts, lock washers and nuts.

Section XXXI

SPRINGS AND SHOCK ABSORBERS

	Paragraph
Description	209
Trouble shooting	210
Maintenance and adjustments.....	211
Removal and installation of springs.....	212
Removal and installation of shock absorbers.....	213

209. DESCRIPTION (figs. 204 and 205).

a. Springs.

(1) Semielliptic springs are used for the front and rear axles. They are anchored at the front end and shackled at the rear.

(2) Two springs are used to suspend the vehicle on the front axle. Two types of front springs are in current use. The early type front spring was constructed so that a joint was formed between the center section and the outer section of the third leaf. The appearance of this joint gives the impression of a broken spring leaf. The later type spring is constructed so that the three top leaves wrap about the shackle pin bushing and the center section of the top leaf is articulated with the two intersections.

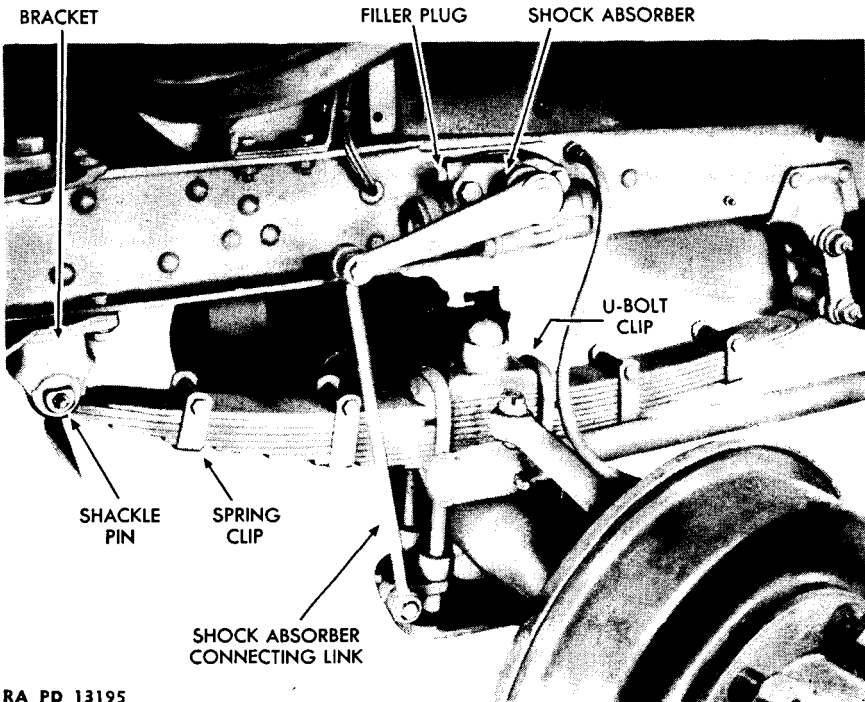

RA PD 13195

Figure 204 — Front Spring and Shock Absorber - Installed

SCOUT CAR M3A1

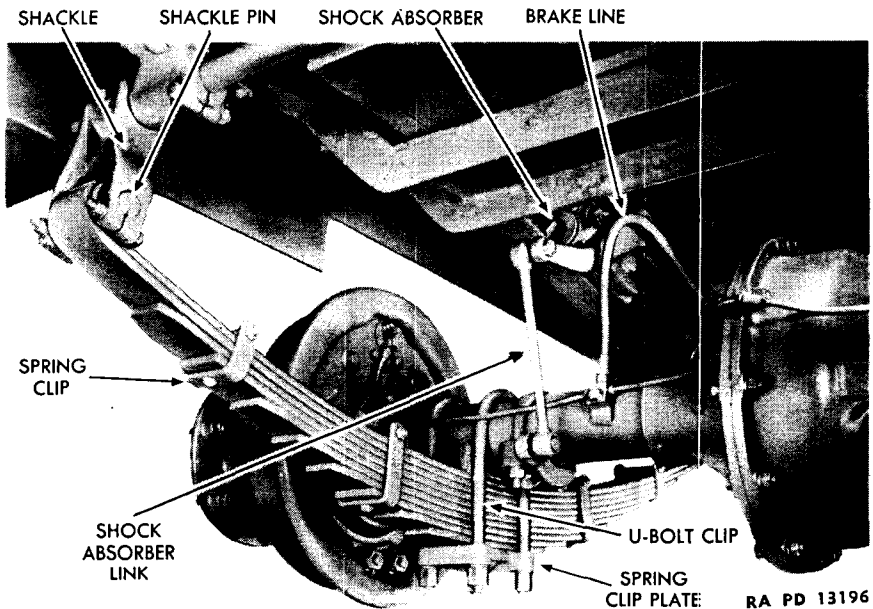

Figure 205 — Rear Spring and Shock Absorber - Installed

b. **Shock Absorbers** (figs. 204 and 205). Double-acting shock absorbers are used to control the action of the springs. The shock absorber mechanism is bolted to the vehicle frame above the springs, the upper end of each connecting link being held to the piston operating arm by a special bolt and nut. The lower ends of the front shock absorber connecting links are attached to the spring U-bolt clips at the bottom of the front axle spring seats by means of a bracket. The rear connecting links are attached, by means of brackets, to clips fastened to the rear axle.

210. TROUBLE SHOOTING.

Defects in the springs during operation of the vehicle can cause hard riding, excess flexibility, or excessive noises.

a. **Hard Riding.** Insufficient lubrication, broken shackle pins, broken bracket bolts, overloading or uneven load distribution are possible causes of hard riding.

b. **Excess Flexibility.** Broken spring leaves, lack of fluid in the shock absorbers or improper action of the shock absorber will cause this condition.

c. **Excessive Noises.** During operation of the vehicle, worn bolts, pins and bushings in the shackles and brackets, loose spring clips or broken leaves cause excessively noisy operation.

SPRINGS AND SHOCK ABSORBERS

211. MAINTENANCE AND ADJUSTMENTS.

a. **Springs.** The spring clips which fasten the springs to the axles should be examined regularly and kept tight. Loose spring clips allow the shaft to shift and cause leaf breakage and improper alinement of the wheels. The springs should be inspected for broken plates and missing clips. They should be checked for any evidence of settling or overloading of the spring, indicated by flattened or missing rubber bumpers. A check should also be made for binding in the shackles.

b. **Shock Absorbers.** Adjustments, made at the factory to establish shock absorber resistance, should not be changed.

212. REMOVAL AND INSTALLATION OF SPRINGS (figs. 204 and 205).

a. Replacement of Front Spring.

Hammer	Punch
Jack (two)	Wrench, socket, $\frac{1}{8}$ -in.
Pliers	

(1) REMOVAL.

Hammer	Punch
Jack (two)	Wrench, socket, $\frac{1}{8}$ -in.
Pliers	

Jack up vehicle at frame. Remove the hexagon nuts which hold U-bolt spring clips, shock absorber connecting link bracket and rubber-padded block. Remove the cotter pins and the special slotted nuts from the spring shackle pins. Drive out the shackle pins and lift out the front spring.

(2) INSTALLATION.

Hammer	Punch
Jack (two)	Wrench, socket, $\frac{1}{8}$ -in.
Pliers	

Place spring in position on front axle. Insert shackle pins and secure with special slotted nuts and cotter pin. Lower jack until spring rests solidly on front axle with spring center bolt head in position on axle. Place rubber-padded block in position on spring and install U-bolt clips. Place shock absorber connecting link bracket in position on front of U-bolt clip and secure clips with lock washers and nuts. Remove jack.

b. Replacement of Rear Spring.

Hammer	Wrench, open-end, $\frac{9}{16}$ -in.
Jack (two)	Wrench, socket, $\frac{1}{8}$ -in.
Punch	

SCOUT CAR M3A1

(1) REMOVAL.

Hammer	Wrench, open-end, $\frac{1}{8}$ -in.
Jack (two)	Wrench, socket, $\frac{1}{8}$ -in.
Punch	

Jack up vehicle at frame until spring is relieved of the load. Remove four hexagon nuts and lock washers. Remove rear spring U-bolt clips and plate. Remove nuts and lock washers from cap screws securing shackle pins, and drive out cap screws with thin punch. With a jack in position under center of spring to keep spring from dropping, remove the two shackle pins and lift out spring.

(2) INSTALLATION.

Hammer	Wrench, open-end, $\frac{1}{8}$ -in.
Jack (two)	Wrench, socket, $\frac{1}{8}$ -in.
Punch	

Place rear spring under rear axle and install front and rear shackle pins. Secure pins with cap screws, nuts and lock washers. Jack up spring to rear axle, so that center bolt nut rests in position. Place spring U-bolt clips and spring clip plate in position and secure with nuts and lock washers. Remove jacks.

213. REMOVAL AND INSTALLATION OF SHOCK ABSORBERS.

Hammer, soft metal	Wrench, socket, $\frac{3}{4}$ -in.
Wrench, open-end, $\frac{1}{8}$ -in.	Wrench, socket, $\frac{1}{8}$ -in.

a. Removal.

Hammer, soft metal	Wrench, socket, $\frac{3}{4}$ -in.
Wrench, open-end, $\frac{1}{8}$ -in.	Wrench, socket, $\frac{1}{8}$ -in.

Remove nut and drive out the bolt holding lower end of connecting link to bracket. Remove two nuts, lock washers and screws holding each assembly to frame and lower assembly.

b. Installation.

Hammer, soft metal	Wrench, socket, $\frac{3}{4}$ -in.
Wrench, open-end, $\frac{1}{8}$ -in.	Wrench, socket, $\frac{1}{8}$ -in.

Hold assembly in position and replace holding screws, lock washers and nuts. Tap bolt through lower end of connecting link and bracket and replace holding nut.

Section XXXII

STEERING GEAR

	Paragraph
Description	214
Trouble shooting	215
Maintenance and adjustments.....	216
Replacement of components.....	217

214. DESCRIPTION.

a. Steering Gear (fig. 206). The steering gear is of the cam and twin-lever type. The case is bracket-mounted to the frame, and the column is supported by a rubber bushing in the dash bracket. The cam, lever and shaft are mounted in an oil-tight case, with full provision for adjustment of both the cam and cam follower.

b. Drag Link (fig. 207). The drag link is of the tubular type, with adjustable ball sockets which are spring-loaded. At the axle end, the spring and spacer are assembled between the ball seat and rod end (bottom of socket), while at the steering gear end, the spring and spacer are between the ball seat and the end plug.

c. Steering Wheel. The steering wheel is of the three-spoke type and is 18 inches in diameter.

215. TROUBLE SHOOTING.

a. Steering Difficulties.

(1) **SHIMMY.** Shimmy is an excessive vibration of the front wheels from side to side, or up and down, causing a jerking motion of the steering wheel. Low-speed shimmy occurs at speeds less than 30 miles an hour, and is usually caused by excessive caster or excessive looseness in any part of the system. High-speed shimmy usually occurs at speeds above 35 miles an hour and may be caused by low or unequal tire pressures, unbalanced front wheels, improperly acting shock absorbers, too flexible springs, loose wheels or steering connections, or incorrect toe-in. Shimmy which develops after lubrication of the steering system and steering gear, indicates that parts should be checked for wear or looseness.

(2) **SIDE PULL.** The most common causes of vehicle side-pulling are unequal camber, unequal caster, unequal tire inflation, dragging brakes, tight wheel bearings, or improper tracking.

(3) **WANDER OR WEAVING.** Swinging of the vehicle to one side of the road may be caused by insufficient or reversed caster; or it may be due to excessive tightness in any part of the steering system that overcomes the steadying effect of caster, causing the driver to steer first to one side and then to the other.

SCOUT CAR M3A1

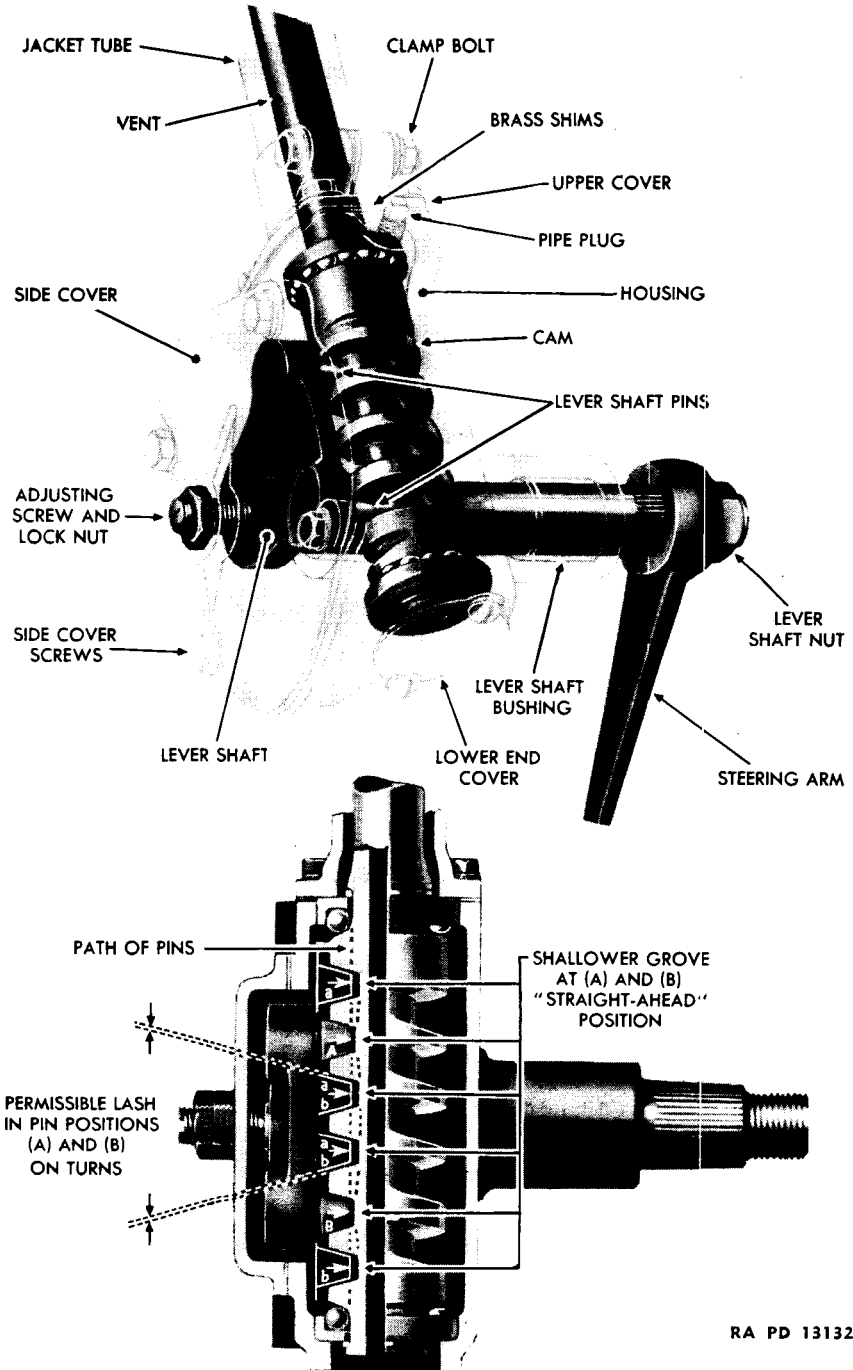

RA PD 13132

STEERING GEAR

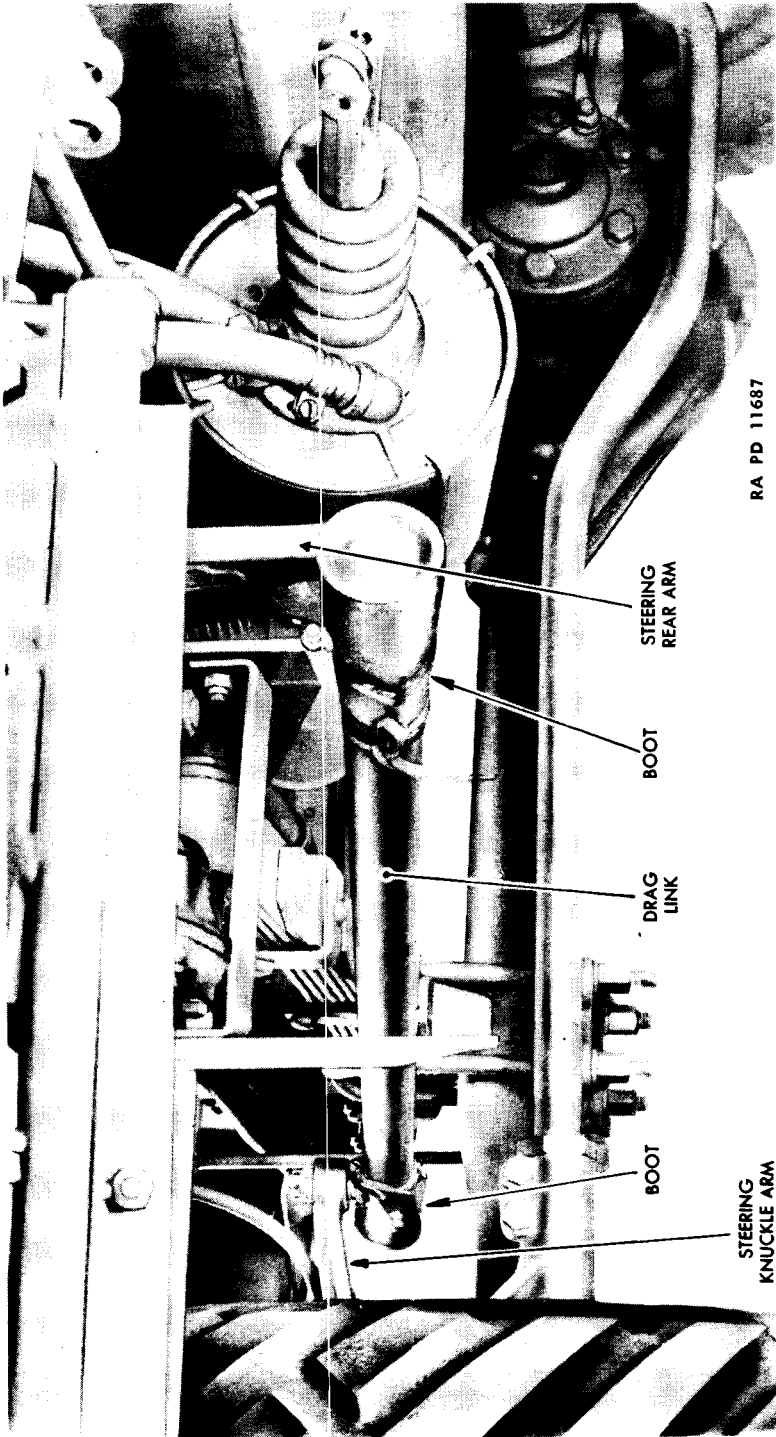

RA PD 11687

Figure 207 — Steering Drag Link - Installed

SCOUT CAR M3A1

(4) **HARD STEERING.** Difficulty in steering around turns develops from excessive caster, improper or unequal camber, twisted axle, excessive tightness in the steering system, low or unequal tire pressure.

(5) **ROAD SHOCK.** Road shocks are sometimes felt on the steering wheel when driving over rough roads, and may induce shimmy. They are caused by misaligned drag link, excessive spring flexibility, or improper adjustment of the shock absorbers.

b. Steering Trouble Remedies. The various means employed to correct steering troubles may be classified as:

- (1) Correct troubles in the steering gear.
- (2) Correct looseness in the steering system.
- (3) Correct tightness in the steering system.
- (4) Maintenance and adjustment of wheel bearings.
- (5) Correct misalignment of wheels.
- (6) Correct broken or shifted front springs.

c. Procedure. To locate the general source of trouble, disconnect the drag link from the steering gear arm (fig. 207). Then, if any difficulty is encountered in spinning the steering wheel with one finger, or if end play of the steering gear cam and tube or lever shaft is found, the trouble may be assumed to be in the steering system. However, wheel alignment, wheel bearing adjustment, steering knuckle adjustment, and tire inflation should also be checked. See section XI.

216. MAINTENANCE AND ADJUSTMENTS.

When making adjustments, first disconnect the drag link from the steering gear arm and loosen the instrument panel bracket which holds the steering gear jacket tube in place. Then follow the specific instructions indicated below, and in the order given.

a. Loosen the steering gear housing side cover adjusting screw and lock nut to free the pins in the cam groove (fig. 208).

b. Remove the four upper cover screws and raise the cover about $\frac{3}{4}$ inch to permit the removal of the shims. A combination of 0.003-inch, 0.010-inch and 0.030-inch shims is used between paper gaskets (fig. 209).

c. Clip and remove one 0.003-inch shim, or more as required. Replace cover and tighten screws.

d. Adjust side cover adjusting screw (fig. 208) to a barely perceptible drag so the steering wheel can be turned freely.

e. Reclamp the steering column jacket tube, and test the turning freedom again to insure that no binding has been introduced. Make sure that the steering ball arm is tight on the splined shaft and that the lock washer and nut are also tight.

STEERING GEAR

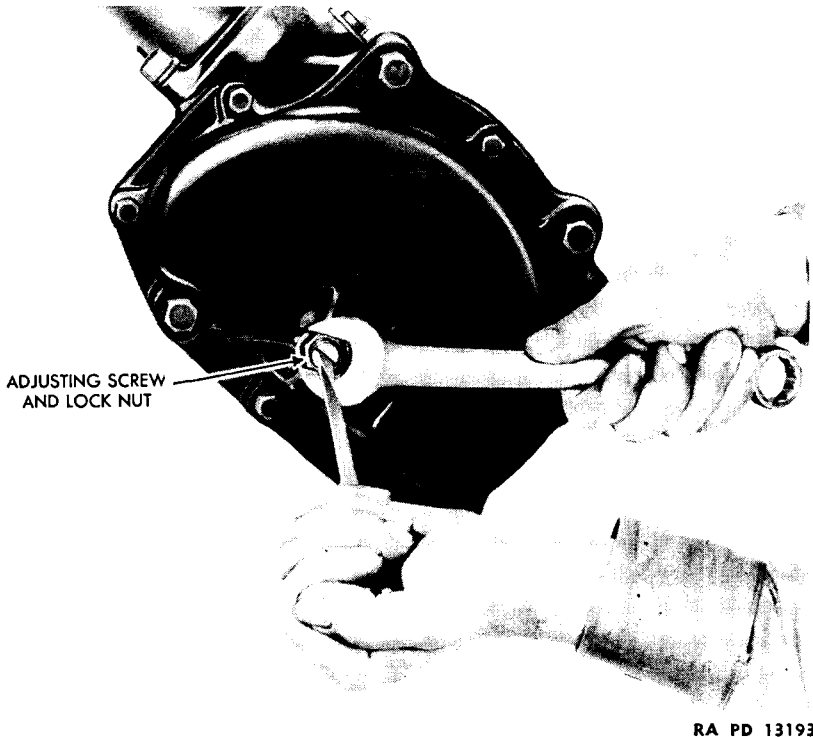

RA PD 13193

Figure 208 — Loosening Adjusting Screw and Lock Nut

f. Tighten the side cover adjusting screw while the steering wheel is turned slowly from extreme left to extreme right, until a very slight drag is felt on the steering wheel in the straight-ahead steering position. **CAUTION:** The gear must not bind at any place; only a very slight drag should be felt. A closer adjustment will not correct any steering condition, but will damage and wear the steering gear parts and impair operation.

g. Locate the center of the steering wheel drag and set the steering wheel in that central position, making an appropriate scratch mark on the wheel, so that this position can be quickly and accurately resumed after any turning of the steering wheel (approx. $2\frac{1}{2}$ turns of steering wheel from either the extreme right or extreme left position of the steering wheel).

h. Locate the straight-ahead position of the front wheels by using a chalk line and lining the front wheels with the rear wheels, making due allowance for the toe-in of the front wheels.

i. Install the drag link, noting the amount the steering wheel must be turned to permit replacing the drag link. Adjust the rear ball socket

SCOUT CAR M3A1

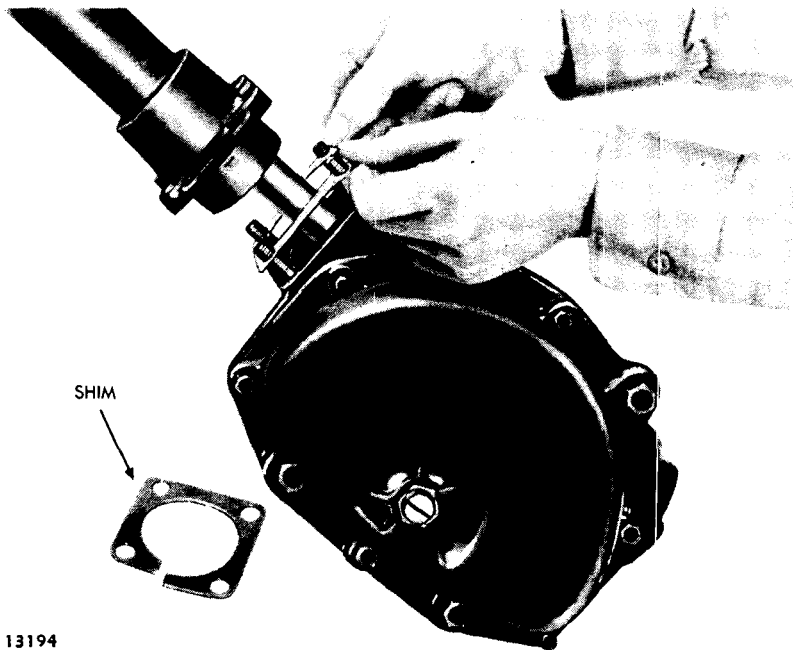

RA PD 13194

RA PD 13194

Figure 209 — Steering Gear End Play Adjustment

to permit the return of the steering wheel to the central drag position. If it is found necessary, the steering arm and ball assembly may be removed and its position changed on the splined shaft in order to permit installing the drag link.

j. **CAUTION:** Do not attempt to cure wander, shimmy or road shock by tightening the steering gear. Adjust the steering gear only to remove play in it.

217. REPLACEMENT OF COMPONENTS.

a. **Horn Button Removal.** Disconnect horn button cable terminal at the bottom of the steering gear housing. Depress button and rotate $\frac{1}{6}$ of a turn to the left. The entire assembly may now be removed from the steering wheel. Pull cable through from steering wheel end.

b. **Horn Button Installation.** Insert the cable through the steering column from the steering wheel end. Place the button in position and depress it, rotating it $\frac{1}{6}$ of a turn to the right. Connect the horn button cable terminal at the bottom of the steering gear housing.

STEERING GEAR

c. Steering Wheel Removal.

Puller, steering wheel
Screwdriver

Wrench, socket, 1¼-in.

Take out three wood screws from horn button base plate and remove plate. Remove steering wheel nut from steering wheel tube. Using a steering wheel puller, remove steering wheel and Woodruff key.

d. Steering Wheel Installation.

Screwdriver

Wrench, socket, 1¼-in.

Insert the Woodruff key and place the steering wheel over it on the column. Install the steering wheel nut. Secure the horn button base plate in position with the three wood screws.

e. Drag Link Removal (fig. 204).

Adjuster, drag link

Pliers

Remove boots from drag link at both steering gear and steering knuckle ends. Remove cotter pins at both ends. Using a drag link adjuster, remove drag link plugs. Remove drag link from balls.

f. Installation of Drag Link.

Adjuster, drag link

Screwdriver, wide

(1) REPLACE LINK.

Adjuster, drag link

Screwdriver, wide

Set steering gear in mid-position for straight-ahead driving. Place wheels in straight-ahead driving position and slip drag link into steering gear and axle steering arm bolts. Turn up end plugs.

(2) DRAG LINK ADJUSTMENT.

Adjuster, drag link

Screwdriver, wide

Pliers

The only adjustment possible on the drag link is the adjustment of the end plugs. This is made after the link has been installed on the car. Using a drag link adjuster, tighten up the plugs just tight enough to prevent excessive looseness of the steering arm ball in the ball seats, but not tight enough to cause binding. Back off enough to enable cotter pins to be inserted in the drag link tube and end plugs to secure the plugs in position.

g. Steering Gear Removal.

Wrench, open-end, ½-in.

Wrench, open-end, ⅞-in.

Wrench, open-end, ¾-in.

Remove the brake and clutch pedal pull-back springs from the hook on the steering gear housing. Remove U-bolt from adjustable support at instrument panel. Remove the ½-inch bolt which secures the steering

SCOUT CAR M3A1

gear housing to the frame bracket. Remove two $\frac{9}{16}$ -inch hexagon nuts which hold the steering gear frame bracket cap. Remove the cap. Remove the steering gear assembly by lowering it toward the floor. Care should be taken not to bend or jar the steering jacket tube.

h. Steering Gear Installation.

Wrench, open-end, $\frac{1}{2}$ -in.

Wrench, open-end, $\frac{7}{8}$ -in.

Wrench, open-end, $\frac{3}{4}$ -in.

Place the steering gear in position and install the steering gear frame bracket cap and the two hexagon nuts to hold it. Install the $\frac{1}{2}$ -inch bolt which secures the steering gear housing to the frame bracket. Install the U-bolt at the adjustable support at the instrument panel. Secure the brake and clutch pedal pull-back springs to the hook washer on the steering gear housing.

Section XXXIII

TRANSFER CASE

	Paragraph
Description	218
Trouble shooting.....	219
Removal	220
Installation	221

218. DESCRIPTION (fig. 210).

The transfer case, or auxiliary transmission, is mounted in rubber to the rear of the transmission on a special cross member of the chassis. It is the unit through which the front and rear axles are driven and provides an additional speed reduction for any selection of the transmission gear speeds. The speedometer drive gear is on the idler shaft and fully enclosed in a small housing.

219. TROUBLE SHOOTING.

a. **General.** Frequent inspection of the transfer case lubricant level and gaskets, to insure against lubricant leakage, is the major service requirement. The bolts holding the transfer case may become loose, by

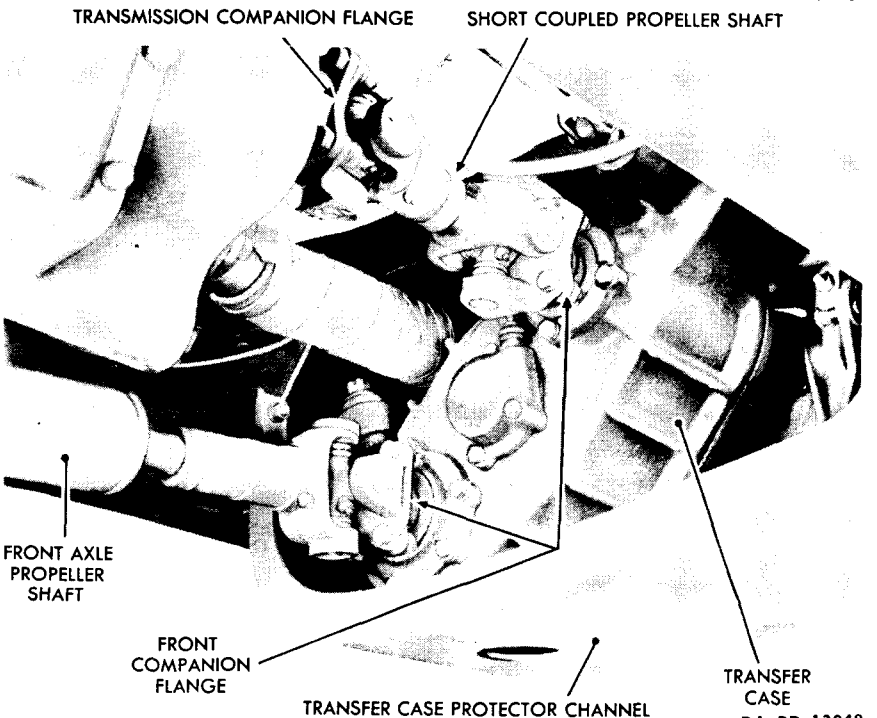

Figure 210 — Transfer Case, Installed

SCOUT CAR M3A1

reason of the rubber mounting insulator taking a permanent set. These bolts should be checked regularly (at least once a week) and adjusted tightly at all times in order to avoid failures.

b. **Noises.** Peculiar noises or foreign sounds which seem to come from the transfer case may actually originate in some other part of the power train. A thorough check, by actual driving, should be made to determine the real source of the noise before any mechanical work is initiated on the transfer case. Attention should be directed especially to the propeller shaft universal joints. Difficulties in the transfer case may be created, however, by reason of the following:

- (1) Improper or insufficient lubrication.
- (2) Stripped gears.
- (3) Worn bearings.
- (4) Excessive gear lash resulting from worn teeth
- (5) Loose gears.
- (6) Loose gaskets.
- (7) Installation out of line.

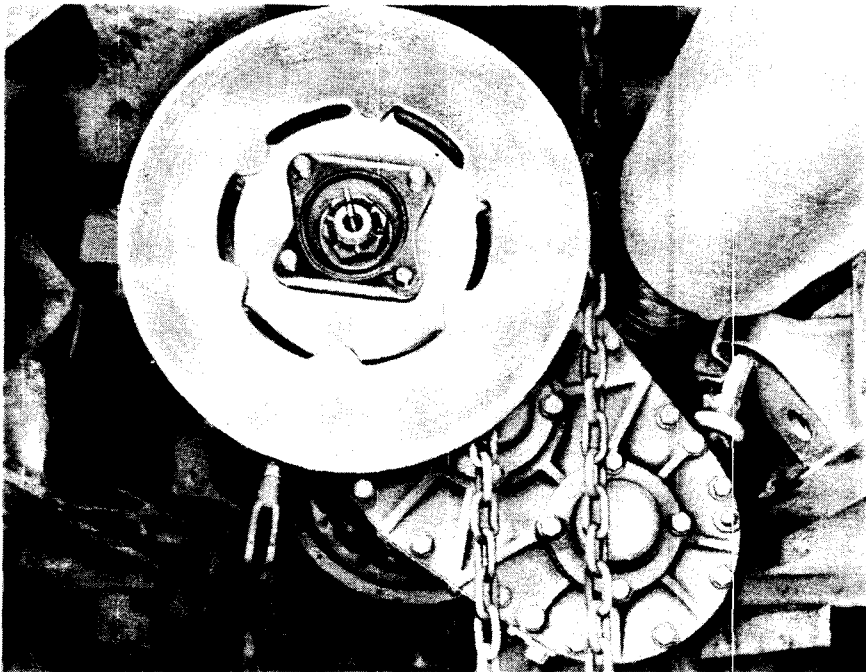

RA PD 13184

Figure 211 — Transfer Case Removal

TRANSFER CASE

220. REMOVAL (figs. 210 and 211).

Block, chain, and hook	Wrench, box, $\frac{1}{8}$ -in.
Hammer	Wrench, open-end, $\frac{5}{8}$ -in.
Pail	Wrench, open-end, $\frac{3}{4}$ -in.
Pliers	Wrench, open-end, $\frac{1}{8}$ -in.
Rope, 1-in.	Wrench, socket, $\frac{5}{8}$ -in.

- a. Drain the transfer case; remove the floor plates.
- b. Remove the protector channel under the transfer case by removing eight cap screws, nuts and lock washers, using $\frac{5}{8}$ -inch open-end and socket wrenches.
- c. Disconnect the transmission short coupled propeller shaft by removing the four bolts, nuts and lock washers that hold the propeller shaft to the transfer case companion flange. Use $\frac{5}{8}$ -inch socket and open-end wrenches.
- d. Disconnect the front and rear axle propeller shafts. Using $\frac{5}{8}$ -inch socket and open-end wrenches, remove the four bolts holding the rear axle shaft, four bolts holding front axle shaft, and eight nuts and lock washers holding shafts to their respective companion flanges.
- e. Place a sling around the transfer case assembly, making sure that it will be balanced when lowered (fig. 211). (In place of the sling, hand jacks may be placed under the transfer case and the transfer case lowered for removal from the bottom.)
- f. Remove the drive shaft brake assembly by removing the three cap screws and lock washers that hold the shaft brake bracket to the cross member ($\frac{3}{4}$ -in. open-end wrench).
- g. Disconnect the speedometer drive shaft from the idler shaft front bearing cap (pliers).
- h. Disconnect the shift rod yoke from the shift shaft by removing the cotter pin and the rod end pin (pliers and hammer).
- i. Cut the locking wire from four nuts on the transfer case mounting studs, and remove the nuts ($\frac{1}{8}$ -in. box and open-end wrenches). Lift out the assembly and lower it to the ground by means of the sling and the chain block. Then remove the four insulators, four rubber bushings, and the plain washers, from the mounting studs.

221. INSTALLATION.

Block, chain, and hook.	Wrench, open-end, $\frac{5}{8}$ -in.
Hammer	Wrench, open-end, $\frac{3}{4}$ -in.
Pliers	Wrench, open-end, $\frac{1}{8}$ -in.
Rope, 1-in.	Wrench, socket, $\frac{5}{8}$ -in.
Wrench, box, $\frac{1}{8}$ -in.	

SCOUT CAR M3A1

a. Slide the assembly under the vehicle and place sling around case. Lift into position, with mounting studs passing through holes in frame (fig. 211). Install eight washers, eight insulators, and four rubber bushings on the mounting studs, and install four mounting nuts and locking wire ($\frac{1}{8}$ -in. box and open-end wrenches).

b. Install the drive shaft brake assembly, securing it to the cross member by the three cap screws and lock washers ($\frac{3}{4}$ -in. open-end wrench).

c. Connect front and rear axle propeller shafts (fig. 210), installing the four bolts, nuts and lock washers that hold each propeller shaft to its companion flange ($\frac{5}{8}$ -in. socket and open-end wrenches).

d. Connect transmission propeller shaft, installing the four bolts and lock washers which hold the shaft to the companion flange ($\frac{5}{8}$ -in. open-end and box wrenches).

e. Using pliers, connect the speedometer drive shaft to the idler shaft front bearing cup.

f. Connect the gearshift lever, installing the rod end pin and cotter pin to hold the yoke to the shift shaft.

g. Install the protector channel under the transfer case, securing it by the four cap screws and lock washers ($\frac{5}{8}$ -in. socket and open-end wrenches).

h. Replace the floor plates.

i. Fill the transfer case with lubricant.

Section XXXIV
TRANSMISSION

	Paragraph
Description	222
Trouble shooting	223
Removal	224
Installation	225

222. DESCRIPTION (figs. 212 and 213).

The transmission is a combination sliding and constant-mesh unit having both helical and spur gears. First and second speeds are sliding mesh, while third and fourth speeds are of the constant-mesh type. Power is received by the transmission from the engine through the clutch, transmitted through the transmission to the short coupled shaft connecting the transmission to the transfer case.

223. TROUBLE SHOOTING.

a. **General.** The most common abuse to which a transmission is likely to be subjected is the inexperienced shifting of gears, which causes broken shifting levers, forks, springs and shafts. Frequent inspection of the

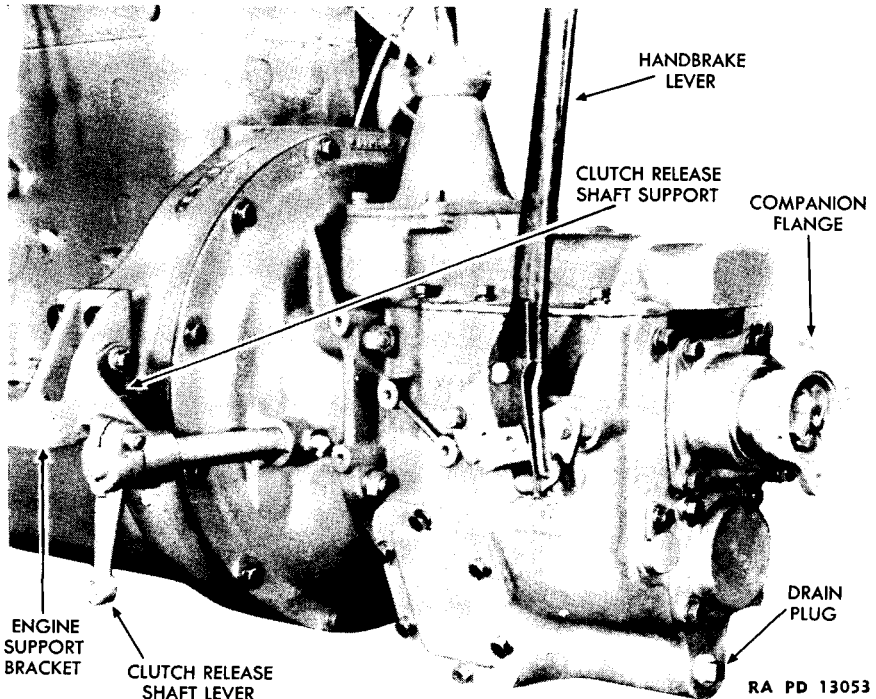

Figure 212 — Transmission, Installed

SCOUT CAR M3A1

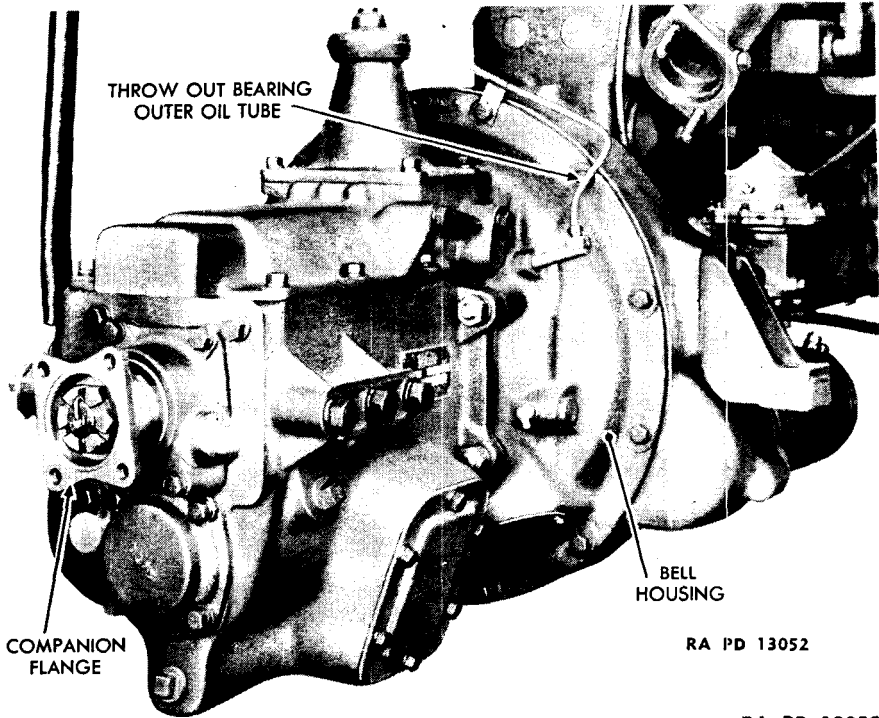

Figure 213 — Transmission, Installed

lubricant level and the gaskets, to insure against lubricant leakage, is the major service requirement.

b. **Noises.** Peculiar or foreign sounds which seem to come from the transmission may actually originate in some other part of the power train. A thorough check, by actual driving, should be made to determine the real source of the noise before any mechanical work is initiated on the transmission. Attention should be directed especially to the propeller shaft universal joints. Difficulties may be created, however, by reason of the following:

- (1) Improper or insufficient lubrication.
- (2) Stripped gears.
- (3) Worn bearings.
- (4) Worn gear teeth.
- (5) Worn clutch teeth.
- (6) Worn shaft splines.
- (7) Installation out of line.

TRANSMISSION

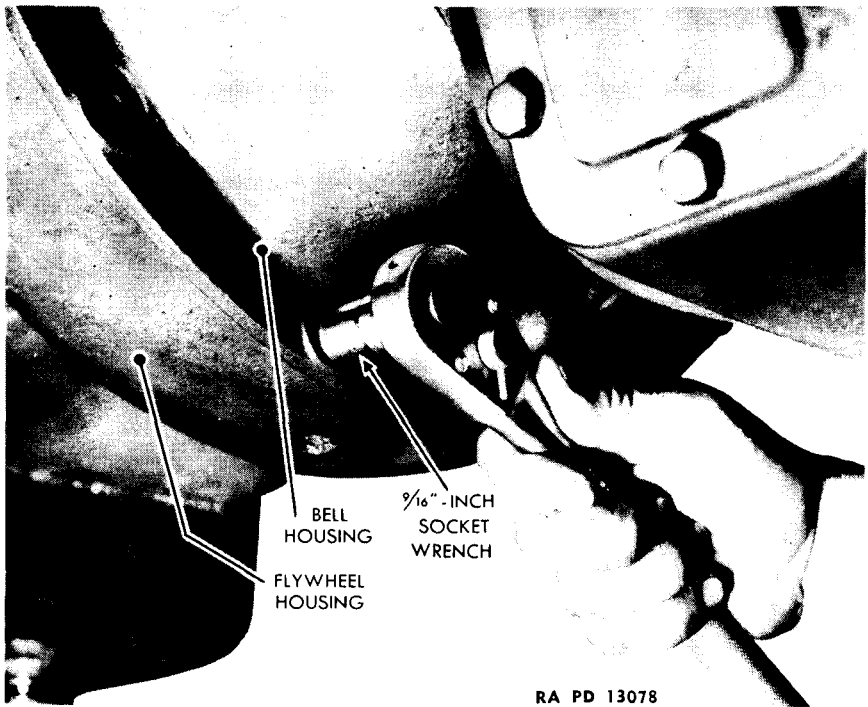

RA PD 13078

Figure 214 — Disconnecting Engine from Bell Housing

224. REMOVAL (figs. 214 and 215).

- | | |
|------------------------|-----------------------------|
| Block, chain, and hook | Screwdriver |
| Drift, brass | Wrench, box, 5/8-in. |
| Hammer | Wrench, open-end, 7/8-in. |
| Pail, large | Wrench, open-end, 1 1/8-in. |
| Pliers | Wrench, open-end, 5/8-in. |
| Rope, 1-in. | Wrench, socket, 1 1/8-in. |

a. Drain the Transmission.

- | | |
|------|---------------------------|
| Pail | Wrench, open-end, 5/8-in. |
|------|---------------------------|

Remove the drain plug (fig. 212) and allow the lubricant to drain into a large pail.

b. Remove the Floor Plate over the Transmission.

- Screwdriver.

Unscrew the transfer case shift lever ball and remove it. Remove six machine screws that hold the center floor plate, and remove the plate by lifting it over the transfer case shift lever.

c. Disconnect the Propeller Shaft.

- | | |
|----------------------|---------------------------|
| Wrench, box, 5/8 in. | Wrench, open-end, 5/8 in. |
|----------------------|---------------------------|

SCOUT CAR M3A1

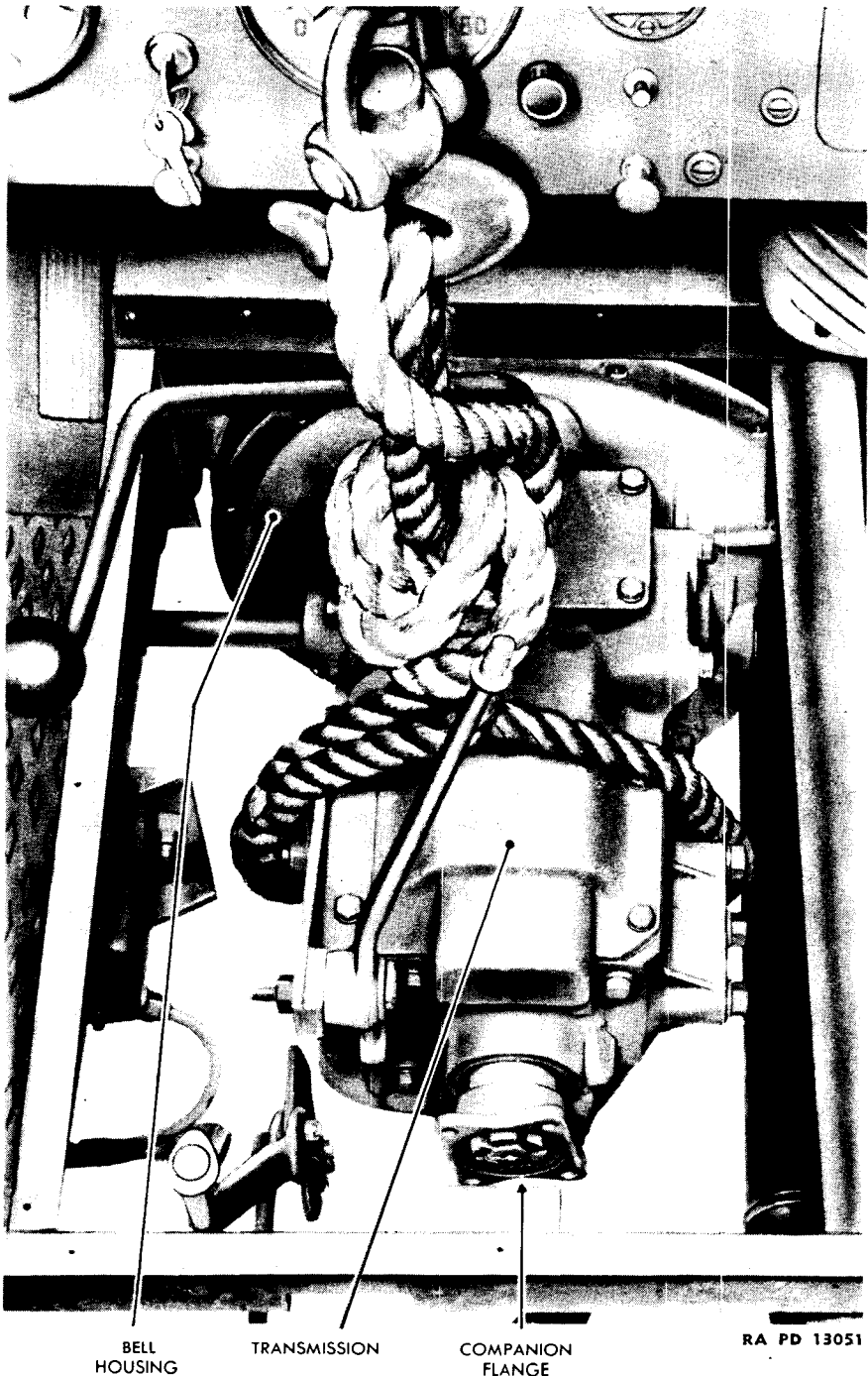

BELL
HOUSING

TRANSMISSION

COMPANION
FLANGE

RA PD 13051

Figure 215 — Removal of Transmission

TRANSMISSION

Remove four nuts, bolts and lock washers that hold the propeller shaft to the companion flange on the transmission (fig. 212).

d. Disconnect Clutch Release Shaft Lever.

Drift, brass
Hammer

Pliers

Remove cotter pin, and drive out rod end pin which holds clutch release shaft lever to the adjustable yoke.

e. Disconnect Clutch Release Shaft Support.

Wrench, open-end, $\frac{9}{16}$ -in.

Remove the two cap screws, plain washers and lock washers which hold the shaft support to the engine support bracket. Remove shaft support shims. The support will remain hanging on the clutch release shaft.

f. Disconnect Transfer Case Shift Lever from Shift Rod.

Drift, brass
Hammer

Pliers

Remove cotter pin, and drive out rod end pin that holds the shift lever to the yoke and rod.

g. Remove Hand Brake Lever.

Wrench, open-end, $\frac{9}{16}$ -in.

Remove two nuts which hold hand brake lever assembly to transmission.

h. Disconnect Throwout Bearing Outer Oil Tube (fig. 213).

Wrench, open-end, $\frac{7}{8}$ -in.

Remove inverted flared tube elbow on inner oil tube, to disconnect outer oil tube from inner tube.

i. Remove Master Cylinder Push Rod.

Drift, brass
Hammer

Pliers

Remove cotter pin, and drive out rod end pin that holds master cylinder push rod to master cylinder operating lever, and remove rod.

j. Mount Sling under Transmission.

Block, chain, and hook

Rope, 1-in.

Put rope around and under transmission, making certain that the assembly will be balanced in the sling during removal, in order to prevent injury to the splined shaft.

SCOUT CAR M3A1

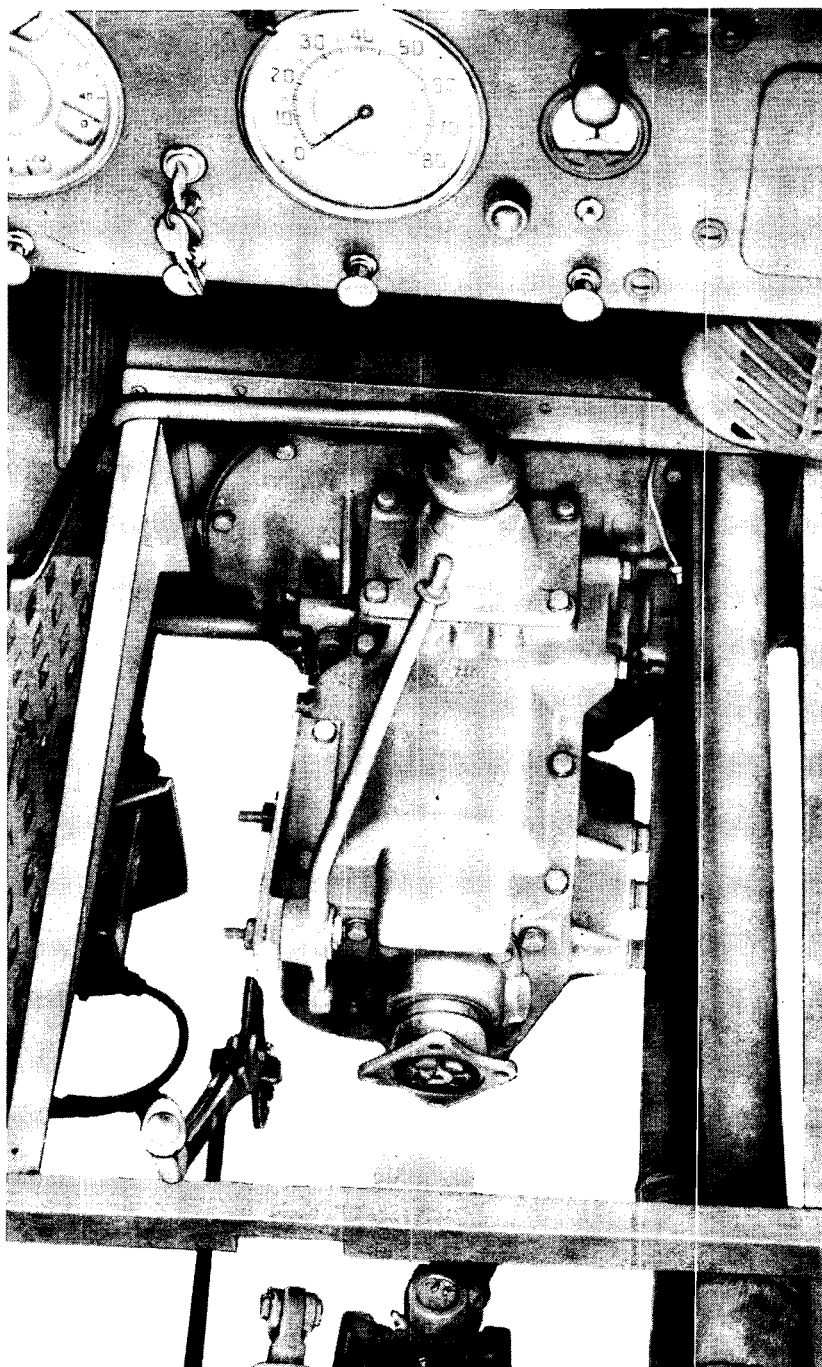

RA PD 13059

Figure 216 — Transmission Ready for Removal

TRANSMISSION

k. Disconnect Transmission Bell Housing from Flywheel Housing.

Wrench, socket, $\frac{9}{16}$ -in.

Remove the 12 cap screws and lock washers which hold bell housing to flywheel housing (fig. 214).

l. **Remove Transmission** (fig. 215). Using the sling as a support, push the transmission slowly toward the rear, rocking it slightly as it is withdrawn, until the splined shaft is free from the clutch. Be sure to keep the transmission in line, in order to prevent injury to the spline. Lower assembly to floor and slide out from under vehicle.

225. INSTALLATION.

Bar, pinch

Block, chain, and hook

Drift, brass

Hammer

Pliers

Rope, 1-in.

Screwdriver

Wrench, box, $\frac{5}{8}$ -in.

Wrench, open-end, $\frac{7}{16}$ -in.

Wrench, open-end, $\frac{9}{16}$ -in.

Wrench, open-end, $\frac{5}{8}$ -in.

Wrench, socket, $\frac{9}{16}$ -in.

a. Install Transmission.

Bar, pinch

Block, chain, and hook

Rope, 1-in.

Slide transmission under vehicle in approximately the correct position and put rope under and around assembly. Using a hoist, raise transmission into position and push assembly forward, engaging the spline in the clutch hub. Do not force spline into the hub. Be sure to keep the transmission in line, in order to prevent injury to the spline.

b. Connect Bell Housing to the Flywheel Housing (fig. 214).

Wrench, socket, $\frac{9}{16}$ -in.

Install 12 cap screws and lock washers that hold bell housing to flywheel housing.

c. Install Master Cylinder Push Rod.

Hammer

Pliers

Set push rod into master cylinder, and install rod end pin and cotter pin that hold master cylinder push rod to operating lever.

d. Connect Throwout Bearing Outer Oil Tube.

Wrench, open-end, $\frac{7}{16}$ -in.

Connect outer oil tube (fig. 213) to inner tube by screwing in inverted flared tube nut into elbow on inner oil tube.

SCOUT CAR M3A1

e. Install Hand Brake Lever.

Wrench, open-end, $\frac{9}{16}$ -in.

Install the two nuts that hold the hand brake lever to the transmission and connect the lever to the operating linkage of drive shaft brake (fig. 212).

f. Connect Transfer Case Shift Lever to Shift Rod.

Hammer

Pliers

Install rod end pin and cotter pin.

g. Connect Clutch Release Shaft Support.

Wrench, open-end, $\frac{9}{16}$ -in.

Install shims and two cap screws, plain washers and lock washers that hold shaft support to engine support bracket.

h. Connect Clutch Release Shaft Lever to Linkage.

Hammer

Pliers

Install rod end pin and cotter pin that hold release shaft lever to adjustable yoke.

i. Connect Rear Propeller Shaft.

Wrench, box, $\frac{5}{8}$ -in.

Wrench, open-end, $\frac{5}{8}$ -in.

Set shaft in place and install the four nuts, bolts and lock washers that hold the propeller shaft to the transmission companion flange.

j. Install Floor Board.

Screwdriver

Set floor plate down over transfer case shift lever and install six screws. Install transfer case shift lever ball.

k. Replace Lubricant. Fill transmission to proper level with LUBRICANT, gear, universal, seasonal grade.

Section XXXV

WHEELS

	Paragraph
Description	226
Trouble shooting	227
Maintenance and adjustments.....	228
Wheel bearings	229

226. DESCRIPTION.

a. The wheels are the demountable 20 x 7, steel-disk, spoke type. They have six mounting holes and are carried on opposed tapered roller bearings.

b. Two types of tires, both having mud and snow grip tread, are in use on these vehicles. The size is 8.25 x 20.

c. Inflation Pressures.

(1) Standard casings of 10-ply construction, weighing 95 pounds each, fitted with a bullet sealing tube, weighing 52 pounds each, were original equipment on the vehicles. Proper inflation pressures for this type of tire are 40 pounds per square inch for the front tires, and 65 pounds per square inch for the rear tires.

(2) Combat casings of 12-ply construction, weighing 145 pounds each, fitted with a standard heavy-duty tube, a flap, and a metal bead lock are now being used with a new divided rim wheel. Proper inflation pressures for the combat tire are 45 pounds per square inch for front tires, and 65 pounds per square inch for the rear tires.

227. TROUBLE SHOOTING.

a. Hard Steering.

Symptom and Probable Cause	Probable Remedy
Tires underinflated.	Inflate to correct pressure (par. 226 c).
Wheel bearings out of adjustment.	Adjust as specified in text.

b. Air Leakage.

Valve cap missing or cap seal broken.	Replace with new cap.
Valve core loose.	Retighten.
Valve core damaged.	Replace with new core.
Torn tube.	Repair by cold patching.

228. MAINTENANCE AND ADJUSTMENTS.

a. Tires and Tubes.

(1) Tires should be repaired in accordance with conventional meth-

SCOUT CAR M3A1

ods. Punctures and tears causing exposure of the cord or fabric should be vulcanized. Holes in bullet-resisting and puncture-sealing inner tubes should be repaired by cold patching. Hot patching or vulcanizing should not be attempted.

(2) Tires must be properly inflated and not operated when underinflated. Balanced tire pressures (if correct) facilitate steering, improve riding comfort, contribute to safer driving and maximum tire mileage. Before pumping air into tubes, depress valve momentarily to let old air blow out any dirt in the valve. Keep caps on valves to prevent entrance of foreign matter.

(3) Oil and grease have a harmful effect on rubber and every attempt should be made to keep these substances from coming in contact with tires or tubes.

b. Installation of Bullet Sealing Tube.

(1) The mounting instructions which follow apply to bullet-proof type tubes on drop-center rims with removable side flanges.

(2) The tube to be mounted should be deflated by using a vacuum line, or by removing its valve core and laying the tube on the floor under a weight sufficient to exhaust the air. The valve core should then be replaced and the weight removed. After the tube is inserted in the tire case, the valve core should again be removed and the tube inflated until it starts to spread the tire beads. The air chuck should then be removed and the air allowed to escape. The inflation operation should be repeated two or three times to insure proper seating of the tube inside the tire, with the valve core remaining out of the valve stem during the entire mounting procedure.

(3) The flange should be removed from the wheel and the latter laid flat on the floor or bench; the side without flange being turned up towards the operator. The assembled tire and tube should be examined and special note made as to the side on which the valve offset is located. The valve will be closer to one of the tire beads and will not be on center, the amount of off-center being about 1 inch.

(4) The tire should be laid on the rim with the offset side of the valve on top, or towards the operator, and the valve lined up with the rim valve hole. The first bead should be mounted with the same technique as employed for regular drop-center rims. Special effort should be made to keep the valve stem in line with the rim valve hole, so that after the first bead is applied the valve stem can be pulled through and the rim nut run down on the stem to hold it in place. The second bead should be mounted likewise.

(5) The rim flange should next be applied by forcing it down into

WHEELS

the rim well on one side, in the manner similar to that used when mounting a tire bead. In this connection, it should be noted that the removable flange has two cutaway places on the inside circumference. These places are 180 degrees apart and they must be in contact with the rim ledge when the flange is forced into the rim well. This point should be 90 degrees from each of the cutaway places.

(6) After the flange has been placed properly in the rim well, it should be sprung over the rim ledge on the opposite side by prying it lightly with a tire iron until it drops over this ledge. The rim flange should be centered on the wheel, the valve core inserted, and the tire inflated to 5 pounds over operating pressure. The tire should stand for a period of 2 hours to allow trapped air to escape, whereupon the air pressure should be adjusted for the desired operating range and the tire placed in service.

c. **Wheels.** Check and tighten wheel stud nuts daily for the first 500 to 1,000 miles of service to compensate "setting in" of clamping surfaces. Use wrench provided for the purpose, and do not use an extension on the handle or apply excessive force other than direct hand effort. Successively tighten opposite nuts to prevent cocking wheel on studs. Never use oil on wheel stud nuts.

229. WHEEL BEARINGS.

a. Adjustments.

Jack	Wrench, wheel bearing nut
Pliers	Wrench, wheel stud nut
Wrench, socket, with ratchet extension, $\frac{5}{8}$ -in.	

- (1) Jack up axle to free wheel concerned.
- (2) Remove eight hub cap nuts and cap.
- (3) Remove axle nut cotter pin, nut and drive flange.
- (4) With wheel bearing wrench, remove the bearing lock nut and ring.
- (5) Draw up the adjusting nut tightly against the outer bearing cone assembly. Revolve the wheel back and forth until the bearings bind and the wheel turns hard.

(6) Back off adjusting nut (about $\frac{1}{6}$ turn) until the wheel turns freely without perceptible end play. It may be necessary to tap the end of the axle sleeve while loosening the adjustment.

(7) Check end play by lifting with a pinch bar between the tire and floor, while a finger is placed between the bearing cone and cup.

SCOUT CAR M3A1

(8) Lock the assembly with the jam nut, making sure to prevent the adjusting nut from turning.

(9) Reassemble and test wheel movement again before releasing jack.

b. Wheel Bearing Removal.

Drift, brass

Wrench, socket, with ratchet extension, $\frac{5}{8}$ -in.

Hammer

Jack

Wrench, wheel bearing nut

Pliers

Wrench, wheel stud nut

Puller, bearing

(1) Jack up the axle to free the wheel concerned and remove the wheel with tire.

(2) Remove hub cap nuts and cap.

(3) Remove axle nut cotter pin, nut and drive flange.

(4) With wheel bearing wrench, remove the bearing lock nut and ring.

(5) Remove the bearing adjusting nut.

(6) Pull off brake drum assembly, carrying with it the outer bearing and cup, and the inner bearing cup.

(7) Pull off the inner bearing.

(8) Knock out bearing cups from brake drum with brass drift and hammer.

c. Wheel Bearing Installation.

Jack

Wrench, wheel bearing nut

Pliers

Wrench, wheel stud nut

Wrench, socket, with ratchet extension, $\frac{5}{8}$ -in.

(1) Lubricate with GREASE, general purpose, No. 2, and install, or replace with new bearings.

(2) Install brake drum assembly.

(3) Install bearing adjusting nut, bearing lock nut and ring.

(4) Install drive flange, axle nut and cotter pin. Install hub cap nuts and cap.

(5) Install the wheel and tire and remove the jack.

Section XXXVI

SHIPMENT AND STORAGE

	Paragraph
Shipment by rail.....	230
Shipment by water.....	231
Limited storage	232
Indefinite storage	233

230. SHIPMENT BY RAIL.

a. General Procedure. In case of shipment of individual vehicles or where the organization does not accompany its transportation, vehicles are turned over to the Quartermaster for shipment. In such a case, the Quartermaster is responsible for furnishing the necessary personnel and material for loading and blocking equipment. Vehicles are usually shipped on flat cars (36 to 50 ft. long), gondolas (36 to 60 ft. long), or special box cars (50 ft. long) designed for the handling of motor vehicles. Automobile cars or flat cars with wooden floors are the most desirable types because of the ease of loading and blocking.

b. Preparation of Railroad Cars. Transportation must be inspected to determine if the cars are in a suitable condition to carry the load safely to its destination. Strong floors are required. All loose nails, debris, and projections not an integral part of the car and the prescribed blocking must be removed.

c. Preparation of Vehicles for Loading. The vehicle should be completely lubricated in accordance with War Department Lubrication Guide No. 20. If troops are not traveling with their vehicles, all loose property and tools should be packed and secured in boxes, and hoods should be sealed down with car seals, and radiator shutters should be closed.

(1) When motor vehicles are shipped, fuel tanks, filters, fuel pumps and carburetors should be completely drained and the engine run to use up any remaining fuel. When vehicles are shipped with troops, draining of fuel is not required and unloading will be expedited.

(2) Tires should be inflated to at least 10 pounds above their normal pressure in order to avoid sagging or shifting of motor vehicles in blocks.

(3) Cooling system should be completely drained, and drain cocks on radiator, engine block and water pump cleared by inserting a wire, and left open. A large card reading "no water" will be firmly wired to the steering wheel, thereby indicating that the coolant has been drained.

(4) The positive battery cable should be disconnected, taped, and tied away from the battery. The ignition switch should be in the OFF position.

SCOUT CAR M3A1

COOLING SYSTEM	
Pet cocks on engine block open	_____
Pet cocks on radiator open	_____
Pet cocks on water pump open	_____
Pet cocks cleared 'insert wire'	_____
FUEL SYSTEM	
Fuel pump and carburetor drained	_____
Fuel tanks drained	_____
Engine run to use up fuel	_____
Filter drained	_____
STORAGE BATTERY	
Positive cable disconnected and taped	_____
Positive cable tied away from battery	_____
TIRES	
Inflated 10 pounds above normal	_____
MISCELLANEOUS	
Ignition switch off	_____
Gear shift levers in neutral	_____
Drive shaft brake set	_____
Hood closed and sealed	_____
Tops, curtains, and cushions secured	_____
Windshield and doors secured	_____
Keys in small cloth bag tied to steering wheel	_____
Vehicle tagged for destination	_____
Rust preventive measures complete	_____
Loose parts, and tools boxed and secured	_____
Parts missing	_____
Manuals missing	_____
Damages	_____

RA PD 3702

Figure 217 — Shipping Inspection

(5) Tops, curtains, and seat cushions should be secured against the weather. Windshield armor should be blocked to prevent possibility of crashing down on the windshield glass and windshield wipers. Doors should be closed and lashed.

(6) A systematic inspection should be made with the aid of a check sheet illustrated in figure 217.

(7) The key should be placed in a small cloth bag, securely wired to the steering wheel.

d. Facilities for Loading. Whenever possible, vehicles are loaded in and unloaded from open cars under their own power, utilizing permanent end ramps and platforms. Movement from one flat car to another, along the length of the train, is made possible by cross-over plates or a spanning platform, after dismounting car hand brake. An improvised ramp can be made from railroad ties. Vehicles may be loaded readily in gondola cars without drop ends by utilizing a crane. Secure slings through the pintle at the rear of the vehicle and the tow

SHIPMENT AND STORAGE

hooks at the front. In case of shipment in side-door box cars, a dolly-type jack should be used to warp the vehicle into position within the car. Removal may be possible under vehicle power, after power servicing.

e. **Securing.** In securing or blocking a vehicle, three motions (length-wise, sidewise and bouncing) must be prevented.

(1) Material for blocking on wooden-floored cars should be not less than 2 by 4 inches. Block cut from material 6 by 6, or 8 by 8 inches are preferable. Straps should be placed over the axles and secured to the floor. Canvas, cloth, or burlap should be placed between the blocks and rubber to reduce wear. Blocking should be snug to eliminate play. In case of metal floors, blocking between the side and end walk is required.

(2) The drive shaft brake should be set and the gears placed in neutral.

(3) Equipment moving from manufacturer to arsenal or proving ground, or from arsenal or proving ground to army post, or individual units moving from one army post to another must be placarded "DO NOT HUMP."

(4) Further details on loading are to be found in "Special Supplement Containing Rules Governing the Loading of Mechanized and Motorizing Army Equipment"; also, "Major Caliber Guns for the United States Army and Navy, on Open Top Equipment," published by the Association of American Railroads, Operations and Maintenance Department, April 1, 1941. Information on shipping instructions is also given in FM 101-10.

231. SHIPMENT BY WATER.

Preparation is, with certain modifications, the same as that indicated for rail shipment. However, the engine requires special attention to prevent internal corrosion.

a. Spark plugs must be removed and the interior of the cylinders sprayed thoroughly with OIL, lubricating, preservative, medium (preferably while the motor is warm). The spray must be directed to the valve parts and pistons while the engine is being cranked to get thorough internal surface coverage. This operation can also be carried out while the motor is running by spraying OIL, lubricating, preservative, medium into the carburetor air intake, with the motor at idling speed. The engine is speeded up, and when smoke starts to enter from the exhaust, the ignition is cut off and the spray is continued until the engine stops.

b. Fuel and cooling system will be completely drained, as indicated in shipment by rail.

SCOUT CAR M3A1

c. All apertures such as spark plug holes, crankcase breathers, front and rear axle breathers, bore housing air vent, exhaust pipe, etc., will be sealed. If carburetor is not removed, the air intake will be sealed. If carburetor is removed, the opening of the intake manifold will be sealed. Threaded metal plugs, corks, wooden plugs or tape may be used for this purpose.

d. The crankcase will be drained completely and a large tag reading "crankcase drained, refill with new oil before starting engine" must be firmly wired to the steering wheel.

e. Opening in generator and starter will be sealed with adhesive tape.

f. The clutch pedal must be blocked, with the clutch in the released position, in order to release pressure on clutch plate. Unless this is done serious difficulty may result due to corrosion.

g. All exposed, unpainted metal and working parts should be protected with a coat of COMPOUND, rust preventive, light or OIL, lubricating, preservative, medium.

h. Batteries will be removed and shipped dry, or packed in such a way that the unit must be handled in an upright position at all times. Leads should be taped and terminals coated with COMPOUND, rust preventive, light.

232. LIMITED STORAGE.

Vehicles in this category are those which are ready for immediate service but not used for less than thirty days. Fuel and oil will be retained to maximum capacity in the vehicles. Batteries will remain in their respective vehicles and be kept charged. The vehicles must be cleaned and lubricated thoroughly before they are placed in storage, and various types of nonmetallic material must be protected according to existing regulations. Brakes will not be set, and the transmission gear-shift will be placed in neutral.

233. INDEFINITE STORAGE.

Vehicles in this category are those which will not be required for service for an indefinite period. The storage of vehicles and equipment, and the inspection thereof for this situation is reviewed in AR 30-1055.

a. **Storage Conditions.** Vehicles will be stored in closed buildings or covered sheds, if available. In lieu thereof, cover with tarpaulins. Storage surface should be solid, free from crushed rock, deep dust and oil surfacing, and properly drained. Vehicles should be raised and blocked to keep the tires off the ground. If not completely serviced and maintained, each vehicle is tagged to indicate what repairs are required before it is returned to service.

SHIPMENT AND STORAGE

b. Drainage. Fuel tanks are drained and the openings plugged. The cooling system is drained also, and all drain cocks are opened and cleaned with a wire to insure removal of sediment that may block the flow of water. A light oil should be placed in the water pump.

c. Parts Removal. Engine mechanical accessories such as carburetors and fuel pumps, and electrical details such as distributors, lamps, generators, shielding, spark plugs, starting motors, etc., and small tools should be removed, wrapped in oiled paper to exclude moisture, and packed in a separate box for each vehicle. Each box must be marked to identify it with the proper vehicle but may be stored separately in warehouses, if practicable. Tires and batteries are removed and stored as indicated below.

d. Storage Batteries. Batteries removed from vehicles will be pooled with the general stock of issue batteries and kept charged and in service whenever possible.

e. Tires. Tires and tubes should be kept in a cool, dark, dry place. Used casings should be repaired, cleaned and wrapped in burlap, paper or cloth, and stored vertically side by side. Tubes should be deflated, removed from the casing, cleaned, repaired, folded loosely, and stored in pasteboard cartons. Care should be taken that there are no sharp folds and that a small amount of air should be left in the tube to keep creases from forming.

f. Rubber Parts. Rubber material such as engine mountings, grommets, etc., must be suitably protected to prolong the life and spring of the material by applying a so-called rubber lubricant recommended by the quartermaster.

g. Bodies. All exposed metal parts of the bodies and chassis (gun rails, etc.) should be slushed thoroughly. Oil drained from the crankcase, gear oil thinned with crankcase oil, or oil purchased for the purpose may serve as slushing oil.

h. Engines. The crankcase is drained and flushed with a light oil other than kerosene which causes corrosion. About $\frac{1}{2}$ pint of heavy mineral oil is poured into each cylinder and distributed by cranking the engine. Oil, grease, or graphite is placed in the threads of the spark plug holes. All openings are plugged with tapered, fitted wooden plugs. All exposed metal parts are given a coating of suitable slushing oil. A tag is placed on the engine on which inspectors enter initials and inspection dates.

SCOUT CAR M3A1

i. **Equipment.** Leather equipment will be preserved in accordance with instructions contained in AR 30-3040. Web equipment, felt washers, and other textiles will be sprinkled with NAPHTHALENE flake, as a moth preventive. The recommended concentration is obtained with about 1 pound of NAPHTHALENE per 100 cubic feet of material. Thick paper gaskets and paper gasket material will be kept impregnated with light oil to prevent shrinkage and drying. CARBON TETRACHLORIDE types of fire extinguishers must be kept filled with liquid to avoid decomposition and deformation of the cork seats and washers therein. Water is permissible in stored extinguishers, in lieu of regular extinguisher liquid, in emergency only. Flashlights must be stored without battery cells to avoid sulphation, which will otherwise occur with a resultant ruination of the flashlight housing and terminals. All other tools and accessories will be repainted or regreased if necessary.

j. **Inspection of Vehicles in Storage.** Inspection of vehicles in storage will be made not less than once each month, under the direct supervision of a commissioned officer, to see that instructions contained in AR 850-15 are being complied with.

Section XXXVIII

REFERENCES

	Paragraph
Standard nomenclature lists.....	234
Explanatory publications	235

234. STANDARD NOMENCLATURE LISTS.

a. Armament.

Gun, machine, cal. .30, Browning, M1917 and M1917A1, and mounts	SNL A-5
Gun, machine, cal. .50, Browning, M2, heavy barrel fixed and ground mounts	SNL A-39
Gun, submachine, cal. .45, Thompson, M1928A1 and M1	SNL A-32

b. Scout cars, M3A1..... SNL G-67

c. Cleaning, preserving, and lubricating materiels, recoil fluids, special oils, and similar items of issue.... SNL K-1

Current Standard Nomenclature Lists are as tabulated here. An up-to-date list of SNL's is maintained as the "Ordnance Publications for Supply Index".... OPSI

235. EXPLANATORY PUBLICATIONS.

a. Armament.

Browning machine gun, cal. .50, M1917.....	FM 23-55
Browning machine gun, cal. .50, HB, M2, ground....	FM 23-60
Browning machine gun, cal. .50, HB, M2 (mounted in combat vehicles)	FM 23-65
Grenades	FM 23-30
Thomson submachine gun cal. .45, M1928A1	FM 23-40

b. Automotive Materiel.

Automotive brakes	TM 10-565
Automotive power transmission unit.....	TM 10-585
Chassis, body, and trailer unit.....	TM 10-560
Ordnance maintenance: power train for scout cars—now being published as TM 9-1705.....	TM 9-1705A
Ordnance maintenance: Hercules JXD gas engine for scout cars—now being published as TM 9-1706.....	TM 9-1705B
Ordnance maintenance: Hercules DJXD Diesel engine for scout cars.....	TM 9-1705C
Ordnance maintenance: Buda 6DT 317 engine for scout cars	TM 9-1705D
Ordnance maintenance: body and chassis for scout cars—now being published as TM 9-1709.....	TM 9-1705E

SCOUT CAR M3A1

- c. Cleaning, preserving, lubricating, and welding materials and similar items issued by the Ordnance Dep't **TM 9-850**
- d. Maintenance and Inspection.**
- | | |
|---|----------------------|
| Automotive lubrication | TM 10-540 |
| Detailed lubrication instructions for ordnance materiel | OFSB 6 series |
| Echelon system of maintenance..... | TM 10-525 |
| Fire prevention, safety precautions, accidents..... | TM 10-360 |
| Hand, measuring, and power tools..... | TM 10-590 |
| Maintenance and repair..... | TM 10-520 |
| Motor transport inspection..... | TM 10-545 |
| Tune up and adjustment | TM 10-530 |
- e. Miscellaneous.**
- | | |
|--|------------------|
| Automotive electricity | TM 10-580 |
| Camouflage | FM 5-20 |
| Defense against chemical attack..... | FM 21-40 |
| Explosives and demolitions | FM 5-25 |
| Fuels and carburetion..... | TM 10-550 |
| List of publications for training, including training films and film strip | FM 21-6 |
| Military motor transportation..... | TM 10-505 |
| Military motor vehicles..... | AR 850-15 |
| The internal combustion engine..... | TM 10-570 |
- f. Storage of Motor Vehicle Equipment.....** **AR 850-18**

INDEX

A	Page No.	Page No.
Absorbers (See Shock absorber(s) (connecting links))		
Accessories		
carried in and out of vehicle.....	46	
description, general	56	
(See also Electrical system and accessories and Fuel system and accessories)		
Adjustments of: (See also Maintenance (and adjustments))		
axle, rear	66-68	
fan belts (cooling system)		
Buda-Lanova Diesel engine	126-127	
gasoline engine	108	
Hercules Diesel engine	121	
governor (Hercules Diesel engine)	216	
ignition timing (gasoline engine)	167-168	
service brake	90-92	
pedal linkage	90-91	
shock absorbers	337	
steering knuckle bearing	59-60	
toe-in of wheels	60-61	
vacuum pump belt	241	
valve tappet (Hercules gasoline engine)	203-204	
wheel bearings	361-362	
Air cleaner		
Diesel engine	88	
gasoline engine powered vehicles		
description	300	
installation	302	
maintenance	300-301	
removal	301-302	
vacuum power booster	86	
Air leakage in tire.....	359	
Ammeter		
description	329-330	
gasoline engine powered vehicles		
trouble shooting	169-170	
Ammunition, cleaning gas exposed....	49	
Antifreeze chart for cooling systems	116	
Armament		
accessories	46	
carriage	22-26	
cradle mount	26	
tripod mount M1917A1.....	22	
tripod mount M3	22	
weapons and mounts	22	
Automotive materiel, special precau- tions for	51	
Axle (assembly)		
front		
description of	57	
installation of	64-65	
maintenance and adjustment operations	52, 59-61	
removal of	62-64	
trouble shooting	57	
rear		
description of	66	
installation of	71-72	
maintenance service and adjust- ments	66-68	
removal of	69-71	
trouble shooting	66	
B		
Batteries(-y)		
Diesel engine	175-177	
gasoline engine	129-135	
battery fluid	132	
installation	135	
maintenance	132	
removal	133	
temperature effects	132-133	
voltmeter check	129-132	
Hercules gasoline engine		
checking in tune up	193	
lubrication and servicing instruc- tions	41	
storage	367	
Bearings (See specific names)		
Blackout lamp, Diesel and gasoline engine powered vehicles.....	172	
Bleeding brake lines	92-94	
Blocking or securing vehicle.....	365	
Body of vehicle		
description of	8-10, 73	
fenders		
description	73-75	
installation	76	
removal	75-76	
maintenance operations	53	
replacement and maintenance of.....	73	
slushing of for storage.....	367	

SCOUT CAR M3A1

INDEX

B—Cont'd	Page No.	Page No.
Body of vehicle — Cont'd		
windshield wipers		
description	77	
installation	77-78	
removal	77	
trouble shooting	77	
Bosch fuel injection system		
Buda-Lanova Diesel engine....	323-328	
check valve	327	
description	323	
fuel filters	328	
fuel ignition timing.....	324-326	
fuel injection pump	323-324	
fuel nozzle and holder as-		
sembly	327-328	
fuel transfer pump	317-318	
governor	326-327	
Hercules Diesel engine.....	306-322	
check valve	316	
description	306	
fuel filter	320-322	
fuel injection pump	306-315	
fuel nozzle and holder as-		
sembly	318-320	
fuel transfer pump	317-318	
governor	315-316	
Brake fluid reservoir	40-41	
Brake hoses (axle, front)		
connect at frame	64-65	
disconnect at frame	63	
Brake lines, bleeding	92-94	
Brake systems	79-98	
bleeding the lines	92-94	
description, general	79	
drive shaft brake		
adjustment	94-95	
description	94	
installation	97-98	
removal	95-97	
replacement	97	
maintenance operations	53	
master cylinder		
description	83	
installation	83-84	
removal	83	
servicing	83	
service brake adjustments		
after relining	92	
brake lines	92	
lining wear	91-92	
pedal linkage	90-91	
service brake pedal linkage.....	89-90	
service brake shoes		
description	88	
installation	89	
removal	88-89	
trouble shooting	79-83	
vacuum power booster		
air cleaner	86	
check valve	87-88	
description	84	
installation	85-86	
removal	85	
testing	84-85	
vacuum pump air cleaner (Diesel		
engine only)	88	
Brake vacuum cylinder.....	40	
Braking operation	19	
Breaker contacts (gasoline engine		
powered vehicles)	155-157	
Buda-Lanova Diesel engine:		
Bosch fuel injection system....	323-328	
(See under above name for de-		
tailed information)		
characteristics	267	
cleaning carbon	240	
cooling system	126-128	
(See under above name for de-		
tailed information)		
cylinder head		
installation	274-278	
removal	268-274	
description	267	
electrical system and acces-		
sories	175-189	
(See under above name for de-		
tailed information)		
flywheel marking	279	
lubrication instructions for.....	35-38	
manifold		
installation	281-282	
removal	279-281	

SCOUT CAR M3A1

INDEX

C—Cont'd	Page No.	Page No.
Color, paint as camouflage.....	44	
Controls		
description	10-11	
trouble shooting (gasoline engine powered vehicles)	305	
Cooling system		
Buda-Lanova Diesel engine....	126-128	
cautions	115-116	
description of	126	
fan	126-127	
radiator	104-107	
servicing	116-117	
thermostat	127-128	
trouble shooting	104	
water pump	127	
gasoline engine	103-117	
cautions	115-116	
description of	103	
fan	108-111	
radiator	104-107	
servicing	116-117	
trouble shooting	104	
water pump	111-115	
Hercules Diesel engine	118-125	
cautions	115-116	
description of	118	
fan	119-122	
radiator	104-107	
servicing	116-117	
thermostat	124-125	
trouble shooting	104	
water pump	122-124	
maintenance operations	53	
Corrosion, prevention of in water shipment	365-366	
Cradle mount M30 (Browning ma- chine gun, cal. .50, M2).....	26	
Crankcase, capacity of	6	
Crew	3	
Current regulator relay (Diesel and gasoline engine powered vehicles)	144	
Cut-out relay (Diesel and gaso- line engine powered vehicles)..	143-144	
Cylinder head		
Buda-Lanova Diesel engine		
installation	274-278	
removal	268-274	
Hercules Diesel engine		
installation	227-234	
removal	223-227	
Hercules gasoline engine		
installation	195-196	
removal	193-195	
Cylinders, missing (Buda-Lanova, Hercules and Diesel engines).....	221	
D		
Data, tabulated (vehicle)	3-6	
Decontamination		
procedure for	50-51	
protective measures	49-50	
Definitions of maintenance terms.....	52	
Description		
air cleaner (gasoline engine).....	300	
axles		
front	57	
rear	66	
body of vehicle	73	
fenders	77	
windshield wipers	77	
Bosch fuel injection system		
Buda-Lanova Diesel engine	323	
Hercules Diesel engine	306	
brake systems		
bleeding the lines	92-94	
description, general	79	
drive shaft brake	94	
master cylinder	83	
service brake shoes	88	
vacuum power booster	84	
Buda-Lanova Diesel engine	267	
carburetor (gasoline engine)	298	
carriage for machine gun mounts	24-25	
clutch	99	
controls	10-11	

INDEX

D—Cont'd	Page No.		Page No.
Description — Cont'd		Dismounting gun and cradle mount	
cooling systems		M30	26
Buda-Lanova Diesel engine.....	126	Distributor cover and rotor (gasoline engine)	168-169
gasoline engine	103	Distributor (electrical system)	
Hercules Diesel engine	118	gasoline engine	
electrical system and accessories		description	154-155
Diesel engine	175	installation	158-160
gasoline engine	129	latest models	
exhaust system	293	installation	160-17
fuel system and accessories (gasoline engine powered vehicles)....	295	removal	16
gasoline engine powered vehicles....	108	lubrication	15
Hercules Diesel engine	217	maintenance and adjustment	155-157
Hercules gasoline engine	190	removal	157-158
instrument cluster	329	Hercules gasoline engine checking	
mounts, tripod, M1917A1 and M3	22	in tune up	193
oil pump		Drag link	
Hercules Diesel engine	235-236	axle, front	
Hercules gasoline engine	198	connect	64
propeller shafts	333	disconnect	63
shock absorbers	336	steering gear	339
speedometer	331	Draining	
springs	335	fuel tanks for storage	367
steering gear	339	oil (engine lubricating system).....	40
transfer case	347	Drive gear, Bosch fuel injection system (Hercules Diesel engine).....	306
transmission	351	Drive shaft brake (<i>See under Brake systems</i>)	
vacuum pump (Hercules Diesel engine)	240		
valve mechanism (Hercules Diesel engine)	237		
valves (Hercules gasoline engine)..	198		
vehicle	8-10		
voltmeter	332		
wheels	359		
Diesel engine			
cold weather operation	21		
starting and warming up of			
precautions	14-15		
after long shut-down	15-16		
routine method	17		
(<i>See also Buda-Lanova and Hercules Diesel engines</i>)			
Dimensions of vehicle	3		

E

Electrical system and accessories	
Diesel engine powered vehicles	
batteries	175-177
description	175
fuzes	170-171
generator	180-187
head lamps	171-172
heater	173-174
horn	174
series-parallel switch	187-188
shielding	188
starting motor	178-180
switches	188-189
tail lamps	172-173
trouble shooting	136, 138-139

SCOUT CAR M3A1

INDEX

E—Cont'd	Page No.	Page No.	
Electrical system and accessories—Cont'd			
gasoline engine powered			
vehicles	129-174	fan, hub, and bracket assembly	
battery	129-135	installation	109
description	129	removal	108
distributor	154-161	lubrication	111
fuses	170-171	Hercules Diesel engine	
generator	137-143	fan belts	
head lamps	171-172	adjusting	121
heater	173-174	replacing	121-122
horn	174	fan blade, removal and installa-	
ignition coil	149-154	tion	119
ignition trouble shooting	168-170	fan pulley and bracket, removal	
shielding	165-166	and installation	120
spark plugs	161-165	function of	119
starting motor	135-137	Fenders	
switches	171	description	73-75
tail lamps	172-173	installation	76
terminal box	171	removal	75-76
timing	167-168	Filter, voltage regulator	
maintenance operations	53	Diesel and gasoline engine	
Engine lubricating system		powered vehicles	148-149
oil filter	39	(See also Fuel filters)	
oil level	40	Fluid, battery (gasoline engine).....	132
servicing	40	Flywheel marking	
Engines (See also specific names)		Buda-Lanova Diesel engine	279
maintenance operations	53	Hercules Diesel engine	235
parts removal for storage of vehicle	367	Frame of vehicle	294
preparation of for storage.....	367	Front end of vehicle (axle, front)	
types used in Scout car M3A1.....	10	lower	65
		raise	62
F		Fuel filters	
Fan (cooling system)		Bosch fuel injection system	
Buda-Lanova Diesel engine	126-127	Buda-Lanova Diesel engine	328
adjusting fan belts	126-127	Hercules Diesel engine	
description	126	cleaning	320-322
removal and installation	127	description	320
removal of fan and pulley.....	126	installation and removal	322
gasoline engine		Fuel gage	
adjusting fan belt	108	description	330
description	108	gasoline engine powered vehicles..	171
fan blades			
installation	111		
removal	109-111		

INDEX

F—Cont'd	Page No.		Page No.
Fuel injection pump		carburetor	
Bosch fuel injection system		description	298
Buda-Lanova Diesel engine		installation	300
description and operation	306-307	maintenance and adjustment..	298
installation	323-324	removal	299
removal	323	description	295
Hercules Diesel engine		filter	297
drive gear	306	fuel and vacuum pump	
installation	309-315	description	295
lubrication	315	installation	296
operation	307	maintenance	295-296
removal	307-308	removal	296
trouble shooting	304-305	fuel tanks	295
Fuel injection system (See Bosch fuel injection system)		trouble shooting	302-305
Fuel injection timing		carburetor	304
Bosch fuel injection system		controls	305
Buda-Lanova Diesel engine		fuel	302-303
explanation of	324	fuel pump	304-305
procedure for	324-326	manifolds	305
Fuel knocks in cylinders	222	Fuel tanks	
Fuel nozzle and holder assembly		drainage of for storage of vehicle....	367
Bosch fuel injection system		gasoline engine powered vehicles....	295
Buda-Lanova Diesel engine		Fuel transfer pump	
description	327	Bosch fuel-injection system	
removal and installation.....	328	Hercules and Buda-Lanova Diesel engines	
Hercules Diesel engine		description	317
description	318	installation	318
installation	319-320	priming device	317
removal	319	removal	317-318
Fuel pump (See under Fuel system and accessories)		Fuel trouble (gasoline engine)....	302-303
Fuel system		Fuses (Diesel and gasoline engine powered vehicles).....	170-171
lubrication and servicing instructions	41		
maintenance operations	54		
Fuel system and accessories			
gasoline engine powered vehicles			
air cleaner			
description	300		
installation	302		
maintenance	300-301		
removal	301-302		

G

Gages (See Instruments and gages)	
Gas, materiel affected by	49-51
automotive materiel, special precautions for	51
cleaning	49
decontamination	49-51
procedure for	50-51
protective measures	49-50
protective measures	49

SCOUT CAR M3A1

INDEX

G—Cont'd	Page No.	Page No.	
Gasoline engine powered vehicles		Heater	
cold weather operation	20-21	Diesel engine	
cooling system	103-117	function	173
electrical system and accessories	129-174	removal and installation.....	174
fuel system and accessories.....	295-305	gasoline engine	
(See under above names for detailed information)		function of	173
starting and warming up.....	11-14	installation and removal.....	174
stopping	21	type and removal of	171
(See also Hercules gasoline engine)		Hercules Diesel engine	217-266
Gearshifts		Bosch fuel injection system....	306-322
caution	19	(See under above name for detailed information)	
operation	17-19	characteristics	217
transfer case	18	cleaning carbon	240
transmission	18	cooling system	118-128
Generator		(See under above name for detailed information)	
Diesel engine		cylinder head	
description	180	installation	227-234
installation	185-187	removal	223-227
maintenance and adjustment.....	138	description, general	217
removal	181-185	electrical system and accessories	175-189
trouble shooting	138-139	(See under above name for detailed information)	
gasoline engine		engine vacuum pump oil separating tank	245-246
description	137-138	flywheel marking	234
installation	141-143	installation of	258-266
maintenance and adjustment.....	138	manifold, removal and installation of	234
removal	140-141	oil filter	246
trouble shooting	138-139	oil pan	234-235
Governor		oil pump	235-237
Bosch fuel injection system		removal of	246-257
Buda-Lanova Diesel engine	326-327	trouble shooting	219-222
Hercules Diesel engine		vacuum pump	240-245
adjustment	316	valve mechanism	237-240
description	315	Hercules gasoline engine	
lubrication	316	characteristics	191
Grinding valves (Hercules gasoline engine)	201	cleaning carbon	204

H

Halt, inspection at the.....	28-29
Hand brake, location and use of.....	11
Head lamps (Diesel and gasoline engine powered vehicles)	171-172

INDEX

H—Cont'd	Page No.	Page No.
Hercules gasoline engine — Cont'd		
cylinder head		type 171
installation 195-196		Inflation pressures of tires..... 359
removal 193-195		Inspection
description, general 190		at the halt 28-29
flywheel marking 196		charts, preventive maintenance.. 32-34
installation of 212-216		operation
manifold, removal and installation		after 29
of 197		during 28
oil pan, removal and installa-		periodic
tion of 197-198		additional inspection list for
oil pump 198		Diesel engines 31
removal of 204-212		1,000 miles 29-31
trouble shooting 191-193		prestating 28
tune up 193		purpose 27-28
valves 198		vehicles in storage 368
removal and installation of.. 199-204		Instrument cluster
Hood of engine, description of..... 8		ammeter 329-330
Horn (button)		description of 329
Diesel engine powered vehicles..... 175		fuel gage 330
gasoline engine powered vehicles.. 174		oil pressure gage 330
removal and installation 344		removal of 330-331
Hydraulic brake hose (axle, rear)		Instruments and gages 329-332
connect 72		instrument cluster 329-331
disconnect 71		maintenance operations 54
Hydrometer correction chart 133		speedometer 331
		voltmeter 332
I		
Ignition (gasoline engine)		K
coil		Kits, list of items in..... 48
description 149-150		
installation 152-154		L
removal 150-152		Leakage in cooling systems..... 104
trouble shooting and mainte-		Lights (gasoline engine powered ve-
nance 150		hicles) 171
timing, adjustment of 167-168		Liquid chemicals, removal of..... 49-51
trouble shooting		Loading
ammeter		facilities for 364-365
abnormal discharge 170		preparation of vehicles for..... 363-364
no discharge 170		"Log Book," use of..... 48
normal discharge 169-170		Lubricating system (See Engine lub-
coil distributor circuit and cover 168		ricating system)
distributor rotor 168-169		Lubricating devices, painting 45
spark plugs		
cables 169		
testing 169		

SCOUT CAR M3A1

INDEX

L—Cont'd	Page No.	Page No.
Lubricating oil filter (See Oil filter)		generator 138
Lubrication (system)		head lamps 172
carriage for machine gun mounts.. 26		ignition coil 150
cooling system		shielding 165
gasoline engine		starting motor 136
fan hub roller bearings..... 111		springs 337
water pump 112		steering gear 342-344
Hercules Diesel engine		tires and tubes 359-360
fan 121		Maintenance of:
water pump 124		body of vehicle 73
cradle mount M30 26		Bosch fuel injection system
detailed instructions 40-41		Buda-Lanova Diesel engine
battery 41		check valve 327
brake fluid reservoir..... 40-41		secondary fuel filters 328
brake vacuum cylinder 40		Hercules Diesel engine
fuel system 41		check valve 306
reports and records 41		exhaust system 293
shock absorbers 40		gasoline engine powered vehicles
distributor (gasoline engine)..... 157		air cleaner 300-301
engine lubricating system 39-40		fuel pump 295-296
general remarks on..... 35		vacuum pump 295-296
governor (Hercules Diesel engine) 46		propeller shafts 333
instructions for engines		Maintenance operations 52-55
Buda-Lanova Diesel 35-38		definition of terms 52
Hercules Diesel 38-39		repair jobs, allocation of 52-54
maintenance operations 54		scope of 52
methods of application 39		trouble shooting, general 55
schedules 35		Maintenance, preventive, charts
		1,000 miles 32-33
		prestarting, during operation and
		after operation 34
		Manifold
		Buda-Lanova Diesel engine
		installation 281-282
		removal 279-281
		gasoline engine
		trouble shooting 305
		Hercules Diesel engine
		removal and installation..... 234
		Hercules gasoline engine 197
		Manuals, manufacturers', use of 48
		Marking flywheel (See Flywheel
		marking)

M

Maintenance (and adjustments)

axle, front 59-61	
steering knuckle bearing 59-60	
axle, rear 66-68	
clutch 100-101	
electrical system	
Diesel engine powered vehicles	
generator 138	
head lamps 172	
shielding 166	
starting motor 136	
gasoline engine powered vehicles	
battery 132	
carburetor 298	
distributor 155-157	

INDEX

M—Cont'd	Page No.	Page No.
Master cylinder (See under Brake systems)		
Matériel affected by gas (See Gas, matériel affected by)		
Metal parts (surfaces)		
care of gas exposed	49	
painting	43-44	
slushing for storage	367	
Mounts, tripod, M1917A1 and M3....	22	
N		
Noises in:		
transfer case	348	
transmission	352	
Number of crew	3	
O		
Oil		
engine lubricating system	40	
Hercules gasoline engine	192	
Oil filter		
description and location of.....	39	
Hercules Diesel engine	246	
Oil pan		
Buda-Lanova Diesel engine	282	
Hercules Diesel engine		
installation	235	
removal	234-235	
Hercules gasoline engine		
installation	198	
removal	197-198	
Oil pressure gage	330	
Oil pump		
Buda-Lanova Diesel engine	282-283	
Hercules Diesel engine		
description	235-236	
installation	236-237	
Hercules gasoline engine	198	
Oil separating tank (See Hercules Diesel engine under Vacuum pump)		
Operation		
brakes	19	
clutch	99	
cold weather		
Diesel engine powered vehicles..	21	
gasoline engine powered vehicles	20-21	
fuel injection pump (Hercules Diesel engine)	307	
gearshifts	17-19	
cautions	19	
transfer case	19	
transmission	18	
inspection		
after	29	
during	28	
traction aids	19-20	
vehicle		
starting on a grade.....	17	
starting on level ground.....	17	
voltage regulator (Diesel engine powered vehicles)	148	
Ordinance Motor Book, use of.....	48	
Organization spare parts	56	
Overheating cooling systems	104	
P		
Paint(-ing)		
(as) camouflage		
color, gloss, and stenciling.....	44	
preserving	44-45	
lubricating devices	45	
metal surfaces	43-44	
preparing for	43	
removing	45	
Panel lights (gasoline engine powered vehicles)	171	
Periodic inspection		
additional list for Diesel engines....	31	
1,000 miles	29-31	
Pintle and toe hooks.....	294	
Popping, spitting, and knock in engines	193	
Precautions (special)		
automotive matériel	51	
shielding (Diesel and gasoline engines)	165-166	

SCOUT CAR M3A1

INDEX

P—Cont'd	Page No.	Page No.
Precautions (special) — Cont'd		
starting and warming up (Diesel engine)	14-15	steering gear
Preservation (See Care and preservation)		344-346
Prestarting inspection.....	28	vacuum pump belt
chart	34'	241
Priming device (Buda-Lanova and Hercules Diesel engines)	317	Replacing, definition of.....
Propeller shafts		52
axles		Roller of frame
front		294
connect	64	Rubber parts, storage of.....
disconnect	62-63	367
rear		
connect	72	S
disconnect	71	Schedules, lubrication
description and maintenance	333	35
unit replacement	333-334	Scout Car M3A1 (See Vehicle)
Pumps (See <i>specific names</i>)		Seating accommodations
		10
		Securing or blocking vehicle.....
		365
		Secondary fuel filter (Buda-Lanova Diesel engine)
		328
		Series-parallel switch (Diesel engine powered vehicles)
		187-188
		Service brake pedal linkage.....
		88-90
		adjustments
		90-91
		Service brake shoes and adjustments (See <i>under Brake systems</i>)
		Service head lamp.....
		172
		Servicing
		cooling systems
		Buda-Lanova Diesel engine..
		116-117
		gasoline engine
		116-117
		water pump
		111-112
		Hercules Diesel engine.....
		116-117
		water pump
		123
		definition of
		52
		engine lubricating system.....
		40
		master cylinder
		83
		spark plugs (gasoline engine).....
		164
		Shielding (electrical system)
		Diesel engine powered vehicles
		description
		188
		maintenance
		166
		precautions
		165-166
		gasoline engine powered vehicles
		description
		165
		maintenance
		166
		precautions
		165-166
		testing
		166

INDEX

S—Cont'd	Page No.	Page No.	
Shift levers	11	Spring clips	
Shifting (See Gearshifts)		axles	
Shimmy		front	
axle, front	57	disconnect	63
steering system	339	install	64
Shipment and storage	363-368	rear	
shipment by rail	363-365	connect	72
shipment by water	365-366	remove	70
storage		Springs	
indefinite	366-368	axle, rear	
limited	366	connect	72
Shock absorber(s) (connecting links)		disconnect	70-71
adjustments	337	description	335
axles		maintenance and adjustments....	54, 337
front		removal and installation	337-338
connect	64	trouble shooting	336
disconnect	63	Starter (gasoline engine).....	171
rear		Starting and warming up	
connect	72	Diesel engine	
disconnect	70	after long shut-down.....	15-16
description	336	precautions	14-15
lubrication and service instructions	40	routine method	17
maintenance operations	54	gasoline engine	11-14
removal and installation	338	Starting, hard (Buda-Lanova and Hercules Diesel engines).....	219
Slipping clutch	99	Starting hints	14
Slushing metal parts for storage.....	367	Starting motor	
Smoke in exhaust gases (Buda-Lanova and Hercules Diesel engines)	221-222	Diesel engine powered vehicles	
Spark plugs		description	178
gasoline engine powered vehicles		installation	179-180
description	161-164	maintenance and adjustments....	136
installation	165	removal	179
removal	165	trouble shooting	178-179
replacement	164-165	gasoline engine powered vehicles	
servicing	164	description	135-136
trouble shooting	169	installation	137
Hercules gasoline engine		maintenance and adjustments....	136
checking in tune up.....	193	removal	137
Speed, data on.....	6	trouble shooting	136
Speedometer assembly	331	Starting the vehicle.....	17
		Steering, hard	
		axle, front	57
		trouble shooting	342
		wheels	359

SCOUT CAR M3A1

INDEX

S—Cont'd	Page No.		Page No.
Steering gear		Throttle, location and use of.....	11
description	339	Timing, ignition, adjustment of..	167-168
maintenance and adjust- ments	54, 342-344	Tires and tubes	
replacement of components.....	344-346	inflation pressure	359
trouble shooting	339-342	maintenance and adjustments..	359-369
Steering knuckle bearing, adjust- ment of	59-60	storage of	367
Steering wheel	10	(See also Wheel and tire assem- bly)	
Stopping		Toe hooks	294
gasoline engine	21	Toe-in adjustment of front wheels..	60-61
vehicle	19	Tools and equipment.....	46-48
Storage		equipment	46
batteries	367	general remarks on.....	46
care of	133	manuals	48
(See also Shipment and storage)		Ordnance Motor Book.....	48
Switches		tools	46-48
Diesel engine powered		Top of vehicle body.....	10
vehicles	171, 188-189	Traction aids	19-20
gasoline engine powered vehicles....	171	Transfer case	
		description	347
T		installation	349-350
Tail lamps (Diesel and gasoline engine powered vehicles).....	172-173	removal	349
Temperature effects on battery..	132-133	trouble shooting	347-348
Terminal box (Diesel and gasoline engine powered vehicles)	171	use of in shifting.....	18
Terms, maintenance, definition of....	52	Transfer pump (See Fuel transfer pump)	
Testing		Transmission	
gasoline engine powered vehicles		description	351
shielding	166	installation	357-358
spark plugs	169	maintenance operations	54
vacuum power booster	84-85	removal	353-357
Thermostat (cooling system)		trouble shooting	351-353
Buda-Lanova Diesel engine		use of in shifting.....	18
description	127	Tripod mounts, M1917A1 and M3....	22
installation	128	Trouble shooting	
removal	127-128	axles	
Hercules Diesel engine		front	57
description	124	rear	66
installation	125	brake systems	79-83
removal	124	Buda-Lanova Diesel engine.....	219-222

INDEX

T—Cont'd	Page No.	Page No.
Trouble shooting — Cont'd		
clutch	99-100	
cooling systems	104	
electrical system		
Diesel engine	136, 138-139	
generator	138-139	
starting motor	178-179	
gasoline engine		
ammeter	169-170	
generator	138-139	
ignition coil	150	
spark plug	169	
starting motor	136	
Hercules Diesel engine	219-222	
Hercules gasoline engine	191-193	
ignition (<i>See under Ignition</i>)		
references to within text	55	
springs	336	
steering gear	339-342	
transfer case	347-348	
transmission	351-352	
wheels	359	
windshield wipers	77	
Tune up of Hercules gasoline engine ..	193	
V		
Vacuum power booster (<i>See under Brake systems</i>)		
Vacuum pump		
gasoline engine		
description	295	
maintenance	295-296	
removal and installation	296	
Hercules Diesel engine		
belt, adjustment and replacement of	241	
description	240	
installation	242-245	
oil separating tank		
installation	246	
removal	245	
removal of	242	
Valve(s) (mechanism)		
Buda-Lanova Diesel engine ..	278-279	
Hercules Diesel engine		
description	237	
installation	238-240	
removal	237-238	
Hercules gasoline engine		
description	198	
grinding	201	
installation	201-203	
removal	199-200	
spring, removal of	200-201	
tappet adjustment	203-204	
Vehicle		
armament	22-26	
axles		
front	62-65	
rear	66-72	
body	73-78	
brake systems	79-98	
clutch	99-102	
cooling systems		
Buda-Lanova Diesel engine ..	126-128	
gasoline engine	103-117	
Hercules Diesel engine	118-125	
data, tabulated	3-6	
description	8-10	
controls	10-11	
electrical system and accessories		
Diesel engine	175-189	
gasoline engine	129-174	
engines (<i>See specific names</i>)		
frame	294	
fuel system and accessories	295-305	
inspection	34	
maintenance operations, scope of ..	52-55	
materiel affected by gas	49-51	
operation instructions	11-21	
shipment and storage	363-368	
tools and equipment on	46-48	
wheels	359-362	
Ventilators, control of	11	
Voltage regulator (Diesel and gasoline engines)		
description	143-144	
failure in operation	148	
filter	148-149	

SCOUT CAR M3A1

INDEX

V—Cont'd	Page No.	Page No.
Voltage regulator (Diesel and gasoline engines) — Cont'd		
installation	146-148	Water, shipment by..... 365-366
removal	144-146	Water temperature gage..... 330
Voltage regulator relay (Diesel and gasoline engines)	144	Weapons and mounts..... 22
Voltmeter		Wheel and tire assemblies
description of	332	axles
gasoline engine	171	front, removal and positioning of
check	129-132	to chassis
		rear, installation and removal of
		Wheel bearings
		adjustments
		installation and removal of.....
		Wheels
		description
		maintenance and adjust-
		ments
		trouble shooting
		wheel bearings
		Windshield, description of.....
		8
		Windshield wipers
		control of
		description of
		installation of
		removal of
		trouble shooting
		Wood parts, cleaning.....
		43

W

Wandering (axle, front).....	57
Warm up of engines (See Starting and warming up)	
Water pump (cooling system)	
Buda-Lanova Diesel engine.....	127
gasoline engine	
description	111
installation	114-115
lubrication	112
removal	112-114
servicing	111-112
Hercules Diesel engine	
description	122
installation	123
lubrication	124
removal	122-123
servicing	123

[A. G. 062.11 (8-11-42)
 O. O. 461/21502 O. O. (8-11-42)]

BY ORDER OF THE SECRETARY OF WAR:

G. C. MARSHALL,
Chief of Staff.

OFFICIAL:

J. A. ULIO,
*Major General,
 The Adjutant General.*

DISTRIBUTION:

R 2 and 6(3); 9(1); IBn 9(1); IC 2, 6, 9 and 17(3)
 (For explanation of symbols, see FM 21-6)